



# 9,000 BTU/H DUCTED HEAT PUMP SYSTEM

SUBMITTAL COVER SHEET

PROJECT NAME \_\_\_\_\_

LOCATION \_\_\_\_\_



ARCHITECT \_\_\_\_\_

ENGINEER \_\_\_\_\_

CONTRACTOR \_\_\_\_\_

REFERENCE \_\_\_\_\_

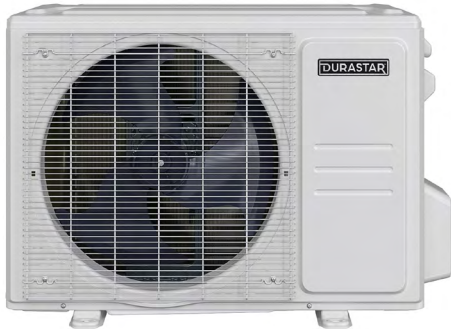
SUBMITTED BY \_\_\_\_\_ DATE \_\_\_\_\_

Indoor Unit (IDU): DRAD09F1A	Outdoor Unit (ODU): DRA1U09S1B	Wired Thermostat
		

## PRODUCT FEATURES

- Wired thermostat included
- Variable Speed Inverter Compressor
- Auto Restart
- Turbo Mode
- 24-Hour Timer Feature
- Quiet operation
- 46°F Freeze Protection
- Low ambient cooling and heating down to -13 °F
- Low ambient cooling down to 5 °F
- Included base pan heater
- Refrigerant leak detection
- Anti-corrosive fin coating

CAPACITIES		
Cooling Capacity (BTU/hr)	Rated at 95 °F	9000
	Minimum	2220
	Maximum	11600
Heating Capacity (BTU/hr)	Rated at 47 °F	10000
	Maximum at 5 °F	8499
	Minimum	2240
	Maximum	13350

SYSTEM DATA	
Refrigerant Type	R-410A
Refrigerant Charge (oz.)	38.1
Design Pressure (PSIG)	550/340
Indoor/ Outdoor Coil Coating	Golden Fin Coating

EFFICIENCY DATA	
SEER2	19.20
EER2	12.50
HSPF2	10.20
SEER	21.00
EER	13.50
HSPF	11.50
COP at 47 °F	3.76
COP at 5 °F	2.38





# 9,000 BTU/H DUCTED HEAT PUMP SYSTEM

## SPECIFICATIONS

LINE SET REQUIREMENTS	
Connection Type	Flare
Liquid	Ø1/4" (Ø6.35mm)
Gas	Ø3/8" (Ø9.52mm)
Pre-Charge Length	25'
Minimum Length	10'
Maximum Length	82'
Maximum Height Differential	33'
Additional Refrigerant (oz./ft)	0.16

OUTDOOR UNIT		
Unit Dimensions	Width	30 1/8"
	Depth	11 15/16"
	Height	21 7/8"
Carton Dimensions	Width	34 15/16"
	Depth	13 1/4"
	Height	24"
Net Weight	63.7 lbs.	
Gross Weight	69.0 lbs.	
Cooling Operating Temperature	5 °F - 122 °F	
Heating Operating Temperature	-13 °F - 75 °F	
Voltage/Phase/Frequency	208-230V, 1 Phase, 60 Hz	
Voltage Range	187-253V	
Recommended Breaker (Amps)	15	
Minimum Circuit Ampacity (Amps)	13	
Communication Wire Size	14*4 AWG Stranded	
Rated Current - Cooling (Amps) <sup>1</sup>	3.05	
Rated Current - Heating (Amps) <sup>2</sup>	3.57	
Sound Pressure (dB(A))	53	

COMPRESSOR	
Type	DC Rotary Inverter
Oil Type	Ester Oil VG74
Oil Charge (oz.)	10.5 (310 ml)

INDOOR UNIT		
Unit Dimensions	Width	27 9/16"
	Depth	19 15/16"
	Height	7 7/8"
Carton Dimensions	Width	33 7/8"
	Depth	21 1/4"
	Height	11"
Net Weight	37.5 lbs.	
Gross Weight	48.3 lbs.	
Indoor Unit Air Flow (CFM)	Low	177
	Medium	283
	High	353
Drain Port O.D.	1" (Ø25mm)	
Drain Pump Lift	21 5/8"	
Recommended Breaker (Amps)	15	
Sound Pressure (dB(A))	Low	27
	Medium	28.5
	High	33.5

<sup>1</sup> Measured at 95 °F.

<sup>2</sup> Measured at 47 °F.

Specifications are subject to change without notice.

© 2022 Ferguson Enterprises LLC

www.durastar.com



# 9,000 BTU/H DUCTED HEAT PUMP SYSTEM

IDU DIMENSIONS - DRAD09F1A

## Unit and air outlet dimensions

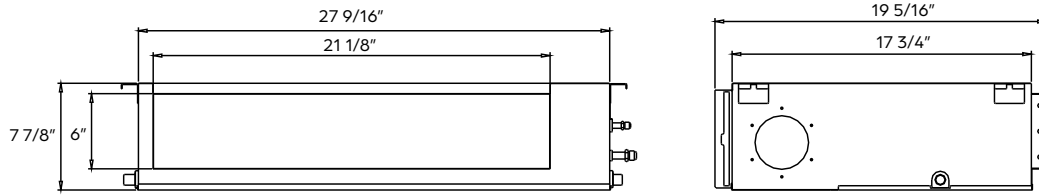

## Air inlet dimensions

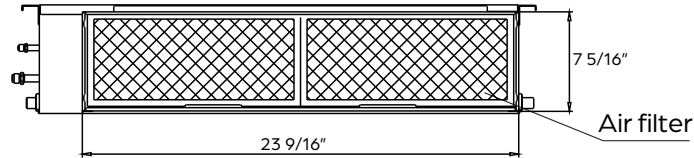

## Mounting dimensions for ceiling bolts

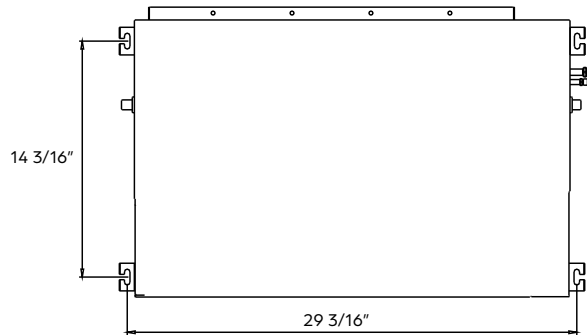

## Installation clearances

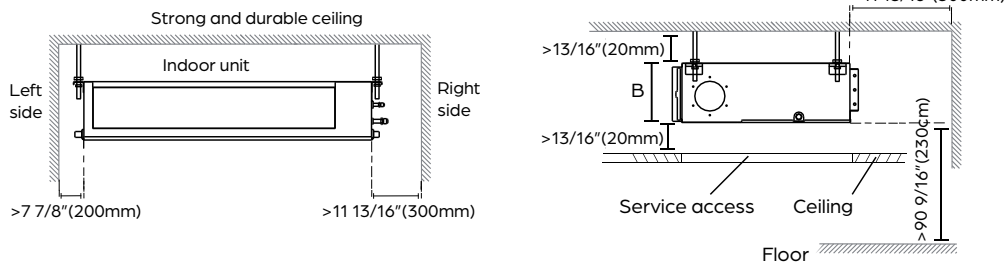

## Maintenance access panel

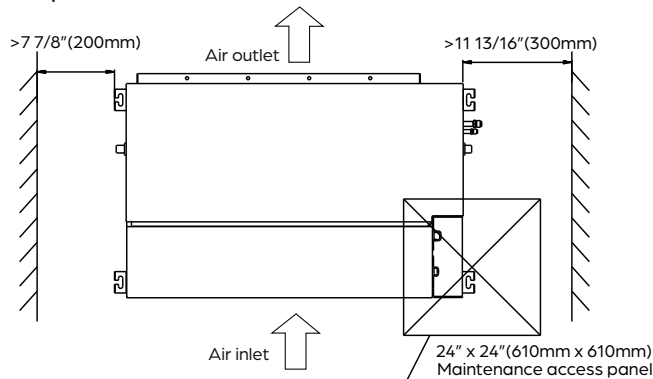



# 9,000 BTU/H DUCTED HEAT PUMP SYSTEM

ODU DIMENSIONS - DRA1U09S1B

## Clearances

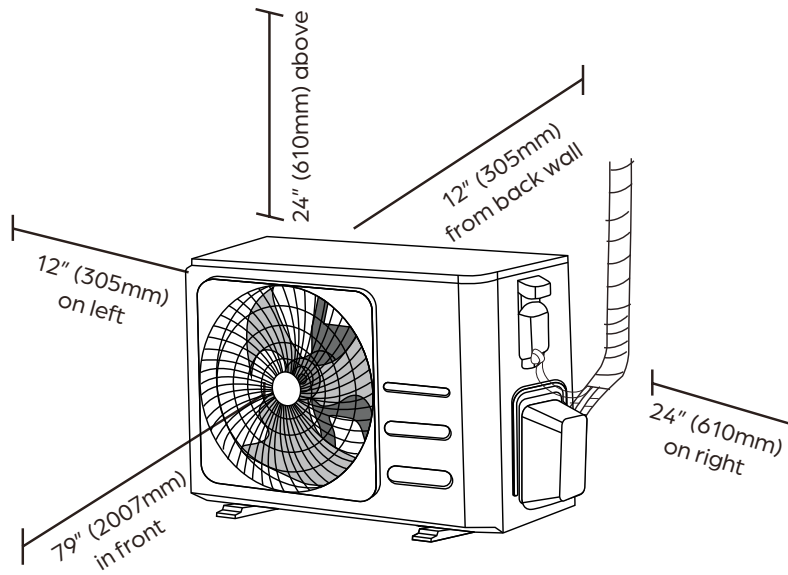

## Dimensions

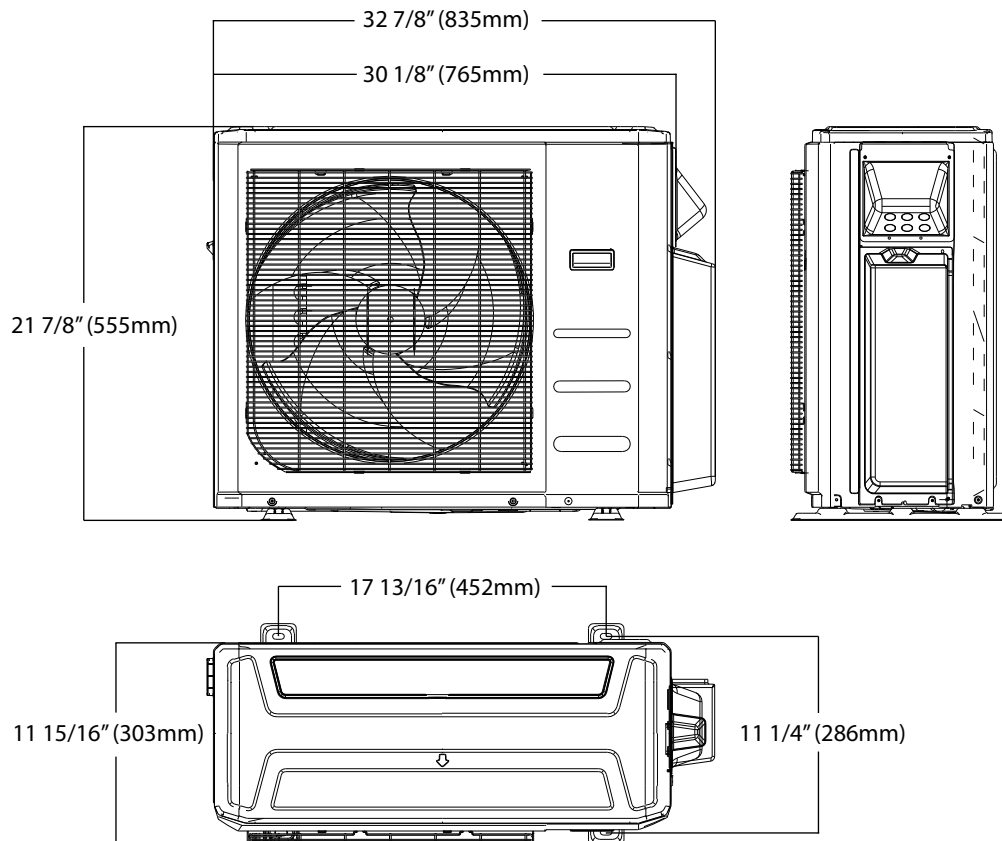

### NOTE

Illustrations in this document are for explanatory purposes. The actual shape of your mini-split equipment may vary slightly.