

Revision B:

• MSZ-EF09/12/15/18NAW/B/S- **U2** have been added.

OBH736 REVISED EDITION-A is void.

INDOOR UNIT

SERVICE MANUAL

**No. OBH736
REVISED EDITION-B**

Models

MSZ-EF09NAW - U1 , U2	MSZ-EF12NAW - U1 , U2
MSZ-EF15NAW - U1 , U2	MSZ-EF18NAW - U1 , U2
MSZ-EF09NAB - U1 , U2	MSZ-EF12NAB - U1 , U2
MSZ-EF15NAB - U1 , U2	MSZ-EF18NAB - U1 , U2
MSZ-EF09NAS - U1 , U2	MSZ-EF12NAS - U1 , U2
MSZ-EF15NAS - U1 , U2	MSZ-EF18NAS - U1 , U2

Outdoor unit service manual
MXZ- ·C·NA(HZ) Series (OCH573)

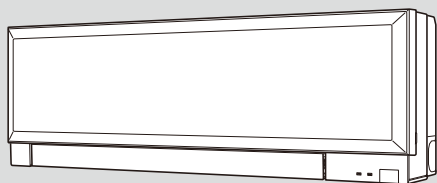

CONTENTS

1. TECHNICAL CHANGES	2
2. PART NAMES AND FUNCTIONS	3
3. SPECIFICATION	4
4. OUTLINES AND DIMENSIONS	6
5. WIRING DIAGRAM	7
6. REFRIGERANT SYSTEM DIAGRAM	8
7. SERVICE FUNCTIONS	9
8. MICROPROCESSOR CONTROL	11
9. TROUBLESHOOTING	19
10. DISASSEMBLY INSTRUCTIONS	31

PARTS CATALOG (OBB736)

Use the specified refrigerant only

Never use any refrigerant other than that specified.

Doing so may cause a burst, an explosion, or fire when the unit is being used, serviced, or disposed of.

Correct refrigerant is specified in the manuals and on the spec labels provided with our products.

We will not be held responsible for mechanical failure, system malfunction, unit breakdown or accidents caused by failure to follow the instructions.

<Preparation before the repair service>

- Prepare the proper tools.
- Prepare the proper protectors.
- Provide adequate ventilation.
- After stopping the operation of the air conditioner, turn off the power-supply breaker and pull the power plug.
- Discharge the capacitor before the work involving the electric parts.

<Precautions during the repair service>

- Do not perform the work involving the electric parts with wet hands.
- Do not pour water into the electric parts.
- Do not touch the refrigerant.
- Do not touch the hot or cold areas in the refrigeration cycle.
- When the repair or the inspection of the circuit needs to be done without turning off the power, exercise great caution not to touch the live parts.

WARNING

When the refrigeration circuit has a leak, do not execute pump down with the compressor.

When pumping down the refrigerant, stop the compressor before disconnecting the refrigerant pipes. The compressor may burst if air etc. get into it.

Revision A:

- 4. OUTLINES AND DIMENSIONS has been modified.
- Some descriptions have been modified.

Revision B:

- MSZ-EF09/12/15/18NAW/B/S-  have been added.

1 TECHNICAL CHANGES

MSZ-EF09NAW -  MSZ-EF12NAW -  MSZ-EF15NAW -  MSZ-EF18NAW - 

MSZ-EF09NAB -  MSZ-EF12NAB -  MSZ-EF15NAB -  MSZ-EF18NAB - 

MSZ-EF09NAS -  MSZ-EF12NAS -  MSZ-EF15NAS -  MSZ-EF18NAS - 

1. New model

MSZ-EF09NAW -  → MSZ-EF09NAW - 

MSZ-EF09NAB -  → MSZ-EF09NAB - 

MSZ-EF09NAS -  → MSZ-EF09NAS - 

MSZ-EF12NAW -  → MSZ-EF12NAW - 

MSZ-EF12NAB -  → MSZ-EF12NAB - 

MSZ-EF12NAS -  → MSZ-EF12NAS - 

MSZ-EF15NAW -  → MSZ-EF15NAW - 

MSZ-EF15NAB -  → MSZ-EF15NAB - 

MSZ-EF15NAS -  → MSZ-EF15NAS - 

MSZ-EF18NAW -  → MSZ-EF18NAW - 

MSZ-EF18NAB -  → MSZ-EF18NAB - 

MSZ-EF18NAS -  → MSZ-EF18NAS - 

1. Model name has been changed.

2

PART NAMES AND FUNCTIONS

MSZ-EF09NAW
MSZ-EF09NAB
MSZ-EF09NAS

MSZ-EF12NAW
MSZ-EF12NAB
MSZ-EF12NAS

MSZ-EF15NAW
MSZ-EF15NAB
MSZ-EF15NAS

MSZ-EF18NAW
MSZ-EF18NAB
MSZ-EF18NAS

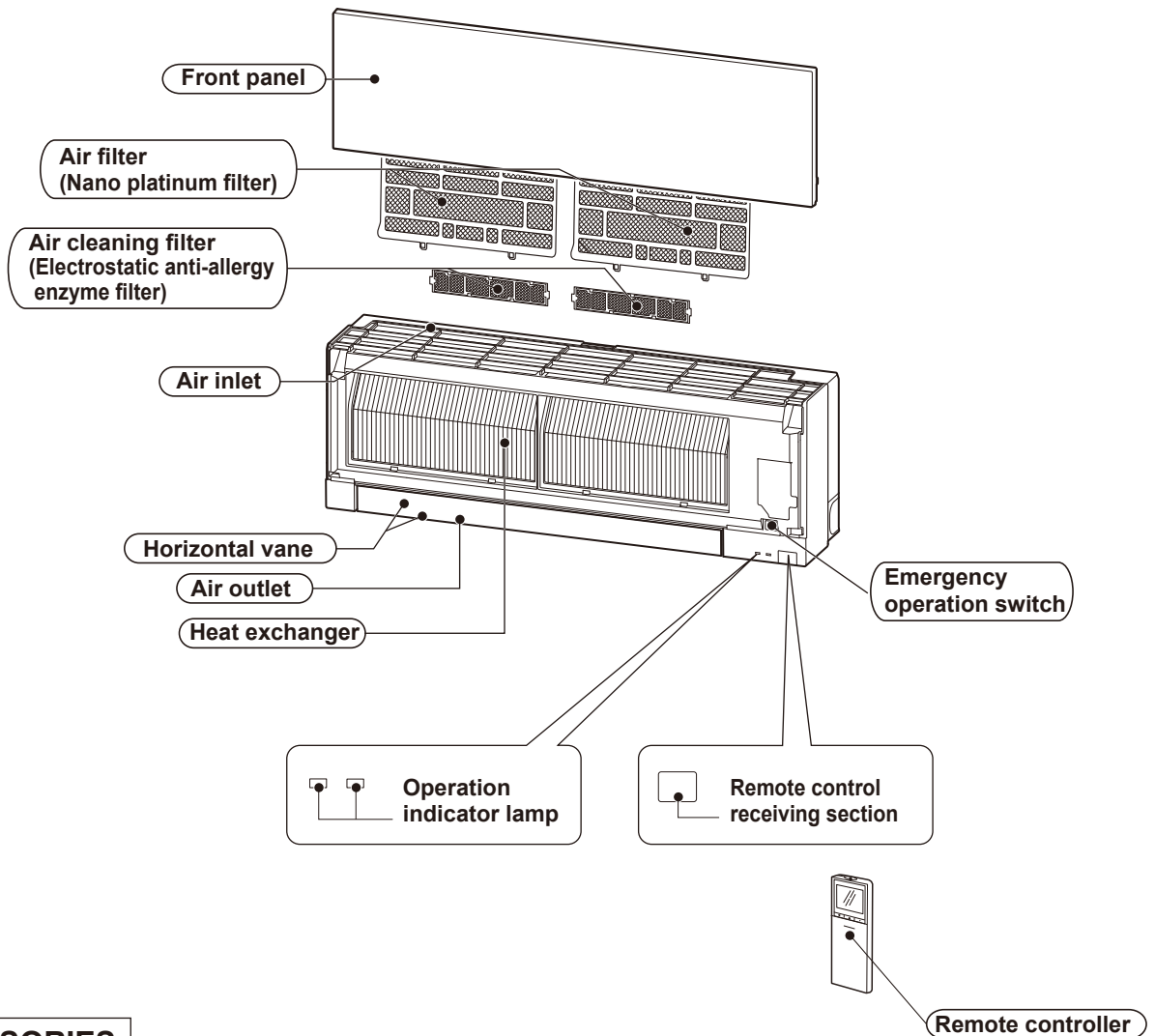

ACCESSORIES

Model	MSZ-EF09NAW	MSZ-EF12NAW	MSZ-EF15NAW	MSZ-EF18NAW
	MSZ-EF09NAB	MSZ-EF12NAB	MSZ-EF15NAB	MSZ-EF18NAB
	MSZ-EF09NAS	MSZ-EF12NAS	MSZ-EF15NAS	MSZ-EF18NAS
① Installation plate			1	
② Installation plate fixing screw 4 × 25 mm			5	
③ Remote controller holder			1	
④ Fixing screw for ③ 3.5 × 16 mm (Black)			2	
⑤ Battery (AAA) for remote controller			2	
⑥ Wireless remote controller			1	
⑦ Felt tape (For left or left-rear piping)			1	
⑧ Soft dry cloth (NAB type only)			1	
⑨ Air cleaning filter			2	

3

SPECIFICATION

Indoor unit model		MSZ-EF09NAW MSZ-EF09NAB MSZ-EF09NAS	MSZ-EF12NAW MSZ-EF12NAB MSZ-EF12NAS	MSZ-EF15NAW MSZ-EF15NAB MSZ-EF15NAS	MSZ-EF18NAW MSZ-EF18NAB MSZ-EF18NAS	
Power supply	V, phase, Hz	208/230 , 1 , 60				
Disconnect switch	A	15				
Min. circuit ampacity	A	1.0				
Fan motor	F.L.A	0.67				
Airflow Super high - High - Med. - Low - Quiet	COOL Dry (Wet)	CFM	371 - 293 - 222 - 162 - 141 (319 - 252 - 191 - 140 - 121)	371 - 293 - 222 - 162 - 141 (319 - 252 - 191 - 140 - 121)	364 - 314 - 272 - 233 - 205 (313 - 270 - 234 - 200 - 176)	388 - 328 - 279 - 240 - 205 (334 - 282 - 240 - 206 - 176)
	HEAT Dry	CFM	420 - 314 - 219 - 162 - 141	448 - 314 - 219 - 162 - 141	448 - 350 - 275 - 222 - 194	466 - 392 - 318 - 258 - 226
Moisture removal	pt./h	0.6	2.1	3.6	4.4	
Sound level Super high - High - Med. - Low - Quiet	Cooling	dB(A)	42 - 36 - 29 - 23 - 21	42 - 36 - 29 - 24 - 21	42 - 39 - 35 - 31 - 28	43 - 40 - 36 - 33 - 30
	Heating	dB(A)	45 - 37 - 29 - 24 - 21	46 - 38 - 30 - 24 - 21	48 - 41 - 35 - 30 - 28	49 - 43 - 37 - 33 - 30
Cond. drain connection O.D.	in.	5/8				
Dimensions	W	34-13/16				
	D	in.	7-11/16			
	H	11-3/4				
Weight	lb.	26				
External finish	W: Munsell 1.0Y 9.2/0.2 B: Munsell 3.7PB 2.0/0.1 S: Munsell 3.1PB 8.2/0.2					
Remote controller	Wireless type					
Control voltage (by built-in transformer)	12 - 24 V DC					

NOTE: Test conditions are based on AHRI 210/240.

3-1. OPERATING RANGE

(1) POWER SUPPLY

	Rated voltage	Guaranteed voltage (V)
Indoor unit	208/230 V 1 phase 60 Hz	Min. 187 208 230 Max. 253

(2) OPERATION

Mode	Condition	Intake air temperature (°F)			
		Indoor		Outdoor	
		DB	WB	DB	WB
Cooling	Standard temperature	80	67	95	—
	Maximum temperature	90	73	115	—
	Minimum temperature	67	57	14	—
	Maximum humidity	78%		—	
Heating	Standard temperature	70	60	47	43
	Maximum temperature	80	67	75	65
	Minimum temperature	70	60	-13	-14

3-2. OUTLET AIR SPEED AND COVERAGE

Model	Mode	Function	Airflow (CFM)	Air speed (ft./s)	Coverage (ft.)
MSZ-EF09NAW MSZ-EF09NAB MSZ-EF09NAS	HEAT	Dry	420	19.5	29.2
	COOL	Dry	371	17.2	25.8
		Wet	319	15.5	23.3
MSZ-EF12NAW MSZ-EF12NAB MSZ-EF12NAS	HEAT	Dry	448	20.8	31.1
	COOL	Dry	371	17.2	25.8
		Wet	319	15.5	23.3
MSZ-EF15NAW MSZ-EF15NAB MSZ-EF15NAS	HEAT	Dry	448	20.8	31.1
	COOL	Dry	364	16.8	25.4
		Wet	313	15.2	22.9
MSZ-EF18NAW MSZ-EF18NAB MSZ-EF18NAS	HEAT	Dry	466	21.6	32.3
	COOL	Dry	388	20.3	30.4
		Wet	336	18.3	27.4

- The air coverage is the figure up to the position where the air speed is 1 ft./s, when air is blown out horizontally from the unit properly at the High speed position.
The coverage should be used only as a general guideline since it varies according to the size of the room and furniture arranged inside the room.

4

OUTLINES AND DIMENSIONS

MSZ-EF09NAW
MSZ-EF09NAB
MSZ-EF09NAS

MSZ-EF12NAW
MSZ-EF12NAB
MSZ-EF12NAS

MSZ-EF15NAW
MSZ-EF15NAB
MSZ-EF15NAS

MSZ-EF18NAW
MSZ-EF18NAB
MSZ-EF18NAS

Unit: inch

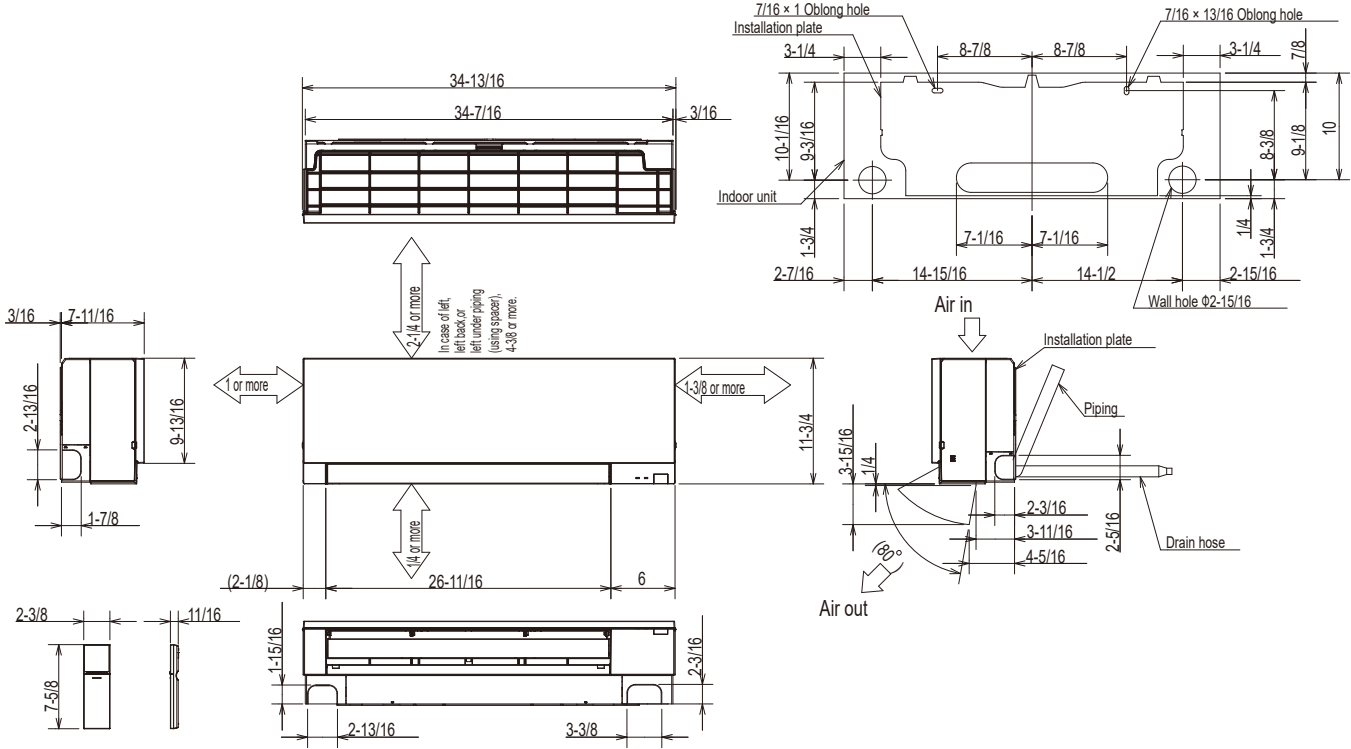

MSZ-EF09/12NA

Piping	Insulation	φ1-7/16 O.D
	Liquid line	φ1/4 - 19-11/16 (Flared connection φ1/4)
	Gas line	φ3/8 - 16-15/16 (Flared connection φ3/8)
	Drain hose	Insulation φ1-1/8 Connected part φ5/8 O.D active length 15-3/8

Note: Extension pipe size refer to the specifications table.

MSZ-EF15/18NA

Piping	Insulation	φ1-7/16 O.D
	Liquid line	φ1/4 - 19-11/16 (Flared connection φ1/4)
	Gas line	φ3/8 - 16-15/16 (Flared connection φ1/2)
	Drain hose	Insulation φ1-1/8 Connected part φ5/8 O.D active length 15-3/8

Note: Extension pipe size refer to the specifications table.

5

WIRING DIAGRAM

MSZ-EF09NAW
MSZ-EF09NAB
MSZ-EF09NAS

MSZ-EF12NAW
MSZ-EF12NAB
MSZ-EF12NAS

MSZ-EF15NAW
MSZ-EF15NAB
MSZ-EF15NAS

MSZ-EF18NAW
MSZ-EF18NAB
MSZ-EF18NAS

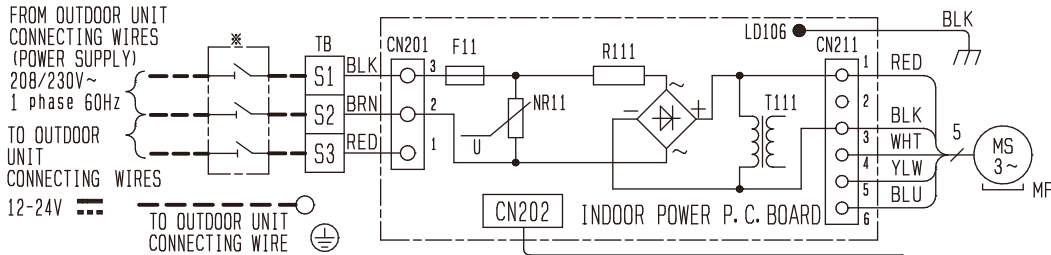

※ A disconnect should be required by local code.
 ※ Se procurer un sectionneur conforme aux réglementations locales.

NOTES: 1. About the outdoor side electric wiring refer to the outdoor unit electric wiring diagram for servicing.

2. Use copper conductors only.

(For field wiring) : Terminal block

3. Symbols indicate. : Connector

REMARQUES: 1. Pour le câblage électronique côté extérieur, se reporter au schéma d'entretien du câblage électronique de l'appareil extérieur.

2. Utiliser des fils d'alimentation en cuivre.

3. Les symboles ont les significations suivantes. : Borne

: Connecteur

SYMBOL	NAME
F11	FUSE (T3. 15AL250V)
MF	FAN MOTOR
MV	VANE MOTOR (HORIZONTAL)
NR11	VARISTOR
R111	RESISTOR
RT11	ROOM TEMP. THERMISTOR
RT12	COIL TEMP. THERMISTOR (MAIN)
RT13	COIL TEMP. THERMISTOR (SUB)
T111	TRANSFORMER
TB	TERMINAL BLOCK

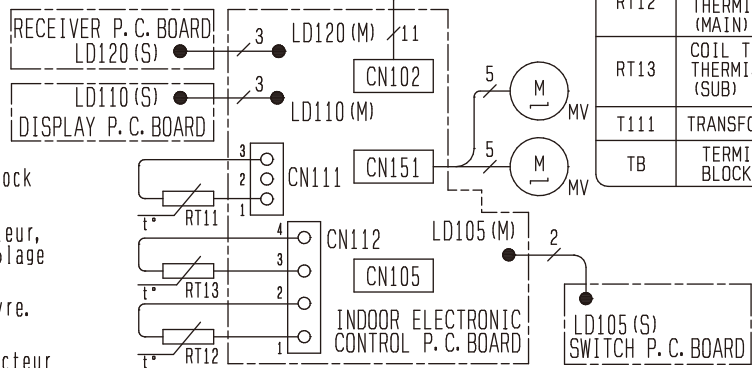

6

REFRIGERANT SYSTEM DIAGRAM

MSZ-EF09NAW
MSZ-EF09NAB
MSZ-EF09NAS

MSZ-EF12NAW
MSZ-EF12NAB
MSZ-EF12NAS

MSZ-EF15NAW
MSZ-EF15NAB
MSZ-EF15NAS

MSZ-EF18NAW
MSZ-EF18NAB
MSZ-EF18NAS

Unit: inch (mm)

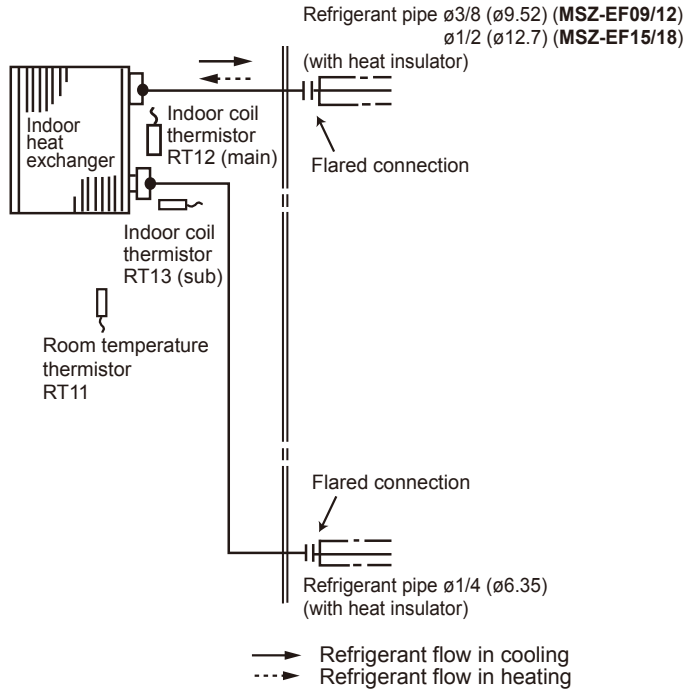

MSZ-EF09NAW

MSZ-EF09NAB

MSZ-EF09NAS

MSZ-EF12NAW

MSZ-EF12NAB

MSZ-EF12NAS

MSZ-EF15NAW

MSZ-EF15NAB

MSZ-EF15NAS

MSZ-EF18NAW

MSZ-EF18NAB

MSZ-EF18NAS

7-1. TIMER SHORT MODE

For service, the following set time can be shortened by bridging JPG and JPS on the electronic control P.C. board.
(Refer to 9-7.)

- The set time for the ON/OFF timer can be reduced to 1 second for each minutes.
- After the breaker is turned on, the time for starting the compressor, which normally takes 3 minutes, can be reduced to 3 seconds. Restarting the compressor, which takes 3 minutes, cannot be reduced.

7-2. HOW TO SET REMOTE CONTROLLER EXCLUSIVELY FOR A PARTICULAR INDOOR UNIT

A maximum of 4 indoor units with wireless remote controllers can be used in a room.

To operate the indoor units individually with each remote controller, assign a number to each remote controller according to the number of the indoor unit.

This setting can be set only when all the following conditions are met:

- The remote controller is powered OFF.
- Weekly timer is not set.
- Weekly timer is not being edited.

(1) Hold down  button on the remote controller for 2 seconds to enter the pairing mode.

(2) Press  button again and assign a number to each remote controller.

Each press of  button advances the number in the following order: 1 → 2 → 3 → 4.

(3) Press  button to complete the pairing setting.

After you turn the breaker ON, the remote controller that first sends a signal to an indoor unit will be regarded as the remote controller for the indoor unit.

Once they are set, the indoor unit will only receive the signal from the assigned remote controller afterwards.

7-3. AUTO RESTART FUNCTION

When the indoor unit is controlled with the remote controller, the operation mode, the set temperature, and the fan speed are memorized by the indoor electronic control P.C. board. "AUTO RESTART FUNCTION" automatically starts operation in the same mode just before the shutoff of the main power.

Operation

- ① If the main power has been cut, the operation settings remain.
- ② After the power is restored, the unit restarts automatically according to the memory.
(However, it takes at least 3 minutes for the compressor to start running.)

How to disable "AUTO RESTART FUNCTION"

- ① Turn off the main power for the unit.
- ② Cut the jumper wire to JR77 on the indoor electronic control P.C. board. (Refer to 9-7.)

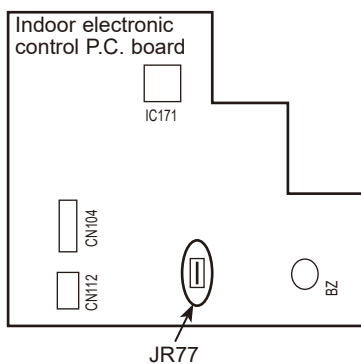

NOTE:

- The operation settings are memorized when 10 seconds have passed after the indoor unit was operated with the remote controller.
- If main power is turned OFF or a power failure occurs while AUTO START/STOP timer is active, the timer setting is cancelled.
- If the unit has been off with the remote controller before power failure, the auto restart function does not work as the power button of the remote controller is OFF.
- To prevent breaker OFF due to the rush of starting current, systematize other home appliance not to turn ON at the same time.
- When some air conditioners are connected to the same supply system, if they are operated before power failure, the starting current of all the compressors may flow simultaneously at restart. Therefore, the special counter-measures are required to prevent the main voltage-drop or the rush of the starting current by adding to the system that allows the units to start one by one.

8

MICROPROCESSOR CONTROL

MSZ-EF09NAW
MSZ-EF09NAB
MSZ-EF09NAS

MSZ-EF12NAW
MSZ-EF12NAB
MSZ-EF12NAS

MSZ-EF15NAW
MSZ-EF15NAB
MSZ-EF15NAS

MSZ-EF18NAW
MSZ-EF18NAB
MSZ-EF18NAS

WIRELESS REMOTE CONTROLLER

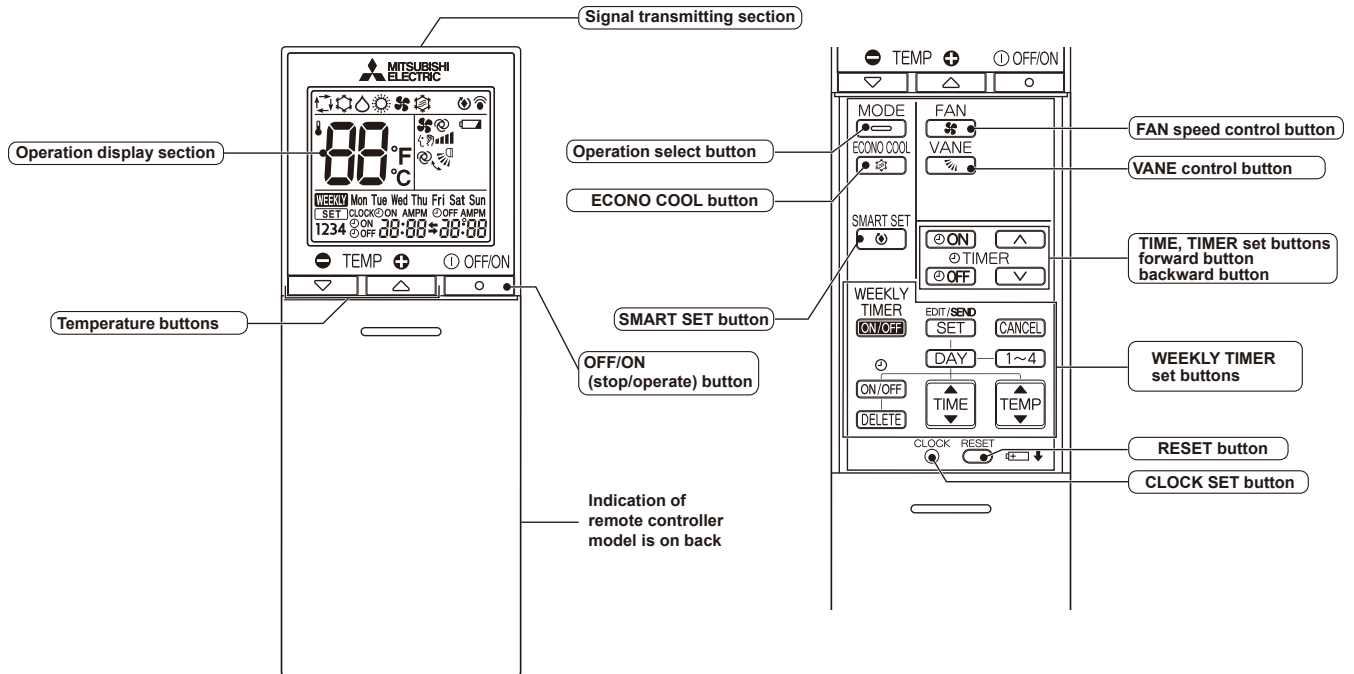

NOTE: Last setting will be stored after the unit is turned OFF with the remote controller. Indoor unit receives the signal of the remote controller with beeps.

INDOOR UNIT DISPLAY SECTION

Operation Indicator lamp

The operation indicator at the right side of the indoor unit indicates the operation state.

•The following indication applies regardless of shape of the indication.

Indication	Operation state	Room temperature
● ●	The unit is operating to reach the set temperature	About 4°F (2°C) or more away from set temperature
● ○	The room temperature is approaching the set temperature	About 2 to 4°F (1 to 2°C) from set temperature
● ●	Standby mode (Only during multi system operation)	—

- Lighted
- Blinking
- Not lighted

8-1. COOL (❄️) OPERATION

- (1) Press OFF/ON (stop/operate) button.
OPERATION INDICATOR lamp of the indoor unit turns on with a beep tone.
- (2) Select COOL mode with Operation select button.
- (3) Press Temperature buttons TEMP \ominus or \oplus button to select the desired temperature.
The setting range is 61 - 88°F (16 - 31°C).

1. Coil frost prevention

The compressor operational frequency is controlled by the temperature of the indoor heat exchanger to prevent the coil from frosting.

When the temperature of indoor heat exchanger becomes too low, the coil frost prevention mode works.

The indoor fan operates at the set speed and the compressor stops. This mode continues until the temperature of indoor heat exchanger rises.

2. Low outside temperature operation

When the outside temperature is lower, low outside temperature operation starts, and the outdoor fan slows or stops.

3. Indoor fan speed control

When the thermostat turns OFF, the indoor fan operates very Low to reduce power consumption.

When the room temperature rises and the thermostat is ON, the indoor fan operates according to the settings on the remote controller.

8-2. DRY (☀️) OPERATION

- (1) Press OFF/ON (stop/operate) button.
OPERATION INDICATOR lamp of the indoor unit turns on with a beep tone.
- (2) Select DRY mode with Operation select button.
- (3) The set temperature is determined from the initial room temperature.

1. Coil frost prevention

Coil frost prevention works the same way as that in COOL mode. (8-1.1.)

2. Low outside temperature operation

Low outside temperature operation works the same way as that in COOL mode. (8-1.2.)

3. Indoor fan speed control

Indoor fan speed control works the same way as that in COOL mode. (8-1.3.)

8-3. FAN (🌀) OPERATION

- (1) OPERATION INDICATOR lamp of the indoor unit turns on with a beep tone.
- (2) Select FAN mode with Operation select button.
- (3) Select the desired fan speed. When AUTO, it becomes Low.
Only indoor fan operates.
Outdoor unit does not operate.

8-4. HEAT (🔥) OPERATION

- (1) Press OFF/ON (stop/operate) button.
OPERATION INDICATOR lamp of the indoor unit turns on with a beep tone.
- (2) Select HEAT mode with Operation select button.
- (3) Press Temperature buttons TEMP \ominus or \oplus button to select the desired temperature.
The setting range is 61 - 88°F (16 - 31°C).

1. Cold air prevention control

When the compressor is not operating or is starting, and the temperature of indoor heat exchanger and/or the room temperature is low or when defrosting is being done, the indoor fan will stop or rotate in Very Low speed.

2. High pressure protection

The compressor operational frequency is controlled by the temperature of the indoor heat exchanger to prevent the condensing pressure from increasing excessively.

When the temperature of indoor heat exchanger becomes too high, the high pressure protection works.

The indoor fan operates following the cold air prevention control. This mode continues until the temperature of indoor heat exchanger falls.

3. Defrosting

Defrosting starts when the temperature of outdoor heat exchanger becomes too low.

The compressor stops once, the indoor/outdoor fans stop, the 4-way valve reverses, and the compressor re-starts.

This mode continues until the temperature of outdoor heat exchanger rises or the fixed time passes.

8-5. AUTO CHANGE OVER ... AUTO MODE OPERATION

Once desired temperature is set, unit operation is switched automatically between COOL and HEAT operation.

Mode selection

(1) Initial mode

When unit starts the operation with AUTO operation from OFF:

- If the room temperature is higher than the set temperature, operation starts in COOL mode.
- If the room temperature is equal to or lower than the set temperature, operation starts in HEAT mode.

(2) Mode change

COOL mode changes to HEAT mode when about 15 minutes have passed with the room temperature 2°F (1°C) below the set temperature.

HEAT mode changes to COOL mode when about 15 minutes have passed with the room temperature 2°F (1°C) above the set temperature.

NOTE 1

If two or more indoor units are operating in multi system, there might be a case that the indoor unit, which is operating in

□ (AUTO), cannot change over to the other operating mode (COOL ↔ HEAT) and becomes a state of standby.

Refer to **NOTE 2 "FOR MULTI SYSTEM AIR CONDITIONER"**.

NOTE 2

FOR MULTI SYSTEM AIR CONDITIONER

OUTDOOR UNIT: MXZ series

Multi system air conditioner can connect two or more indoor units with one outdoor unit.

- When you try to operate 2 or more indoor units with one outdoor unit simultaneously, one for the cooling and the others for heating, the operation mode of the indoor unit that operates first is selected. Other indoor units cannot operate, and operation indicator lamp blinks as shown in the figure below. In this case, please set all the indoor units to the same operation mode.

OPERATION INDICATOR

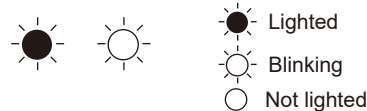

- When indoor unit starts the operation while the defrosting of outdoor unit is being done, it takes a few minutes (max. 10 minutes) to blow out the warm air.
- In the heating operation, though indoor unit that does not operate may get warm or the sound of refrigerant flowing may be heard, they are not malfunction. The reason is that the refrigerant continuously flows into it.

8-6. AUTO VANE OPERATION

1. Horizontal vane

(1) Vane motor drive

These models are equipped with a stepping motors for the horizontal vanes. The rotating direction, speed, and angle of the motor are controlled by pulse signals (approximately 12 V) transmitted from indoor microprocessor.

(2) The horizontal vane angle and mode change as follows by pressing VANE control button.

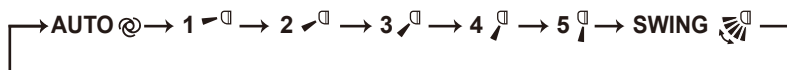

(3) Positioning

To confirm the standard position, the vane move until it touches the vane stopper. Then the vane is set to the selected angle.

Confirming of standard position is performed in the following cases:

- (a) When the operation starts or finishes (including timer operation).
- (b) When the test run starts.
- (c) When standby mode (only during multi system operation) starts or finishes.

(4) VANE AUTO (Ⓢ) mode

In VANE AUTO mode, the microprocessor automatically determines the vane angle to make the optimum room temperature distribution.

In COOL and DRY operation

Vane angle is fixed to Horizontal position.



In HEAT operation

Vane angle is fixed to Angle 4.



(5) STOP (operation OFF) and ON TIMER standby

In the following cases, the horizontal vane returns to the closed position.

- (a) When OFF/ON (stop/operate) button is pressed (POWER OFF).
- (b) When the operation is stopped by the emergency operation.
- (c) When ON TIMER is ON standby.

(6) Dew prevention

During COOL or DRY operation with the vane angle at Angle 4 or 5 when the compressor cumulative operation time exceeds 1 hour, the vane angle automatically changes to Angle 3 for dew prevention.

(7) SWING (🌀) mode

By selecting SWING mode with VANE control button, the horizontal vanes swing vertically.

When COOL, DRY or FAN mode is selected, only the upper vane swings.

(8) Cold air prevention in HEAT operation

The horizontal vane position is set to upward.

NOTE: When 2 or more indoor units are operated with multi outdoor unit, even if any indoor unit turns thermostat off, this control does not work in the indoor unit.

(9) ECONO COOL (🌡️) operation (ECONOmic operation)

When ECONO COOL button is pressed in COOL mode, set temperature is automatically set 4°F (2°C) higher by the microprocessor. However, the temperature on the LCD screen on the remote controller is not changed. Also the horizontal vane swings in various cycle.

SWING operation makes you feel cooler than set temperature. So, even though the set temperature is higher, the air conditioner can keep comfort. As a result, energy can be saved.

To cancel this operation, select a different mode or press one of the following buttons in ECONO COOL operation:

ECONO COOL or VANE control button.

8-7. TIMER OPERATION

1. How to set the time

- (1) Check that the current time is set correctly.

NOTE: Timer operation will not work without setting the current time. Initially "12:00 AM" blinks at the current time display of TIME MONITOR, so set the current time correctly with CLOCK button.

How to set the current time

- (a) Press the CLOCK button.
(b) Press the TIME SET buttons ($\square\wedge$ and $\square\vee$) to set the current time.
• Each time forward button ($\square\wedge$) is pressed, the set time increases by 1 minute, and each time backward button ($\square\vee$) is pressed, the set time decreases by 1 minute.
• Pressing those buttons longer, the set time increases/decreases by 10 minutes.
(c) Press the CLOCK set button.
(2) Press OFF/ON (stop/operate) button to start the air conditioner.
(3) Set the time of timer.

ON timer setting

- (a) Press ON TIMER button (ON) during operation.
(b) Set the time of the timer using TIME SET buttons ($\square\wedge$ and $\square\vee$). *

OFF timer setting

- (a) Press OFF TIMER button (OFF) during operation.
(b) Set the time of the timer using TIME SET buttons ($\square\wedge$ and $\square\vee$). *

* Each time forward button ($\square\wedge$) is pressed, the set time increases by 10 minutes: each time backward button ($\square\vee$) is pressed, the set time decreases by 10 minutes.

2. To release the timer

To release ON timer, press ON TIMER button (ON).

To release OFF timer, press OFF TIMER button (OFF).

TIMER is cancelled and the display of set time disappears.

PROGRAM TIMER

- OFF timer and ON timer can be used in combination. The set time that is reached first will operate first.
- "➡" and "⬅" display shows the order of OFF timer and ON timer operation.

(Example 1) The current time is 8:00 PM.

The unit turns off at 11:00 PM, and on at 6:00 AM.

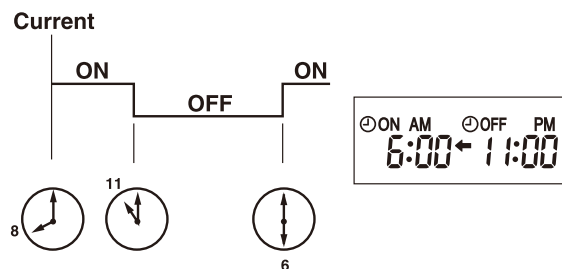

(Example 2) The current time is 11:00 AM.

The unit turns on at 5:00 PM, and off at 9:00 PM.

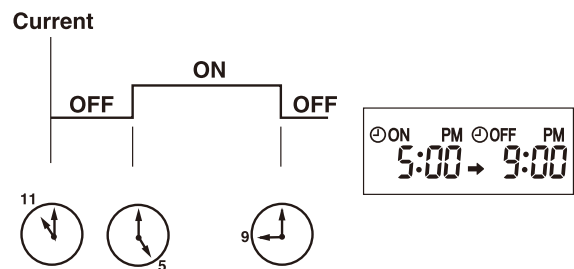

NOTE: If the main power is turned OFF or a power failure occurs while ON/OFF timer is active, the timer setting is cancelled. As these models are equipped with an auto restart function, the air conditioner starts operating with timer cancelled when power is restored.

8-8. WEEKLY TIMER OPERATION

- A maximum of 4 ON or OFF timers can be set for individual days of the week.
- A maximum of 28 ON or OFF timers can be set for a week.

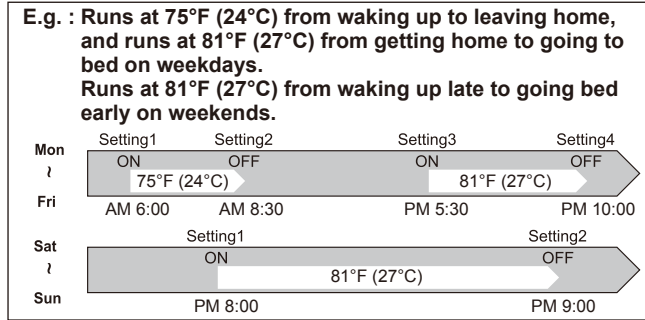

NOTE:

- The simple ON/OFF timer setting is available while the weekly timer is on. In this case, the ON/OFF timer has priority over the weekly timer; the weekly timer operation will start again after the simple ON/OFF timer is complete.
- When the weekly timer is set, temperature can not be set to 50°F (10°C).
- The weekly timer operation and SMART SET operation cannot be used together.

1. How to set the weekly timer

* Make sure that the current time and day are set correctly.

(1) Press **EDIT/SEND** button to enter the weekly timer setting mode.

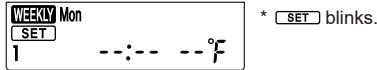

(2) Press **DAY** and **1~4** buttons to select setting day and number.

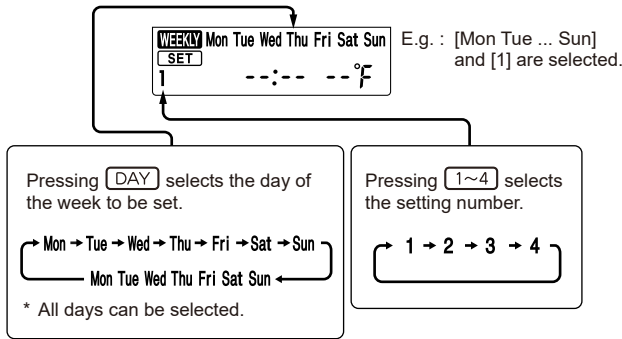

(3) Press **ON/OFF**, **TIME**, and **TEMP** buttons to set ON/OFF, time, and temperature.

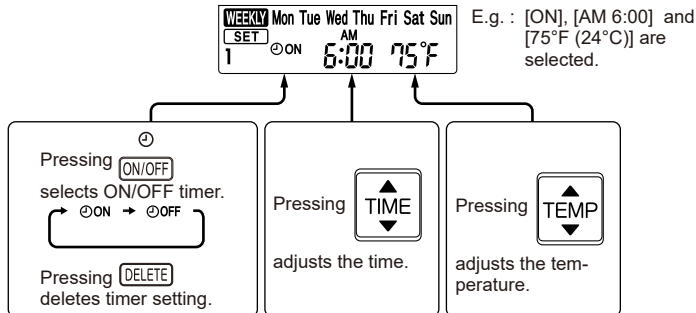

- * Hold down the button to change the time quickly.
- * The temperature can be set between 61°F and 88°F (16°C and 31°C) at weekly timer.





Press **DAY** and **1~4** buttons to continue setting the timer for other days and/or numbers.



(4) Press  button to complete and transmit the weekly timer setting.





*  which was blinking goes out, and the current time will be displayed.

NOTE:

- Press  button to transmit the setting information of weekly timer to the indoor unit. Point the remote controller toward the indoor unit for 3 seconds.
- When setting the timer for more than one day of the week or one number,  button does not have to be pressed per each setting. Press  button once after all the settings are complete. All the weekly timer settings will be saved.
- Press  button to enter the weekly timer setting mode, and press and hold  button for 5 seconds to erase all weekly timer settings. Point the remote controller toward the indoor unit.

(5) Press  button to turn the weekly timer ON. ( lights.)

•When the weekly timer is ON, the day of the week whose timer setting is complete, will light.

Press  button again to turn the weekly timer OFF. ( goes out.)



NOTE:

The saved settings will not be cleared when the weekly timer is turned OFF.

2. Checking weekly timer setting

(1) Press  button to enter the weekly timer setting mode.

*  blinks.

(2) Press  or  buttons to view the setting of the particular day or number.

(3) Press  button to exit the weekly timer setting.

NOTE:

When all days of the week are selected to view the settings and a different setting is included among them,  will be displayed.

8-9. SMART SET (Ⓢ) OPERATION

1. How to set SMART SET operation

- (1) Press OFF/ON (stop/operate) button.
- (2) Select COOL, HEAT or ECONO COOL mode.
- (3) Press SMART SET button.
- (4) Set the temperature, fan speed, and airflow direction for SMART SET operation.

NOTE:

- Select the appropriate temperature, fan speed, and airflow direction according to your room.
- SMART SET operation cannot be selected during DRY or AUTO mode operation.
- The setting range of HEAT mode SMART SET operation is 50°F (10°C) and 61 - 88°F (16 - 31°C).
- 2 groups of setting can be saved. (One for COOL/ECONO COOL, one for HEAT)
- SMART SET operation and the weekly timer operation cannot be used together.

2. How to cancel operation

- Press SMART SET button again.
- SMART SET operation can also be cancelled by pressing Operation select button to change the operation mode. The same setting is select from the next time by simply pressing SMART SET button.
- SMART SET operation cannot be set on the weekly timer.

8-10. EMERGENCY/TEST OPERATION

In the case of test run operation or emergency operation, use Emergency operation switch on the right side of the indoor unit. Emergency operation is available when the remote controller is missing or has failed, or when the batteries in the remote controller are running down. The unit will start and OPERATION INDICATOR lamp will light up. The first 30 minutes of operation is the test run operation. This operation is for servicing. The indoor fan runs at High speed and the temperature control does not work.

After 30 minutes of test run operation, the system shifts to EMERGENCY COOL/HEAT MODE with a set temperature of 75°F (24°C). The fan speed shifts to Medium.

The coil frost prevention works even in the test run or the emergency operation.

In the test run or emergency operation, the horizontal vane operates in VANE AUTO (Ⓢ) mode.

Emergency operation continues until Emergency operation switch is pressed once or twice or the unit receives any signal from the remote controller. In the latter case, normal operation will start.

NOTE: Do not press Emergency operation switch during normal operation.

Operation mode	COOL/HEAT
Set temperature	75°F (24°C)
Fan speed	Med.
Horizontal vane	Auto

The operation mode is indicated by the Operation Indicator lamp as follows.

Operation Indicator lamp

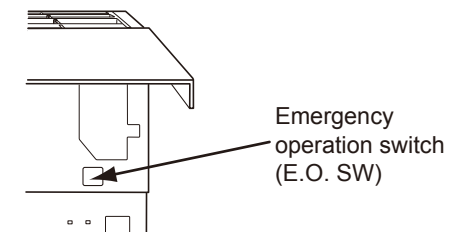
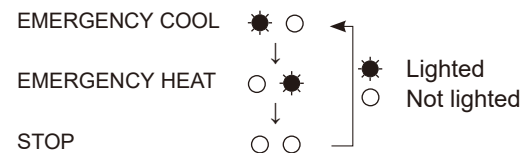

8-11. 3-MINUTE TIME DELAY OPERATION

When the system turns OFF, compressor will not restart for 3 minutes as 3-minute time delay function operates to protect compressor from overload.

8-12. Changing temperature indication (°F/°C)

- The preset unit is °F.
- °F → °C: Press RESET button while the temperature buttons are pressed.
- °C → °F: Press RESET button or remove the batteries .

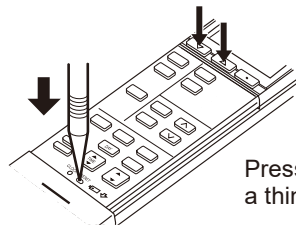

Press RESET button gently using a thin instrument.

MSZ-EF09NAW
MSZ-EF09NAB
MSZ-EF09NAS

MSZ-EF12NAW
MSZ-EF12NAB
MSZ-EF12NAS

MSZ-EF15NAW
MSZ-EF15NAB
MSZ-EF15NAS

MSZ-EF18NAW
MSZ-EF18NAB
MSZ-EF18NAS

9-1. CAUTIONS ON TROUBLESHOOTING

1. Before troubleshooting, check the following

- 1) Check the power supply voltage.
- 2) Check the indoor/outdoor connecting wire for miswiring.

2. Take care of the following during servicing

- 1) Before servicing the air conditioner, be sure to turn OFF the main unit first with the remote controller, and then after confirming the horizontal vane is closed, turn OFF the breaker and/or disconnect the power plug.
- 2) Be sure to turn OFF the power supply before removing the front panel, the cabinet, the top panel, and the P.C. board.
- 3) When removing the P.C. board, hold the edge of the board with care NOT to apply stress on the components.
- 4) When connecting or disconnecting the connectors, hold the connector housing. DO NOT pull the lead wires.

<Incorrect>



Lead wiring

<Correct>



Connector housing

3. Troubleshooting procedure

- 1) Check if the OPERATION INDICATOR lamp on the indoor unit is blinking ON and OFF to indicate an abnormality. To make sure, check how many times the OPERATION INDICATOR lamp is blinking ON and OFF before starting service work.
- 2) Before servicing, verify that all connectors and terminals are connected properly.
- 3) When the electronic control P.C. board seems to be defective, check for disconnection of the copper foil pattern and burnt or discolored components.
- 4) When troubleshooting, Refer to 9-2, 9-3 and 9-4.

4. How to replace batteries

Weak batteries may cause the remote controller malfunction.

In this case, replace the batteries to operate the remote controller normally.

- ① Remove the front lid and insert batteries. Then reattach the front lid.

- ② Press RESET button with a thin instrument, and then use the remote controller.

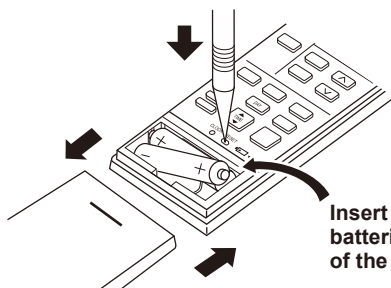

Insert the negative pole of the batteries first. Check if the polarity of the batteries is correct.

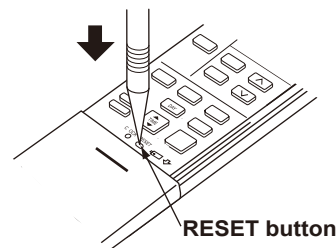

RESET button

NOTE: 1. If RESET button is not pressed, the remote controller may not operate correctly.

2. This remote controller has a circuit to automatically reset the microprocessor when batteries are replaced.

This function is equipped to prevent the microprocessor from malfunctioning due to the voltage drop caused by the battery replacement.

3. Do not use the leaking batteries.

9-2. FAILURE MODE RECALL FUNCTION

Outline of the function

This air conditioner can memorize the abnormal condition which has occurred once.

Even though LED indication listed on the troubleshooting check table (9-4.) disappears, the memorized failure details can be recalled.

1. Flow chart of failure mode recall function for the indoor/outdoor unit

Operational procedure

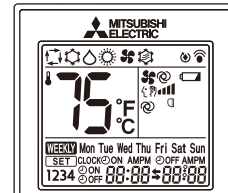
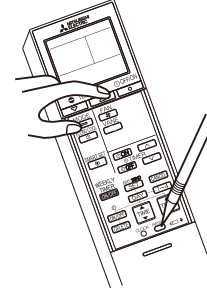
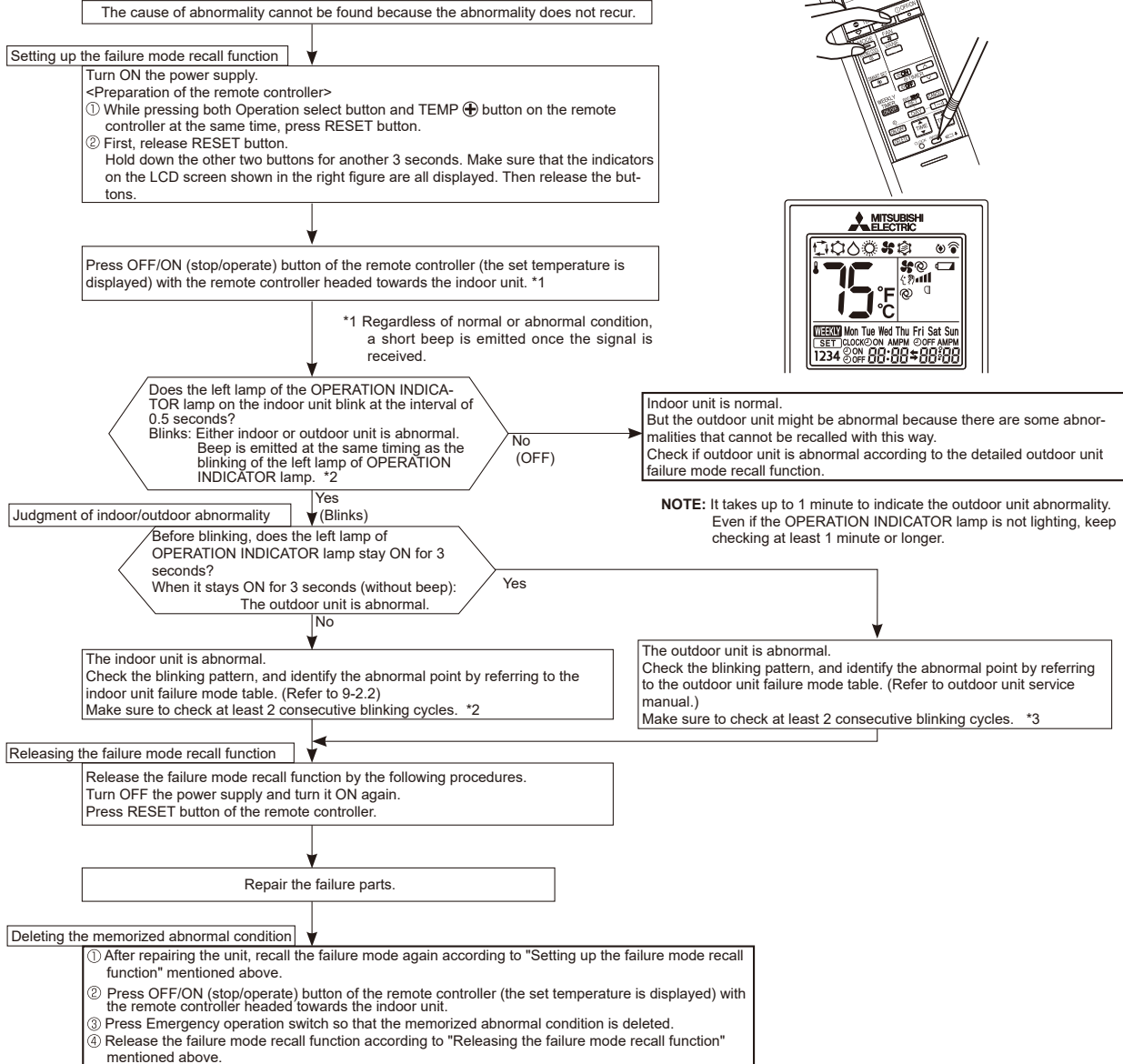

NOTE: It takes up to 1 minute to indicate the outdoor unit abnormality. Even if the OPERATION INDICATOR lamp is not lighting, keep checking at least 1 minute or longer.

NOTE: 1. Make sure to release the failure mode recall function after it is set up, otherwise the unit cannot operate properly.
 2. If the abnormal condition is not deleted from the memory, the last abnormal condition is kept memorized.

*2. Blinking pattern when the indoor unit is abnormal:

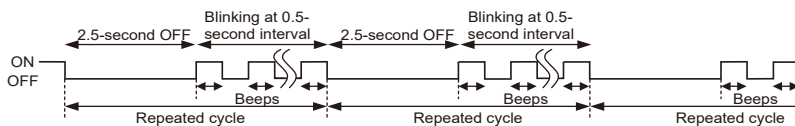

*3. Blinking pattern when the outdoor unit is abnormal:

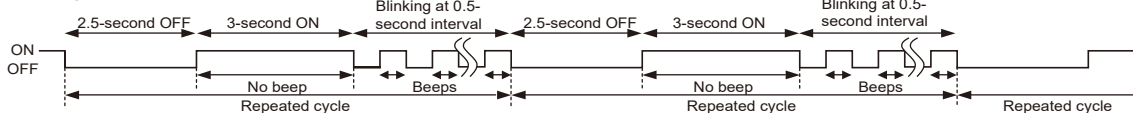

2. Indoor unit failure mode table

The left lamp of the OPERATION INDICATOR lamp	Abnormal point (Failure mode)	Condition	Remedy
Not lighted	Normal	—	—
1-time blink every 0.5-second	Room temperature thermistor	The room temperature thermistor short or open circuit is detected every 8 seconds during operation.	Refer to the characteristics of the room temperature thermistor (9-7.).
2-time blink 2.5-second OFF	Indoor coil thermistor	The indoor coil thermistor short or open circuit is detected every 8 seconds during operation.	Refer to the characteristics of the main indoor coil thermistor, the sub indoor coil thermistor (9-7.).
3-time blink 2.5-second OFF	Serial signal	The serial signal from outdoor unit is not received for a maximum of 6 minutes.	Refer to 9-6.Ⓓ "How to check miswiring and serial signal error".
11-time blink 2.5-second OFF	Indoor fan motor	The rotational frequency feedback signal is not emitted for 12 seconds after the indoor fan motor is operated.	Refer to 9-6.Ⓐ "Check of indoor fan motor".
12-time blink 2.5-second OFF	Indoor control system	It cannot properly read data in the nonvolatile memory of the indoor electronic control P.C. board.	Replace the indoor electronic control P.C. board.

NOTE: Blinking patterns of this mode differ from the ones of TROUBLESHOOTING CHECK TABLE (9-4.).

9-3. INSTRUCTION OF TROUBLESHOOTING

*2 There is possibility that diesel explosion may occur due to the air mixed in the refrigerant circuit. First, ensure that there are no leakage points on the valves, flare connections, etc. that allow the air to flow into the refrigerant circuit, or no blockage points (e.g. clogged or closed valves) in the refrigerant circuit that cause an increase in pressure. If there is no abnormal point like above and the system operates cooling and heating modes normally, the indoor thermistor might have a problem, resulting in false detection. Check both the indoor coil thermistor and the room temperature thermistor, and replace faulty thermistor(s), if any. (Do not start the operation again without repair to prevent hazards.)

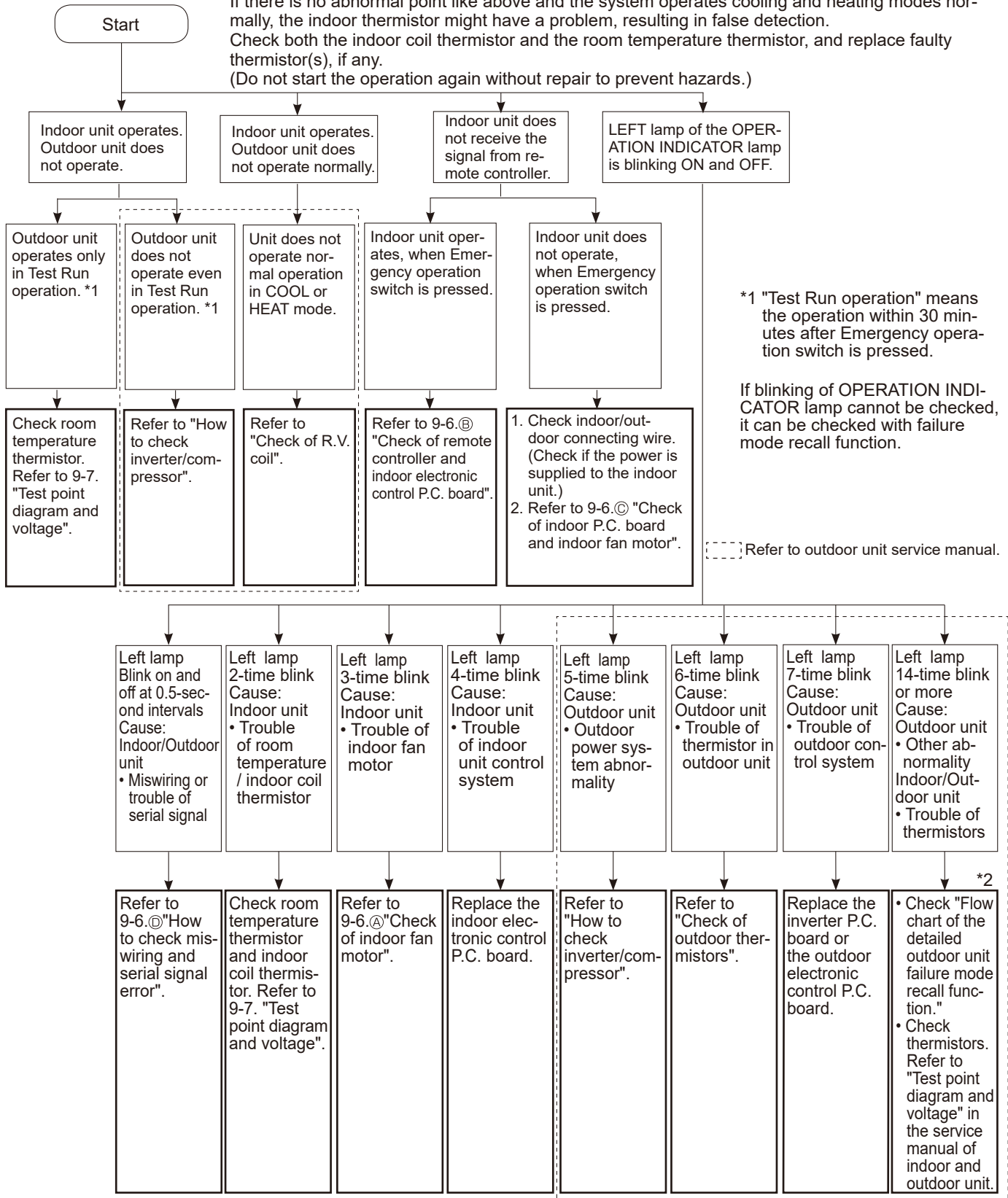

OPERATION INDICATOR



No.	Abnormal point	Operation indicator lamp	Symptom	Condition	Remedy
1	MXZ type Operation mode setting	Left lamp lights and lower lamp blinks. 	Outdoor unit operates but indoor unit does not operate.	The operation mode of the each indoor unit is differently set to COOL (includes DRY) and HEAT at the same time, the operation mode of the indoor unit that has operated at first has the priority.	<ul style="list-style-type: none"> Unify the operation mode. Refer to outdoor unit service manual.

9-5. TROUBLE CRITERION OF MAIN PARTS

MSZ-EF09NAW MSZ-EF12NAW MSZ-EF15NAW MSZ-EF18NAW
MSZ-EF09NAB MSZ-EF12NAB MSZ-EF15NAB MSZ-EF18NAB
MSZ-EF09NAS MSZ-EF12NAS MSZ-EF15NAS MSZ-EF18NAS

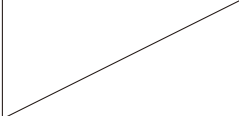
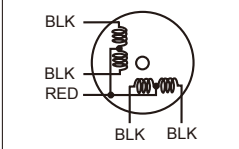
Part name	Check method and criterion	Figure			
Room temperature thermistor (RT11)	Measure the resistance with a tester.				
Indoor coil thermistor (RT12, RT13)	Refer to 9-7. "Test point diagram and voltage", "Indoor electronic control P.C. board", for the chart of thermistor.				
Indoor fan motor (MF)	Check 9-6.Ⓐ "Check of indoor fan motor".				
Vane motor (MV)	Measure the resistance between the terminals with a tester. (Temperature: 50 - 86°F (10 - 30°C)) <table border="1" data-bbox="391 1081 1045 1144"> <thead> <tr> <th>Color of the lead wire</th> <th>Normal</th> </tr> </thead> <tbody> <tr> <td>RED - BLK</td> <td>232 - 268 Ω</td> </tr> </tbody> </table>		Color of the lead wire	Normal	RED - BLK
Color of the lead wire	Normal				
RED - BLK	232 - 268 Ω				

9-6. TROUBLESHOOTING FLOW

A Check of indoor fan motor

The indoor fan motor error has occurred, and the indoor fan does not operate.

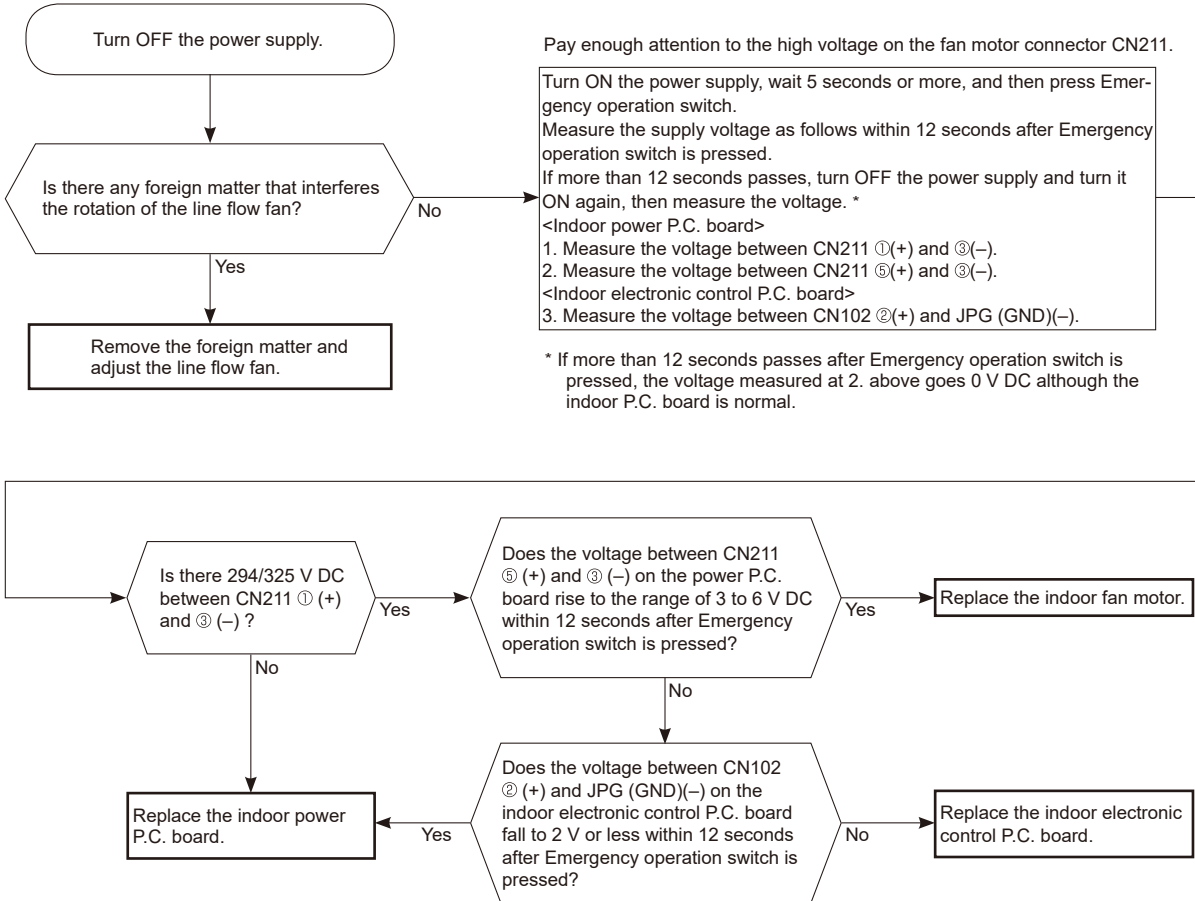

The indoor fan motor error has occurred, and the indoor fan repeats "12-second ON and 30-second OFF" 3 times, and then stops.

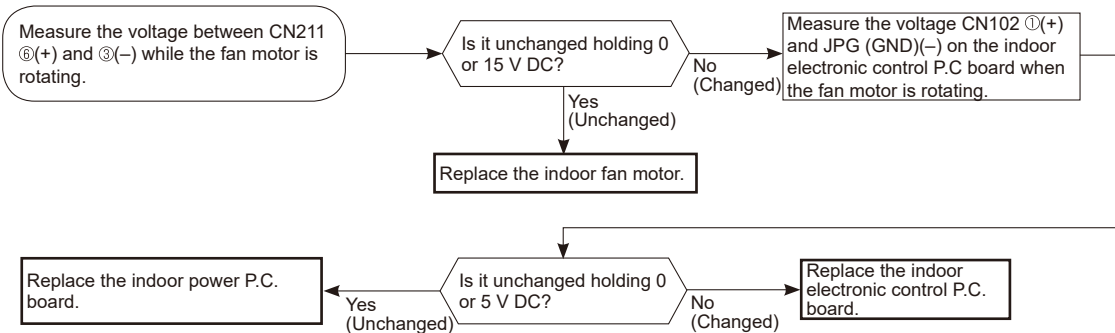

B Check of remote controller and indoor electronic control P.C. board

*Check if the remote controller is exclusive for this air conditioner.

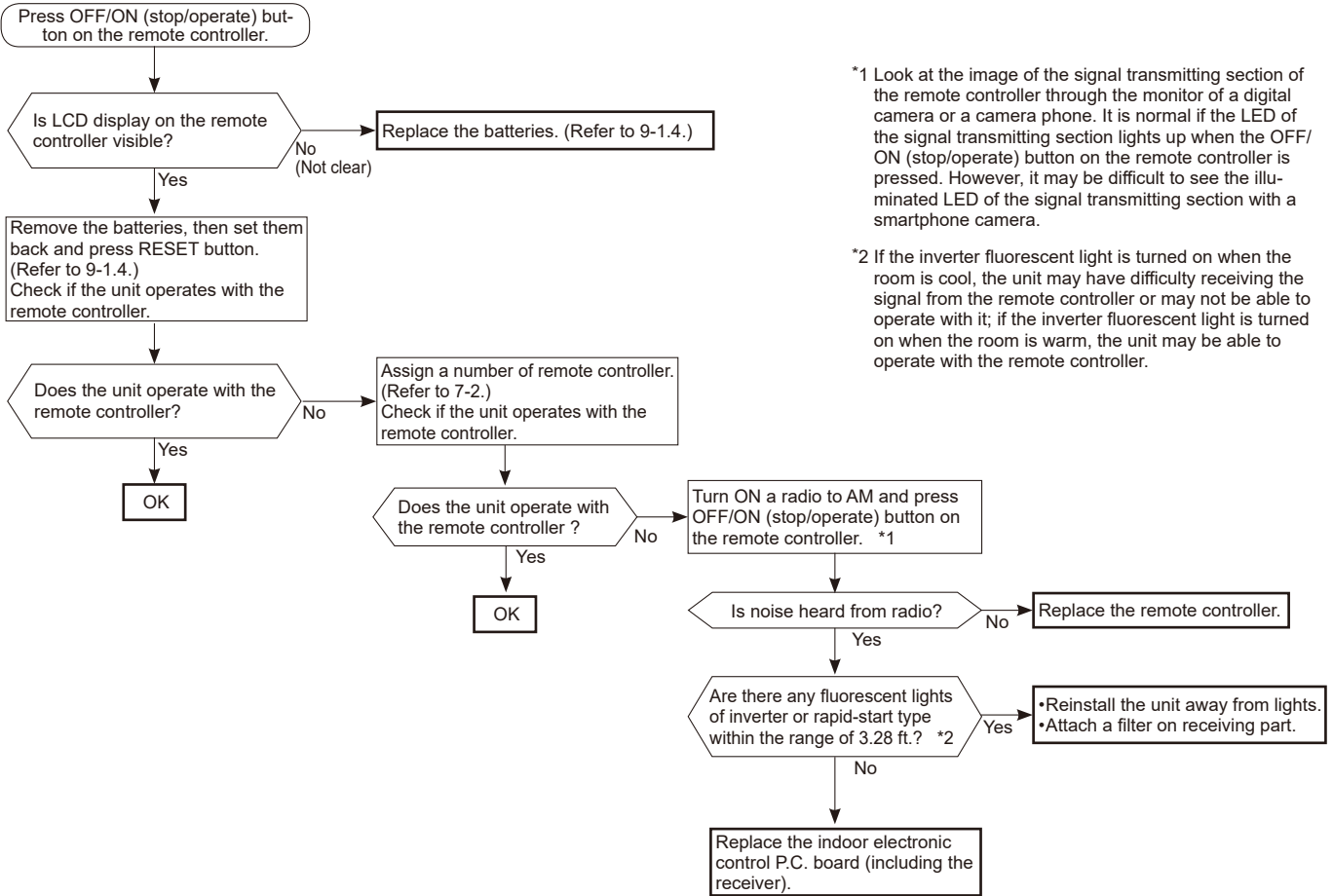

C Check of indoor P.C. board and indoor fan motor

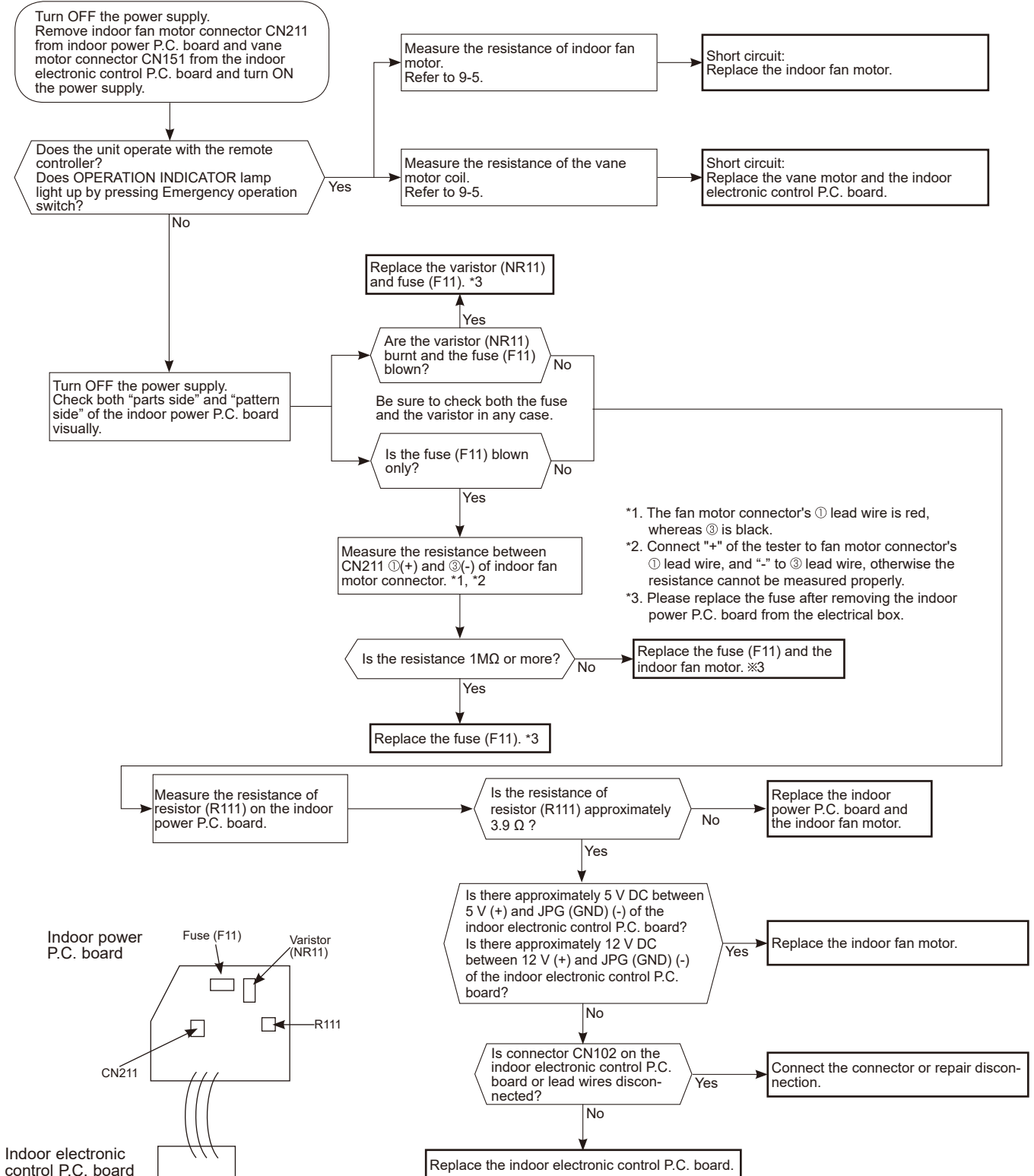

D How to check miswiring and serial signal error

NOTE: Refer to the outdoor unit service manual.

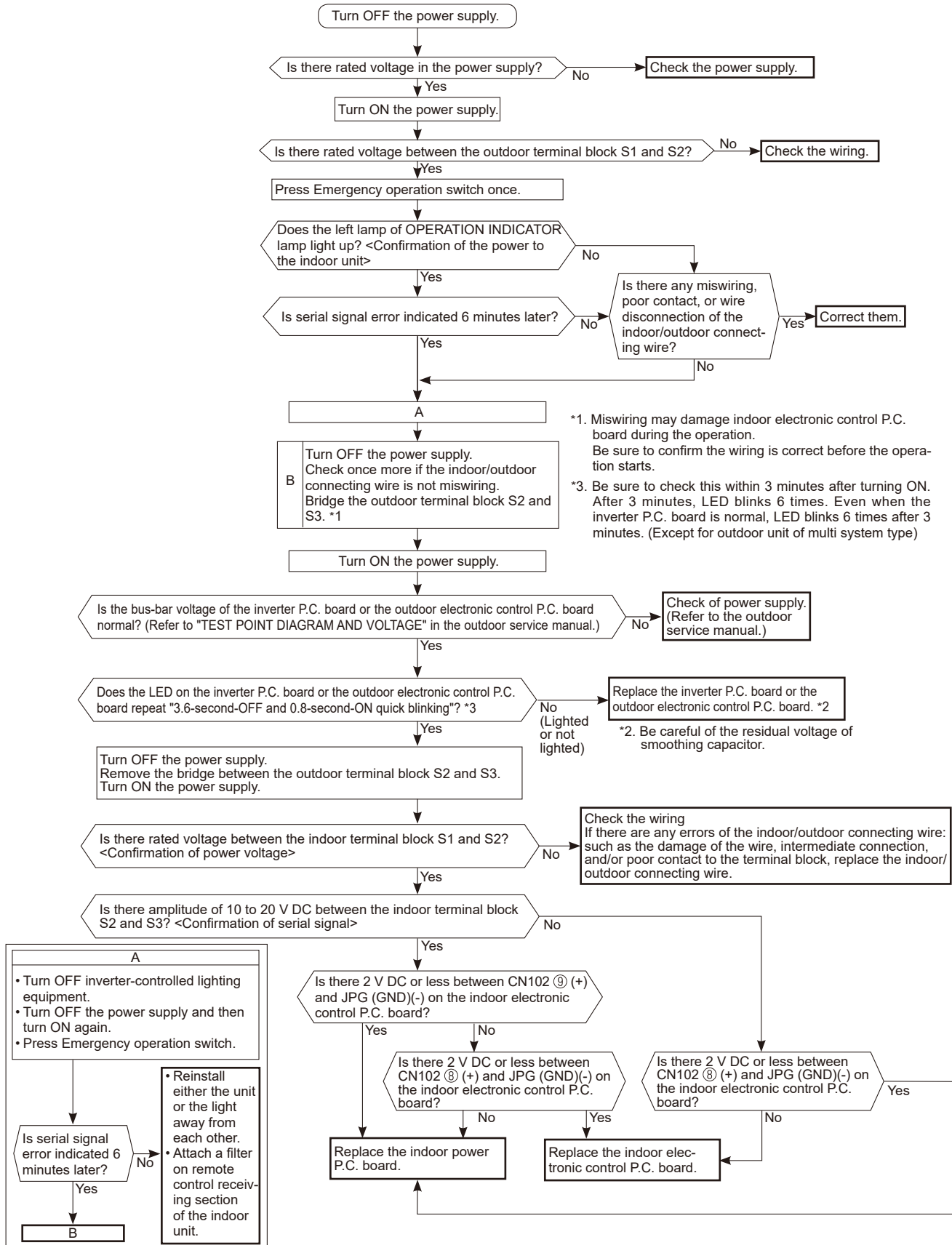

E Electromagnetic noise enters into TV sets or radios

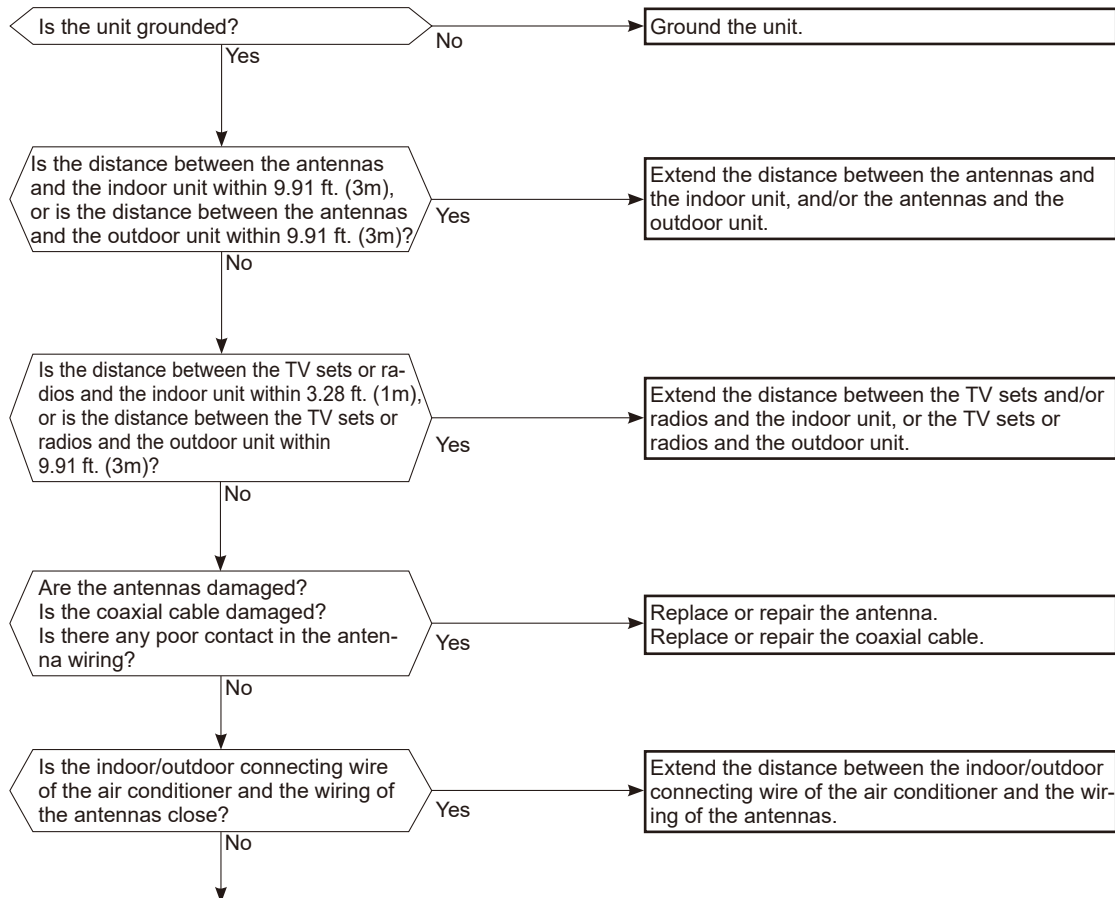

Even if all of the above conditions are fulfilled, the electromagnetic noise may enter, depending on the electric field strength or the installation condition (combination of specific conditions such as antennas or wiring).
 Check the following before asking for service.

1. Devices affected by the electromagnetic noise
 TV sets, radios (FM/AM broadcast, shortwave)
2. Channel, frequency, broadcast station affected by the electromagnetic noise
3. Channel, frequency, broadcast station unaffected by the electromagnetic noise
4. Layout of:
 indoor/outdoor unit of the air conditioner, indoor/outdoor wiring, ground wire, antennas, wiring from antennas, receiver
5. Electric field intensity of the broadcast station affected by the electromagnetic noise
6. Presence or absence of amplifier such as booster
7. Operation condition of air conditioner when the electromagnetic noise enters in
 - 1) Turn OFF the power supply once, and then turn ON the power supply. In this situation, check for the electromagnetic noise.
 - 2) Within 3 minutes after turning ON the power supply, press OFF/ON (stop/operate) button on the remote controller for power ON, and check for the electromagnetic noise.
 - 3) After a short time (3 minutes later after turning ON), the outdoor unit starts running. During operation, check for the electromagnetic noise.
 - 4) Press OFF/ON (stop/operate) button on the remote controller for power OFF, when the outdoor unit stops but the indoor/outdoor communication still runs on. In this situation, check for the electromagnetic noise.

9-7. TEST POINT DIAGRAM AND VOLTAGE
MSZ-EF09NAW MSZ-EF12NAW MSZ-EF15NAW MSZ-EF18NAW
MSZ-EF09NAB MSZ-EF12NAB MSZ-EF15NAB MSZ-EF18NAB
MSZ-EF09NAS MSZ-EF12NAS MSZ-EF15NAS MSZ-EF18NAS

Indoor power P.C. board

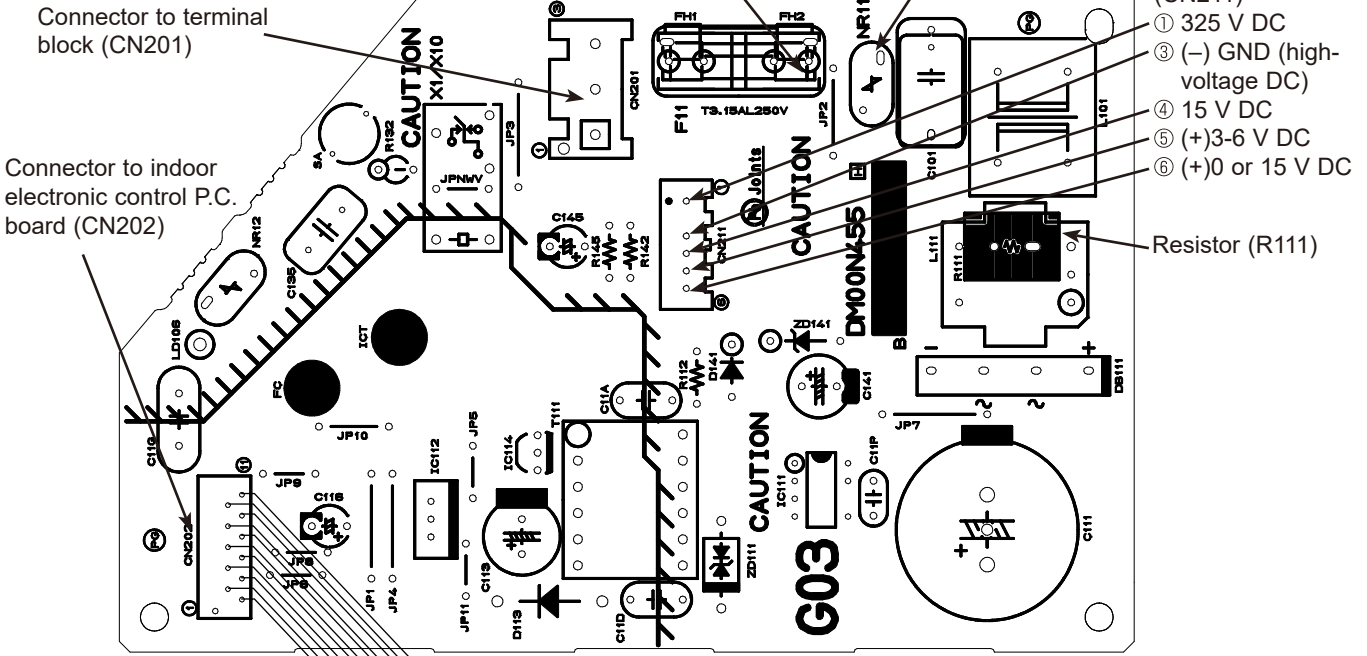

- Indoor fan motor (CN211)
- ① 325 V DC
 - ③ (-) GND (high-voltage DC)
 - ④ 15 V DC
 - ⑤ (+)3-6 V DC
 - ⑥ (+)0 or 15 V DC

Indoor electronic control P.C. board

Receiver board

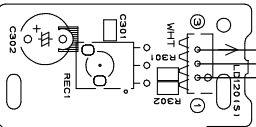

Vane motor (CN151)

Display board

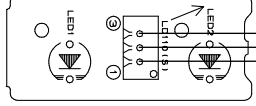

Room temperature thermistor RT11 (CN111)

Switch board

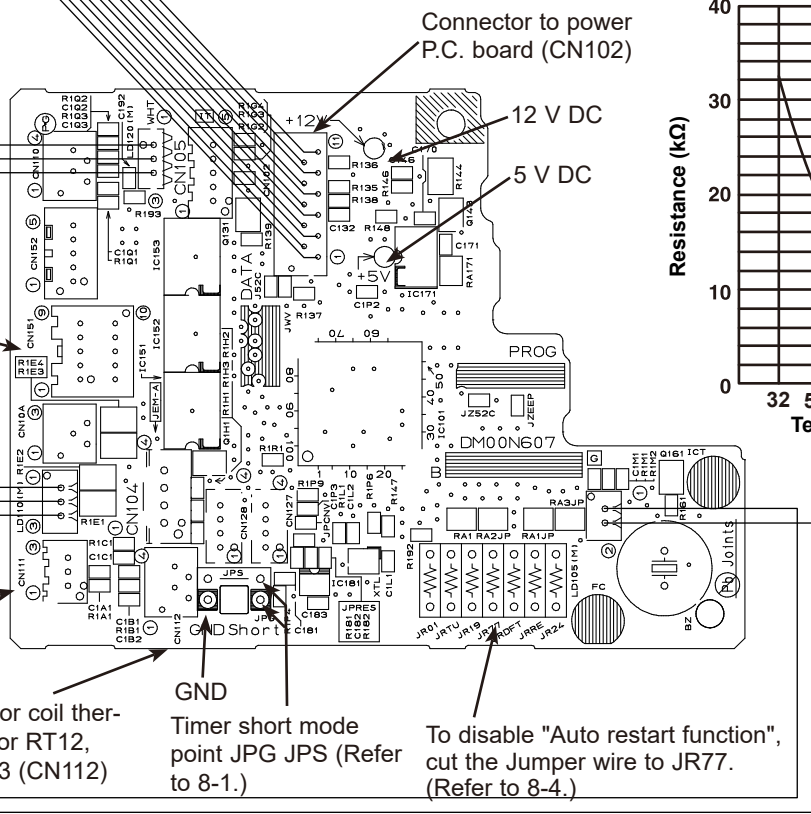
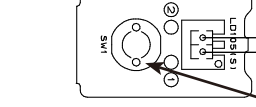

Room temperature thermistor (RT11)
Indoor coil thermistor (RT12, RT13)

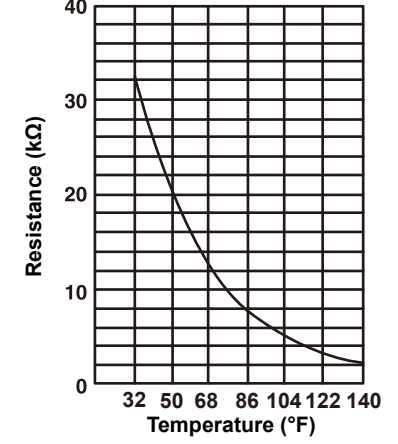

- Connector to power P.C. board (CN102)
- 12 V DC
- 5 V DC
- GND
- Timer short mode point JPG JPS (Refer to 8-1.)
- To disable "Auto restart function", cut the Jumper wire to JR77. (Refer to 8-4.)

<Dataching method of the terminal with locking mechanism>

The terminal which has the locking mechanism can be detached as shown below.
 There are 2 types of terminals with locking mechanisms.
 The terminal without locking mechanism can be detached by pulling it out.
 Check the shape of the terminal before detaching.

(1) Slide the sleeve and check if there is a locking lever or not.

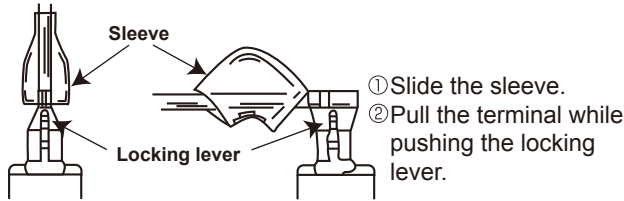

(2) The terminal with this connector shown below has the locking mechanism.

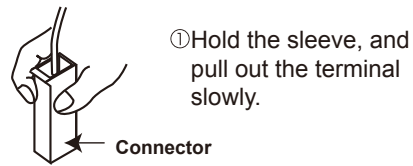

- | | | | |
|--------------------------|--------------------|--------------------|--------------------|
| 10-1. MSZ-EF09NAW | MSZ-EF12NAW | MSZ-EF15NAW | MSZ-EF18NAW |
| MSZ-EF09NAB | MSZ-EF12NAB | MSZ-EF15NAB | MSZ-EF18NAB |
| MSZ-EF09NAS | MSZ-EF12NAS | MSZ-EF15NAS | MSZ-EF18NAS |

NOTE: Turn OFF power supply before disassembly.

—————>: Indicates the visible parts in the photos/figures.
 - - - - ->: Indicates the invisible parts in the photos/figures.

OPERATING PROCEDURE	PHOTOS/FIGURES
<p>1. Removing the panel</p> <p>(1) Remove the horizontal vanes.</p> <p>(2) Remove the screw caps of the panel. Remove the screws of the panel.</p> <p>(3) Unhook the lower part (A) of the panel.</p> <p>(4) First, hold the lower part of the right end of the panel, and hold the lower part of the left end of the panel.</p> <p>(5) Pull the panel slightly toward you, and then remove the panel by pushing it upward.</p>	<p>Photo 1</p> <p>Photo: MSZ-EF-NAB</p>

OPERATING PROCEDURE

2. Remove the indoor electrical box

- (1) Remove the panel (Refer to section 1.) and the corner box right.
- (2) Remove the screw of the V.A. clamp. Remove the V.A. clamp and the indoor/outdoor connecting wire.
- (3) Remove the ground wire connected to the indoor heat exchanger from the electrical box.
- (4) Remove the screw of the electrical cover and remove the electrical cover.
- (5) Disconnect following connectors:
 - <Indoor electronic control P.C. board> CN151 (Vane motor)
 - <Indoor power P.C. board> CN211 (Indoor fan motor)
- (6) Remove the screw fixing the electrical box, then the upper catch of the electrical box, and pull out the electrical box.

3. Removing the indoor power P.C. board, the switch board, the display board, the receiver board and the indoor electronic control P.C. board

- (1) Remove the panel (Refer to section 1.) and the corner box right.
- (2) Remove the screw of the V.A. clamp. Remove the V.A. clamp and the indoor/outdoor connecting wire.
- (3) Remove the screw of the conduit cover and the conduit cover. (Photo 3)
- (4) Remove the screw of the conduit plate and the conduit plate. (Photo 4)
- (5) Remove the screw fixing the electrical box.
- (6) Remove the indoor electrical box (Refer to section 2.).
- (7) Remove the ground wire connected to the electrical box from the indoor power P.C. board.
- (8) Disconnect the following connectors:
 - <Indoor electronic power P.C. board> CN201 (Terminal block)
 - CN202 (To the indoor electronic control P.C. board)
- (9) Remove the indoor power P.C. board.
- (10) Disconnect the following connectors:
 - <Indoor electronic control P.C. board> CN111 (Room temperature thermistor)
 - CN112 (Indoor coil thermistor)
- (11) Unhook the catches of the display P.C. board holder from the nozzle and the electrical box (right side).
- (12) Open the rear cover of the display P.C. board holder and remove the switch board, the display board and the receiver board.
Remove the indoor electronic control P.C. board.

PHOTOS/FIGURES

Photo 2

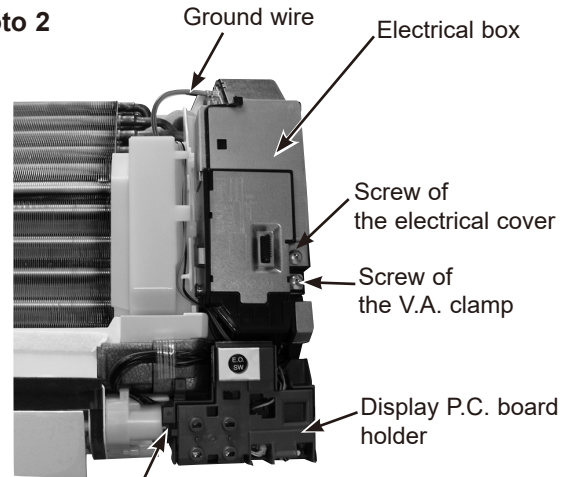

Catch of indoor electronic control P.C. board holder

Photo 3

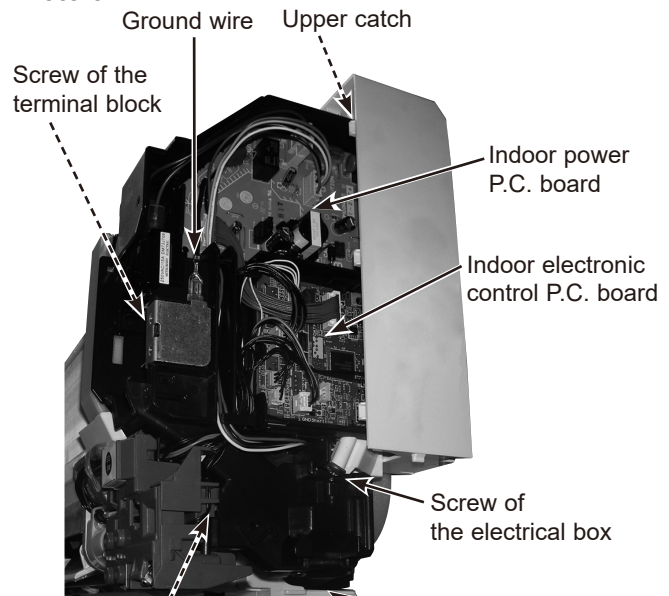

Catch of indoor electronic control P.C. board holder

Photo 4

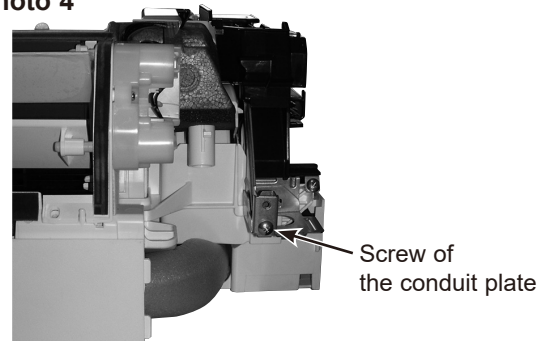

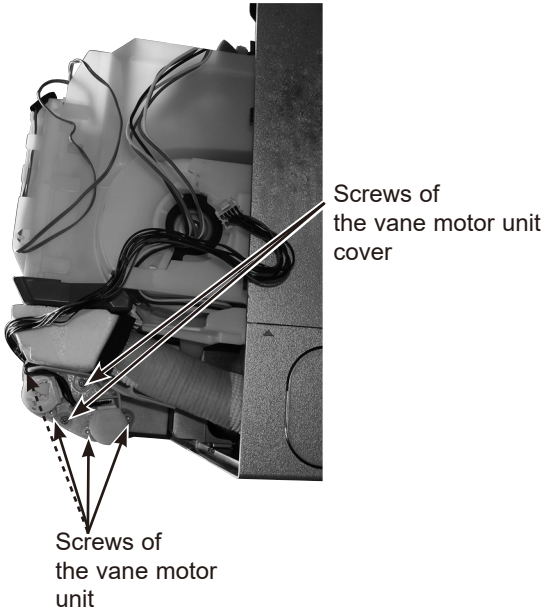

OPERATING PROCEDURE	PHOTOS/FIGURES
<p>4. Removing the nozzle assembly</p> <ul style="list-style-type: none">(1) Remove the panel (Refer to section 1.) and the corner box right.(2) Remove the indoor/outdoor connecting wire (Refer to 2.).(3) Remove the electrical cover (Refer to section 2.).(4) Disconnect the following connector: <Indoor electronic control P.C. board> CN151 (Vane motor)(5) Remove the display P.C. board holder.(6) Pull out the drain hose from the nozzle assembly and remove the nozzle assembly.(7) Remove the vane motors (Refer to section 5.).	<p>Photo 5</p>  <p>Screws of the vane motor unit cover</p> <p>Screws of the vane motor unit</p>
<p>5. Removing the horizontal vane motor</p> <ul style="list-style-type: none">(1) Remove the nozzle assembly (Refer to section 4.).(2) Remove the screws of the vane motor unit cover, and pull out the vane motor unit(3) Remove the screws of the vane motor unit.(4) Disconnect the connector from the vane motor.(5) Remove the vane motor from the vane motor unit.	

OPERATING PROCEDURE

6. Removing the indoor fan motor, the indoor coil thermistor and the line flow fan

- (1) Remove the panel (Refer to section 1.) and the corner box right.
- (2) Remove the indoor electronic control P.C. board holder, the electrical box and the nozzle assembly.
- (3) Remove the screws fixing the motor bed.
- (4) Release the hooks of the water cut and remove the water cut.
- (5) Loosen the screw fixing the line flow fan.
- (6) Remove the motor bed together with the indoor fan motor and the motor band.
- (7) Release the hooks of the motor band and remove the motor band. Pull out the indoor fan motor.
- (8) Remove the indoor coil thermistor from the heat exchanger.
 - * Install the indoor coil thermistor in its former position when assembling it (Photo 6.).
- (9) Remove the screws fixing the left side and the upper right side of the heat exchanger (Photo 8, Photo 9).
- (10) Lift the heat exchanger, and pull out the line flow fan to the lower-left.

* When attaching the line flow fan, screw the line flow fan so 4 mm gap is provided between the right end of the line flow fan and the right wall of the air passage of the box (Figure 1).

Figure 1

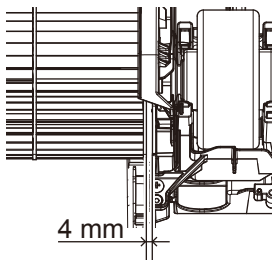

PHOTOS/FIGURES

Photo 6

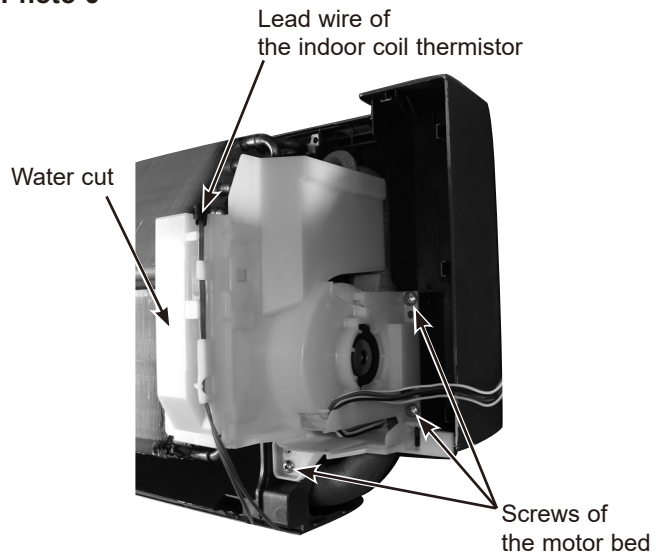

Photo 7

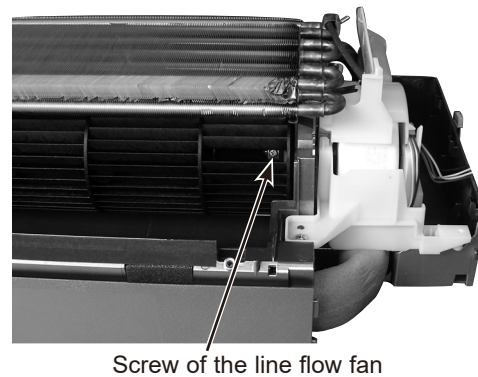

Photo 8

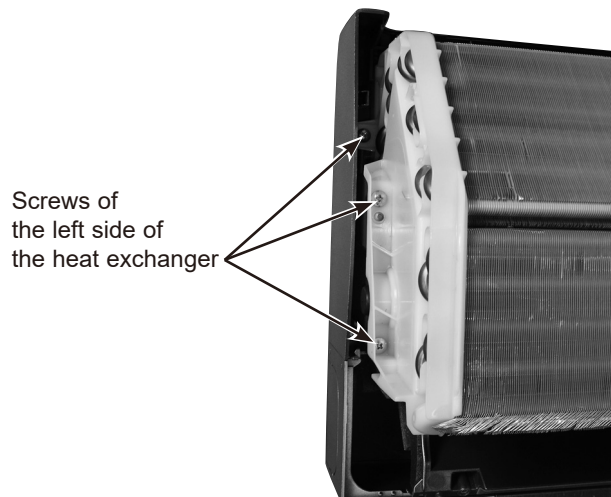
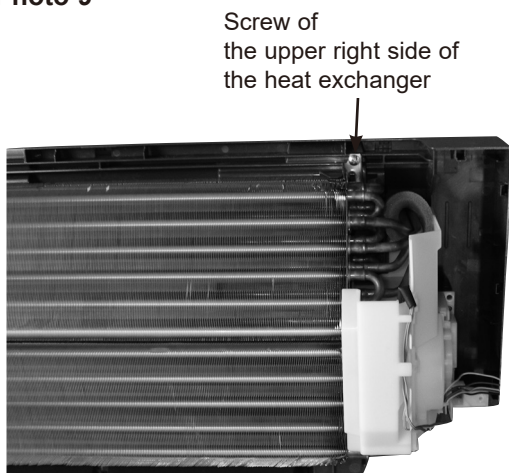

Photo 9



Fixing the indoor coil thermistor

*There are 2 forms of parts for fixing the indoor coil thermistor.

Clip shape



Holder shape



When fixing the indoor coil thermistor to the clip-shape/holder-shape part, the lead wire should point down.

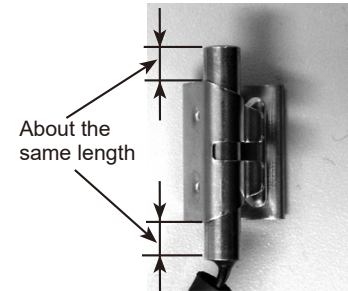

Position and procedure for mounting the clip-shape part

1. Set the indoor coil thermistor in the center of the clip-shape part.

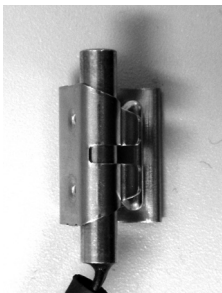

2. Check the (marked) mounting position.



3. Mount the clip-shape part.



NOTE:

- Take care to avoid loss and accidental falling of the clip-shape part inside the unit.
- Mount the clip-shape part on the marked position.
- Do not pull the lead wire when removing the indoor coil thermistor.

MITSUBISHI ELECTRIC CORPORATION

HEAD OFFICE: TOKYO BUILDING, 2-7-3, MARUNOUCHI, CHIYODA-KU, TOKYO 100-8310, JAPAN

© Copyright 2015 MITSUBISHI ELECTRIC CORPORATION

Issued: Feb. 2021. No. OBH736 REVISED EDITION-B

Issued: Oct. 2018. No. OBH736 REVISED EDITION-A

Published: Oct. 2015. No. OBH736

Made in Japan

Specifications are subject to change without notice.