

USER'S INFORMATION MANUAL

I-Series Condensing Boiler

Wall-Mounted, Gas-Fired Combi Boiler

Central Heating and Domestic Hot Water



COMBI MODELS

i060C (REB-A1847FF-US)
i090C (REB-A2647FF-US)
i120C (REB-A3558FF-US)

Certified to ANSI Z21.13
and CSA 4.9



WARNING If the information in these instructions are not followed exactly, a fire or explosion may result causing property damage, personal injury, or death.

- Do not store or use gasoline or other flammable vapors and liquids in the vicinity of this or any other appliance.
- WHAT TO DO IF YOU SMELL GAS
 - Do not try to light any appliance.
 - Do not touch any electrical switch; do not use any phone in your building.
 - Immediately call your gas supplier from a neighbor's phone. Follow the gas supplier's instructions.
 - If you cannot reach your gas supplier, call the fire department.
- Installation and service must be performed by a qualified installer, service agency or the gas supplier.



Contents

1. Safety	3
1.1 Safety Symbols	3
1.2 Safety Precautions	4
1.3 Gas Operating Instructions	6
2. About the Boiler	7
2.1 Front View	7
2.2 Bottom View	8
2.3 Control Panel	9
2.3.1 Control Panel Features	9
2.3.2 Display Window	10
2.3.3 Pressure and Temperature Display	11
3. Operating the Boiler	12
3.1 Turning the Boiler On or Off	12
3.2 Change Units of Measurement	13
3.3 Change Control Panel Sounds	13
3.4 Change Child Lock Function	14
3.5 Adjust the DHW Temperature	15
3.5.1 Sequence of Operation for DHW Temperature	17
3.5.2 Setting DHW Comfort Modes	18
3.6 Adjust the Central Heating Temperature	19
3.6.1 Sequence of Operation for Central Heating Temperature	21
4. Troubleshooting	23
4.1 Troubleshooting	23
4.2 Diagnostic Codes	25
4.2.1 Reset Diagnostic Codes	26
5. Maintenance	27
5.1 Owner Maintenance Schedule	27
5.2 Freeze Protection	28
6. Notes	29

Welcome

Thank you for choosing a Rinnai Condensing Boiler. Before using the boiler, please read this manual completely and retain it for future reference.

As when using any appliance generating heat, there are certain safety precautions you should follow. See the “Safety Precautions” section in this manual for detailed safety precautions.

For the “Rinnai I-Series Condensing Boiler Installation and Operation Manual,” please visit rinnai.us.

Acronyms and Abbreviations

Following is a list of common acronyms and abbreviations used in this manual:

ANSI	American National Standards Institute
CH	Central Heating
Combi	Combination of Central Heating and Domestic Hot Water
DHW	Domestic Hot Water
LWCO	Low Water Cut Off
NG	Natural Gas
PP	Polypropylene
PRV	Pressure Relief Valve
PSI	Pounds per square inch

For Your Records

Dealer Name: _____

Dealer Phone #: _____

Purchase Date: _____

Serial #: _____

Located on the left side of unit

1 Safety

WARNING

- If the information in these instructions is not followed exactly, a fire or explosion may result causing property damage, personal injury, or death.
- Do not store or use gasoline or other flammable vapors and liquids in the vicinity of this or any other appliance.
- WHAT TO DO IF YOU SMELL GAS:
 - Do not try to light any appliance.
 - Do not touch any electrical switch; do not use any phone in your building.
 - Immediately call your gas supplier from a neighbor's phone. Follow the gas supplier's instructions.
 - If you cannot reach your gas supplier, call the fire department.
- Installation and service must be performed by a qualified installer, service agency or the gas supplier.
- The warning signs in this manual are here to prevent injury to you and others. Please follow them explicitly.

1.1 Safety Symbols

This manual contains the following important safety symbols. Always read and obey all safety messages.



Safety alert symbol. Alerts you to potential hazards that can kill or hurt you and others.

DANGER

Indicates an imminently hazardous situation which, if not avoided, will result in personal injury or death.

WARNING

Indicates a potentially hazardous situation which, if not avoided, could result in personal injury or death.

CAUTION

Indicates a potentially hazardous situation which, if not avoided, could result in minor or moderate injury. It may also be used to alert against unsafe practices.

1.2 Safety Precautions

Please read and follow the safety precautions listed below.

DANGER

Should overheating occur or the gas supply fail to shut off, do not turn off or disconnect the electrical supply to the pump. Instead, shut off the gas supply at a location external to the appliance.

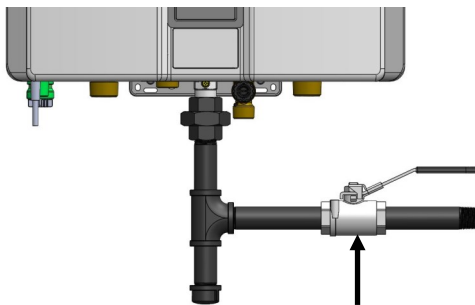

Gas shut off valve

WARNING

Inspecting the Exhaust and Intake Venting System:

- Visually inspect the entire exhaust vent and intake system. Look closely for blockages, deterioration, leaks or any other type of damage to the system. Repair any joints that show signs of leakage. Make sure the intake vent pipe is connected and properly sealed (if applicable).
- Examine the exhaust vent and air intake to make sure they are clean and free of obstructions.

WARNING

Environment: Air surrounding the boiler, venting, and vent termination(s) is used for combustion and must be free of any compounds that cause corrosion of internal components. These include corrosive compounds that are found in aerosol sprays, detergents, bleaches, cleaning solvents, oil based paints/ varnishes, and refrigerants. The air in beauty shops, dry cleaning stores, photo processing labs, and storage areas for pool supplies often contains these compounds. In applications utilizing room air where there are high levels of particulates, Rinnai offers a room air screen. The boiler, venting, and vent termination(s) should not be installed in any areas where the air may contain these corrosive compounds.

California law requires the following Proposition 65 warning to be provided:

WARNING

This product can expose you to chemicals including lead, lead compounds and carbon disulfide which are known to the State of California to cause cancer, birth defects or other reproductive harm. For more information, visit www.P65Warnings.ca.gov.

WARNING

- Check the water pressure in the central heating installation regularly. See the “Rinnai I-Series Condensing Boiler Installation and Operation Manual” for specific glycols, inhibitors, and system cleaners permitted. Contact your installer in case of doubt.
- Do not use this boiler if any part has been under water. Immediately call a qualified service technician to inspect the boiler and to replace any part of the control system and any gas control which has been under water.
- Flammable liquids such as cleaning solvents, aerosols, paint thinners, adhesives, gasoline and propane must be handled and stored with extreme care. These flammable liquids emit flammable vapors and when exposed to an ignition source can result in a fire hazard or explosion. Flammable liquids should not be used or stored in the vicinity of this or any other gas appliance.
- Do not obstruct combustion air to the boiler.
- Do not use an extension cord or adapter plug with this appliance.
- Any alteration to the appliance or its controls can be dangerous and will void the warranty.

WARNING

- DO NOT operate the boiler without the front panel installed. The front panel should only be removed for service/maintenance or replacing internal components.
- BURN HAZARD. Hot exhaust and vent may cause serious burns. Keep away from the boiler. Keep small children and animals away from the boiler.
- Heating supply, heating return, and domestic hot water outlet pipes leaving the boiler can be hot to touch.
- Rinnai recommends that every home have a carbon monoxide (CO) alarm in the hallway near bedrooms in each sleeping area. Check batteries monthly and replace them annually.
- Always check the water temperature before entering a shower or bath.



1.3 Gas Operating Instructions

FOR YOUR SAFETY READ BEFORE OPERATING

WARNING: If you do not follow these instructions EXACTLY, a fire or explosion may result causing property damage, personal injury or loss of life.

- A. This appliance does not have a pilot. It is equipped with an ignition device which automatically lights the burner. Do not try to light the burner by hand.
- B. BEFORE OPERATING smell all around the appliance area for gas. Be sure to smell next to the floor because some gas is heavier than air and will settle on the floor.
WHAT TO DO IF YOU SMELL GAS:
 - DO NOT try to light any appliance.
 - DO NOT touch any electric switch; DO NOT use any phone in your building.
 - Immediately call your gas supplier from a neighbor's phone. Follow the gas supplier's instructions.
 - If you cannot reach your gas supplier, call the fire department.
- C. Use only your hand to turn the gas control valve. Never use tools. If the gas control valve will not turn by hand, don't try to repair it, call a qualified service technician. Force or attempted repair may result in a fire or explosion.
- D. Do not use this appliance if any part has been under water. Immediately call a qualified service technician to inspect the appliance and to replace any part of the control system and any gas control which has been under water.

OPERATING INSTRUCTIONS

1. STOP! Read the safety information above on this label.
2. Set the temperature controller to lowest setting.
3. Turn off all electric power to the appliance.
4. This appliance does not have a pilot. It is equipped with a direct ignition device which automatically lights the burner. DO NOT try to light the burner by hand.
5. Turn the manual gas control valve located at gas inlet of appliance clockwise  to the OFF position.
6. Wait five (5) minutes to clear out any gas. Then smell for gas, including near the floor. If you smell gas, STOP! Follow "B" in the safety information above on this label. If you don't smell gas, go to the next step.
7. Turn the manual gas control valve located at gas inlet of appliance counterclockwise  to the ON position.
8. Turn on all electric power to the appliance.
9. Set the temperature controller to desired setting.
10. If the appliance will not operate, follow the instructions "To Turn Off Gas To Appliance" and call your service technician or gas supplier.

TO TURN OFF GAS TO APPLIANCE

1. Set the temperature controller to the lowest setting.
2. Turn off all electric power to the appliance if service is to be performed.
3. Turn the manual gas control valve located at gas inlet of appliance clockwise  to the OFF position.

2

About the Boiler

The I-Series Condensing Boiler is a wall-mounted, gas-fired boiler designed to providing heating and domestic hot water.

For complete boiler information, refer to the “Rinnai I-Series Condensing Boiler Installation Manual” supplied with the boiler, or visit rinnai.us.

2.1 Front View

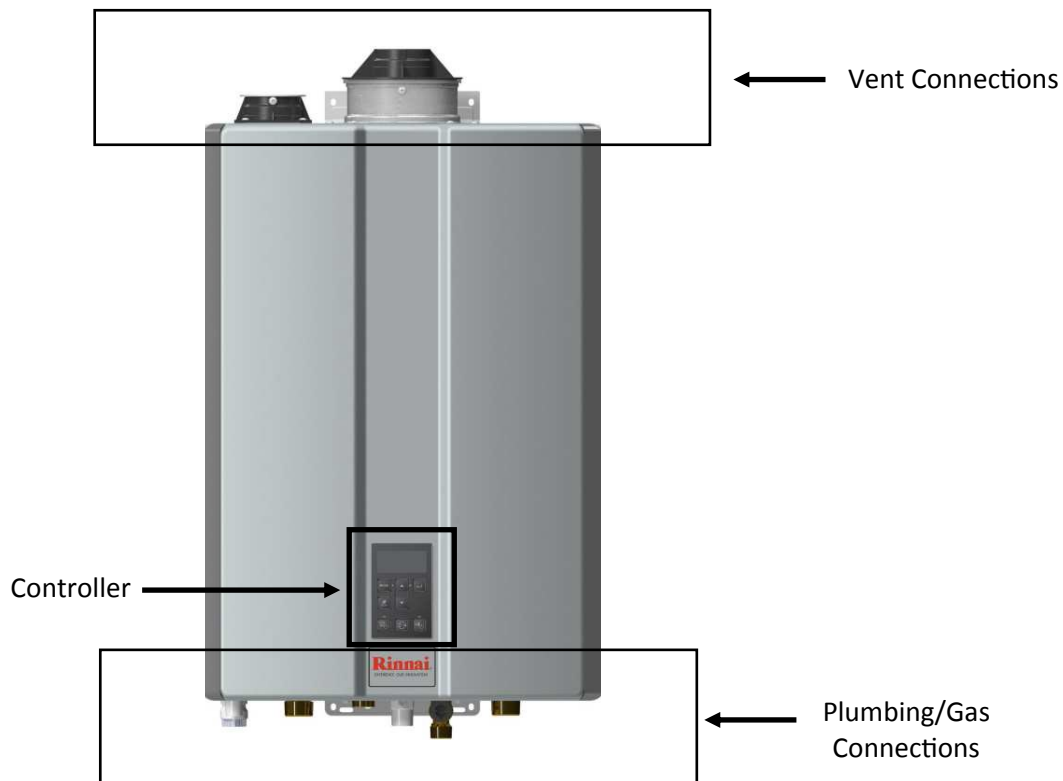

2.2 Bottom View

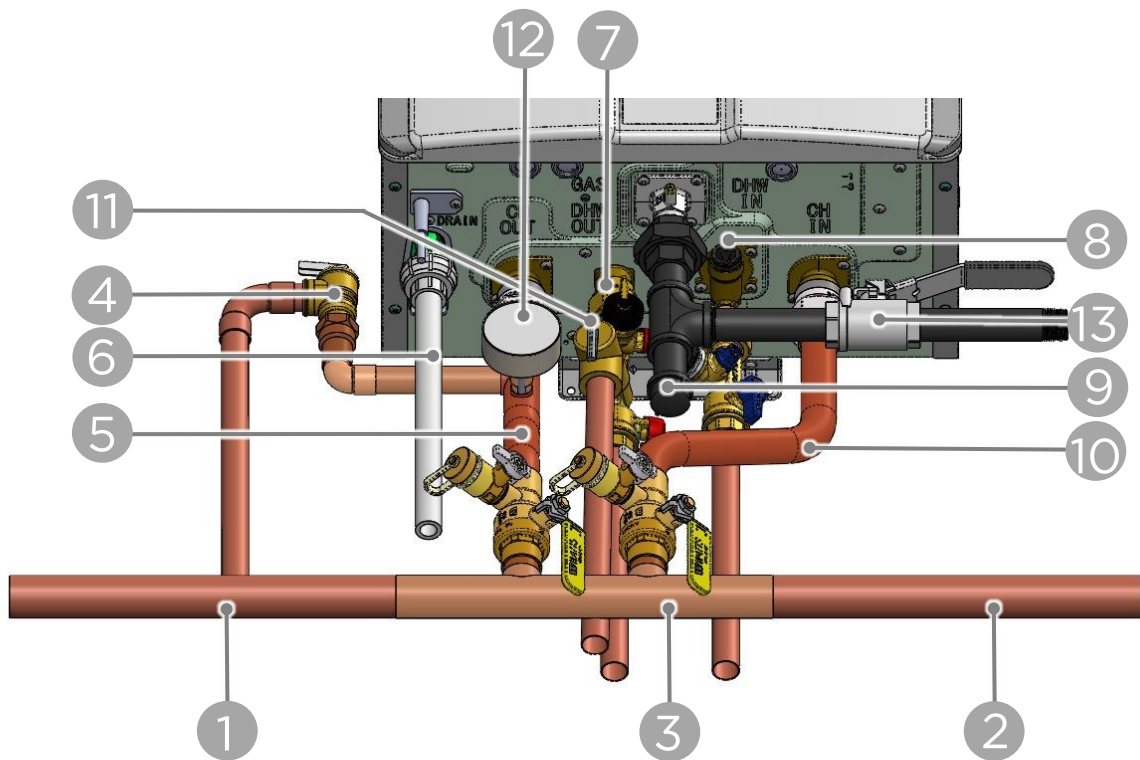

All items are field-supplied unless otherwise noted.

- | | | | |
|----|--|-----|--|
| 1. | Supply to Central Heating System | 8. | Domestic Cold Water |
| 2. | Return from Central Heating System | 9. | Gas |
| 3. | Primary-Secondary Heating Kit | 10. | Central Heating Return |
| 4. | Central Heating Pressure Relief Valve (supplied with boiler) | 11. | Domestic Hot Water Pressure Relief Valve |
| 5. | Central Heating Supply | 12. | Central Heating Pressure Gauge |
| 6. | Condensate Drain | 13. | Gas Shut Off Valve |
| 7. | Domestic Hot Water | | |

2.3 Control Panel

2.3.1 Control Panel Features

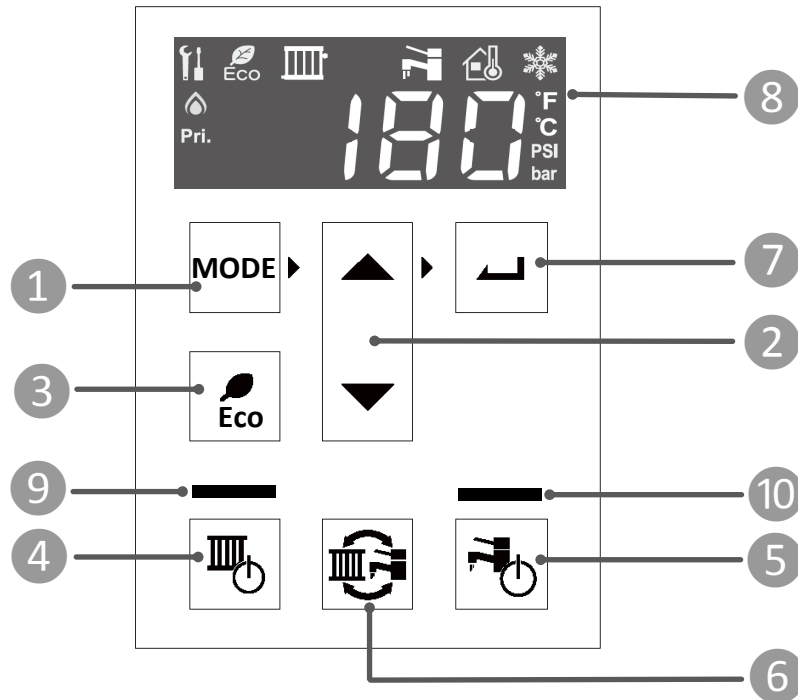

- 1 MODE**
Selects various boiler settings.
- 2 Up/Down Arrows**
Scrolls through available menu options including adjusting the temperature.
- 3 Eco**
Selects Eco or Comfort operation mode.
- 4 Central Heating (CH)**
From the factory, this option is turned off by default. The boiler runs off thermostat inputs on the control board. For any adjustments, contact a trained and qualified professional for setting assistance. Adjustments must be made by a trained and qualified professional for this mode to operate correctly.
- 5 Domestic Hot Water On**
Press to run the boiler in Domestic Hot Water mode.
- 6 Switching Operation Mode**
Press to change the display between DHW and CH for temperature setting.
- 7 Select Button**
Press to select the option in the display window.
- 8 Display Window**
Displays boiler status information.
*See **Display Window** section for more information.*
- 9 CH Button LED**
When the LED light above the **CH** button is illuminated, CH mode is active.
- 10 DHW Button LED**
When the LED light above the **DHW** button is illuminated, DHW mode is active.

2.3.2 Display Window

When the boiler is turned on, the main screen (also called the home screen) appears in the display.

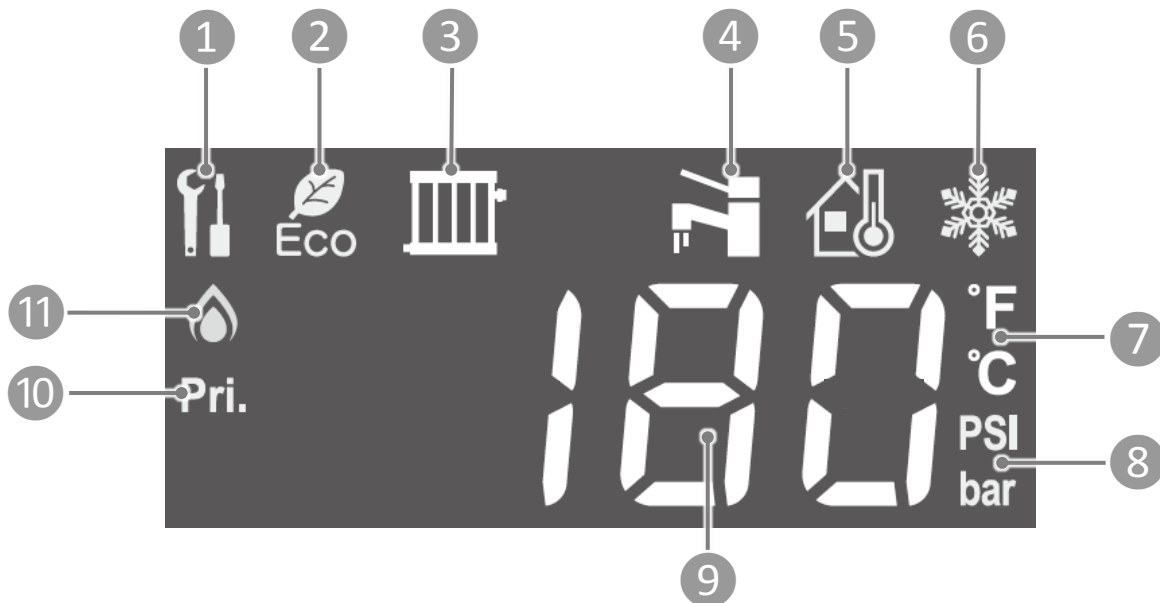

1 Maintenance Mode Icon

Appears when the boiler is in Parameter Settings Mode, Deaeration Mode, Performance Data Mode, Error History Mode, etc.

2 Eco Setting Active

Eco maintains temperature in the primary heat exchanger to provide quicker delivery of hot water to fixtures.

3 Central Heating Mode Active

4 Domestic Hot Water Mode Active

5 Outdoor Thermostat Connected

6 Freeze Protection Active

7 Unit of Measurement for Temperature

8 Unit of Measurement for Pressure

Note: Pressure and temperature are alternately displayed on the controller.

9 Setpoint Temperature, Current Temperature or Current Pressure

Note: Pressure and temperature are alternately displayed on the controller.

10 Priority Control

11 "In Use" Light (boiler has fired and is running)

2.3.3 Pressure and Temperature Display

The boiler will display the current pressure or temperature as shown below.

Standby

If the boiler is in standby and the **CH ON** and **DHW ON** buttons are not illuminated, the current system pressure will display.

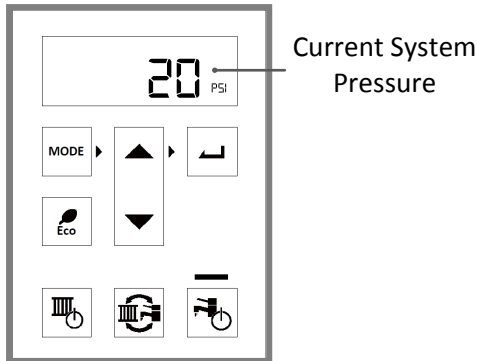

Domestic Hot Water Operation

When the boiler is in DHW operation and DHW standby (**DHW** icon is displayed), the current system pressure and the DHW set point temperature will alternately display.

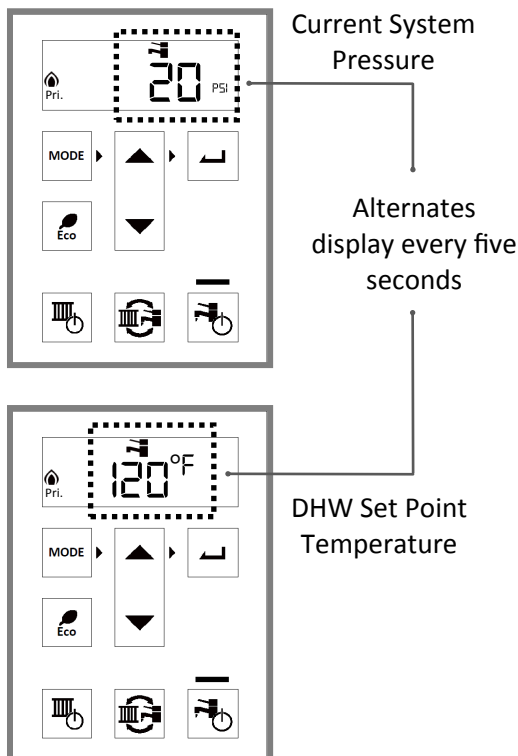

Central Heating Operation

When the boiler is in CH operation and CH standby (**CH** icon is displayed), the current pressure and the CH supply temperature will alternately display.

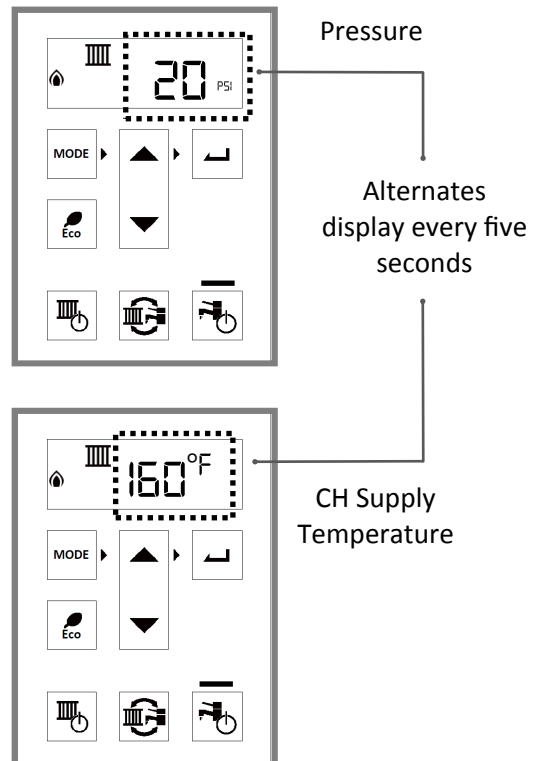

- If a warning diagnostic code appears, the code will cycle quicker between the current pressure, temperature, and the diagnostic code.
- If an error diagnostic code appears, only the code will display.

3

Operating the Boiler

This section includes instructions for starting and operating the boiler.

⚠ WARNING

Do not use an extension cord or adapter plug with this appliance.

3.1 Turn the Boiler On or Off

Connect power to the boiler by plugging it into a power outlet. The controller will light up and is now ready to be set for DHW and/or CH.

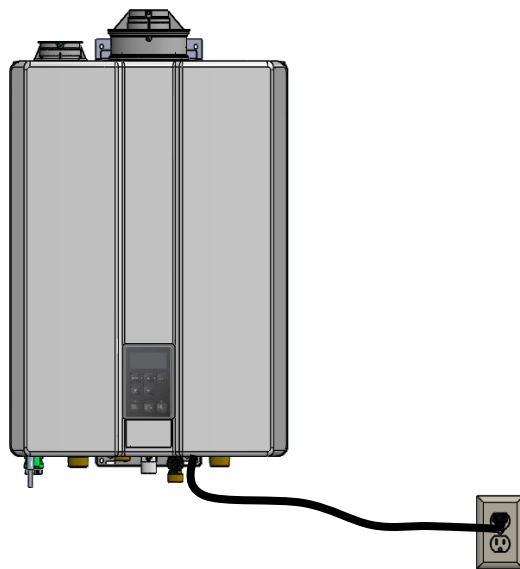

3.2 Change Units of Measurement

To change the units of measurement appearing on the boiler display, follow the steps below.

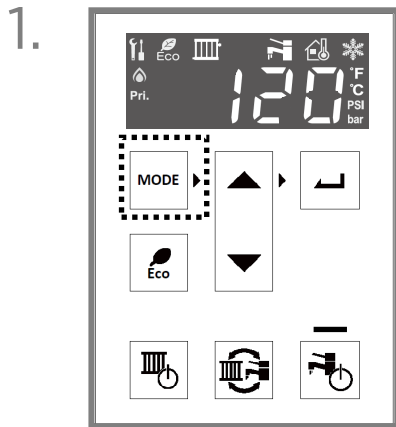

Press the **Mode** button.

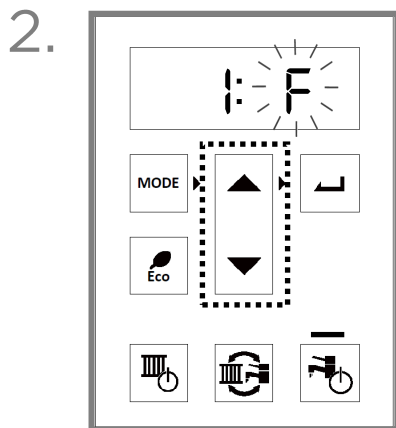

Press the **Up** or **Down** arrows to select a unit.

- F = U.S. Measurements (°F/PSI)
- C = Metric (°C/bar)

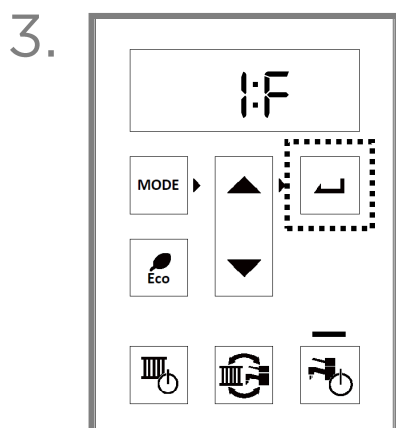

Press the **Select** button.

3.3 Change Control Panel Sounds

To turn the control panel click sound on or off, follow the steps below.

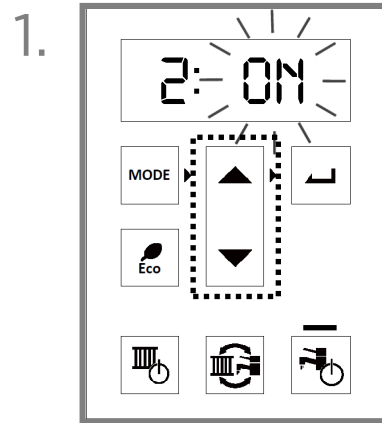

Press the **Mode** button twice. **2:ON** should appear on the display. Press the **Up** or **Down** arrows to select ON or OFF.

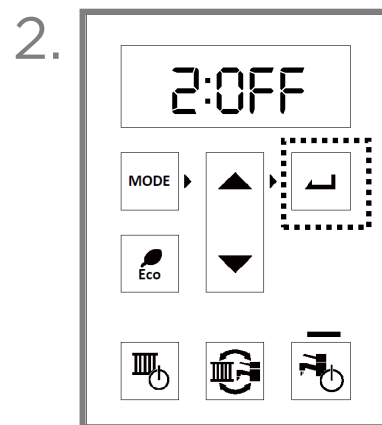

Press the **Select** button.

3.4 Change Child Lock Function

To turn the child lock function on or off, follow the steps below.

NOTE

- When Child Lock is enabled, the only function available is to turn off Central Heating (by pressing the **Central Heating** button on the controller); this occurs only if DIP switch 2 is set to the ON position. See the “DIP Switches” section in the “Rinnai I-Series Condensing Boiler Installation and Operation Manual” for more information.
- When there are multiple controllers installed on the same boiler, you can only lock the controller that has priority.
- If a button is pressed when the Child Lock function is engaged, “LOC” will be displayed on the controller.

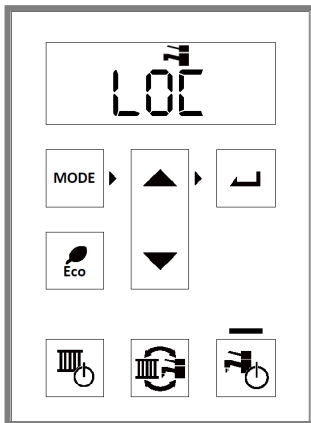

1.

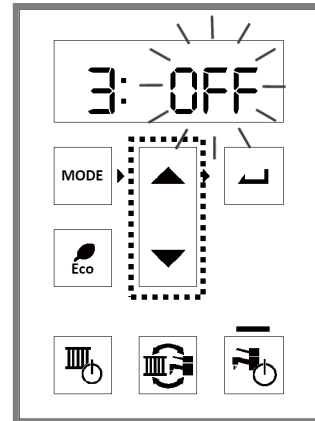

Press the **Mode** button three times. **3:OFF** should appear on the display. Press the **Up** or **Down** arrows to select:

- OFF - Child Lock OFF
- LOC - Child Lock ON

2.

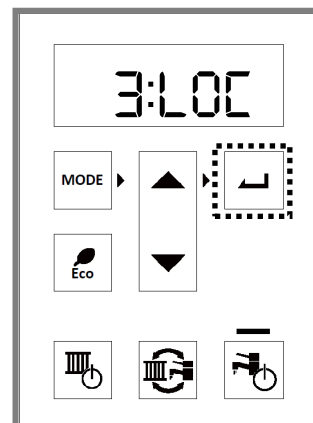

Press the **Select** button.

3.5 Adjust the DHW Temperature

To adjust the DHW setpoint temperature, follow the steps below.

1.

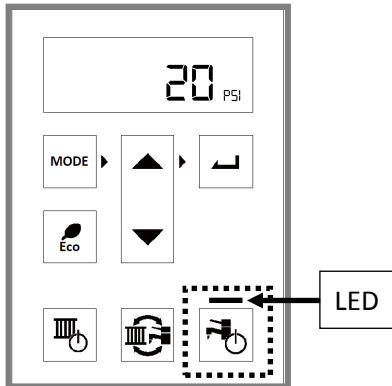

If the LED above the **DHW** button is not illuminated, press the **DHW** button.

If the LED above the **DHW** button is illuminated, proceed to Step 2.

2.

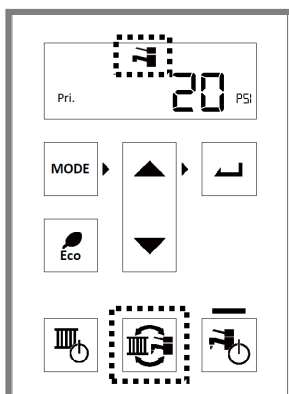

Press the **Switch Operation Mode** button until the **DHW Active** icon appears on the home screen.

3.

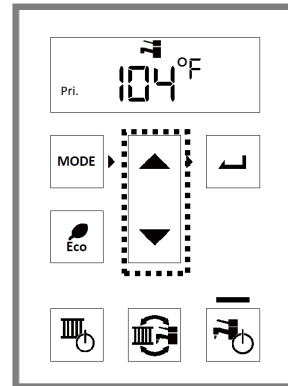

Adjust the temperature with the **UP** and **DOWN** arrows until the appropriate temperature is displayed.

4.

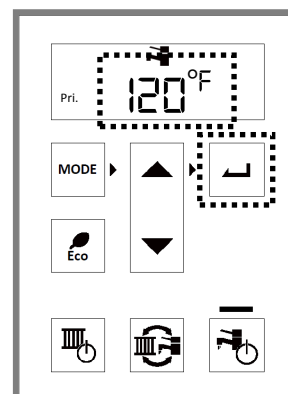

Press the **Select** button to confirm the temperature.

This temperature setting is displayed for a few seconds and then returns to standby mode.

The available DHW set point temperatures are provided below. When the unit of measurement changes (°C/°F), the corresponding temperature in the table changes.

Factory Default: 104°F (40°C)

The factory default maximum temperature is limited to 120°F. To select temperatures above 120°F (49°C), the DHW Maximum Setpoint Temperature will need to be adjusted. Please refer to the “Rinnai I-Series Condensing Boiler Installation and Operation Manual” for further details.

Temperature Settings	
Fahrenheit (°F)	Celsius (°C)
98	37
100	38
102	39
104	40
106	41
108	42
110	43
112	44
114	45
116	46
118	47
120	48
125	49
130	50
135	52
140	54
	56
	58
	60

This boiler requires a minimum flow rate of 0.4 GPM to operate. In some cases when you are not getting hot water or if the water alternates between hot and cold, it is due to the water flow being below or close to the minimum flow rate. Increasing the flow rate should resolve these problems.

If you are experiencing fluctuating water temperatures at a fixture, this may be due to a high temperature setting on your boiler (130°F-140°F). Decreasing the setpoint temperature may alleviate the fluctuations and deliver a stable temperature.

! DANGER

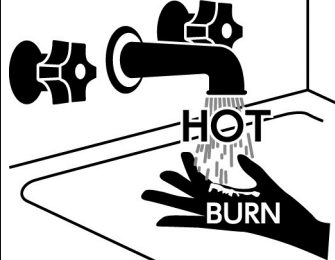

Water temperatures over 125°F (52° C) can cause severe burns or scalding resulting in death.

Hot water can cause first degree burns with exposure for as little as:

- 3 seconds at 140°F (60°C)
- 20 seconds at 130°F (54°C)
- 8 minutes at 120°F (49°C)

Children, disabled, or elderly are at highest risk of being scalded.

Feel water before bathing or showering.

IMPORTANT

- While any hot water is being provided, the temperature setting can only be adjusted between 98°F and 110°F. (37°C and 43°C)
- Check local codes for the maximum water temperature setting allowed when used in nursing homes, schools, day care centers, and all other public applications.
- If a newly installed boiler with a controller has not been powered for at least six hours, the temperature will return to the default setting of 104°F (40°C).
- There may be a variation between the temperature displayed on the temperature controller and the temperature at the tap due to weather conditions or the length of pipe to the boiler.

3.5.1 Sequence of Operation for DHW Temperature

1.

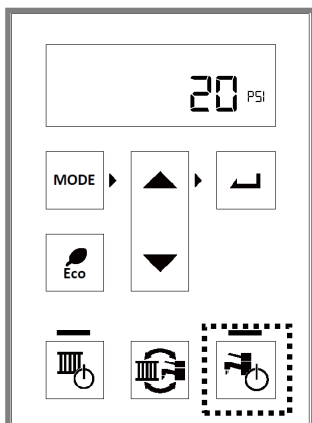

Press the **DHW** button

2.

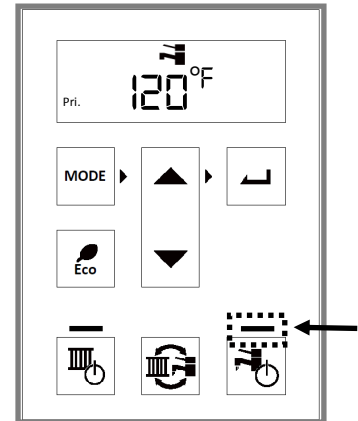

Confirm the DHW LED light is illuminated.

3.

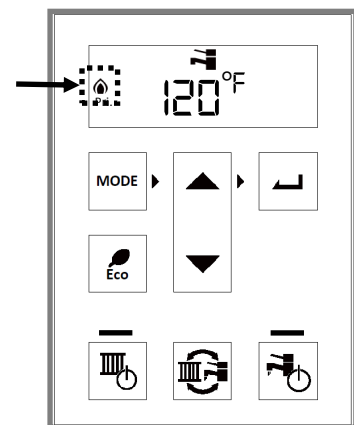

When a hot water fixture is in use and the boiler fires up, the "IN USE" light will be displayed.

3.5.2 Setting DHW Comfort Modes

Domestic Hot Water Comfort Modes are settings that would either supply quicker delivery of hot water to fixtures or save energy in the boiler operation.

By default, Eco mode is enabled (turned on). To enable (turn on) comfort mode, press the **Eco** button on the controller.

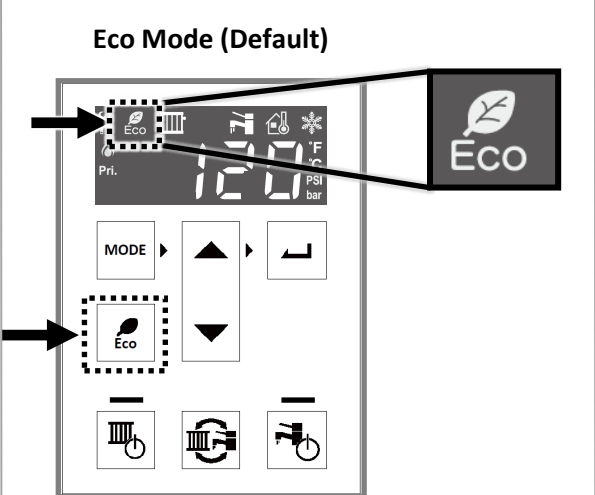
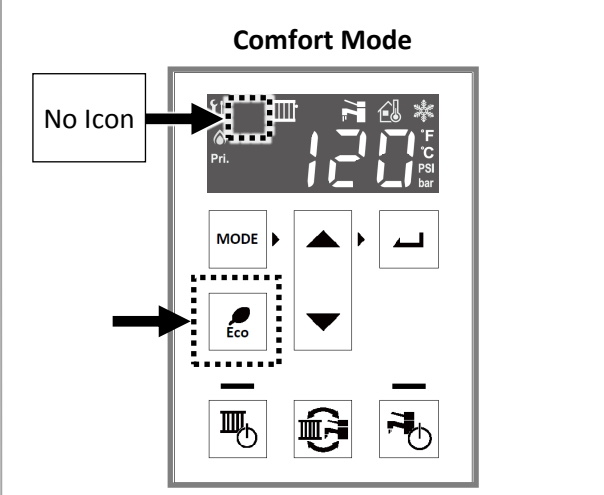
Eco Mode (Default)	Comfort Mode
<p>The boiler operates and produces hot water; however, it will not maintain the primary heat exchanger temperature for quicker hot water production. This selection saves some energy, but requires a longer time to provide hot water to the hot water fixtures.</p> 	<p>The boiler maintains the primary heat exchanger temperature to quickly deliver hot water to the plate heat exchanger. This selection provides the quickest delivery of hot water to hot water fixtures, but uses more energy.</p> 
<p>The Eco icon will illuminate when Eco Mode is active.</p> <p>NOTE During DHW recirculation, the Eco icon will always be on.</p>	<p>The Eco icon will not illuminate when Comfort Mode is active.</p>

3.6 Adjust the Central Heating Temperature

To adjust the CH setpoint temperature, follow the steps below.

IMPORTANT

When outdoor reset control activates, the target supply temperature for the CH system will not follow the CH setting temperature.

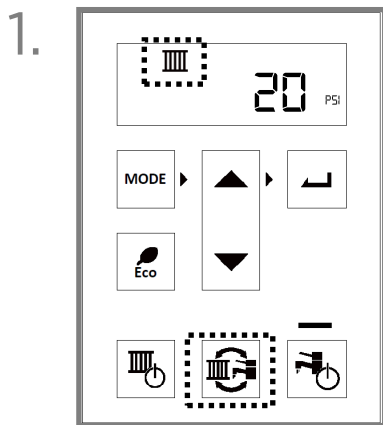

Press the **Switch Operation Mode** button until the **Central Heating Active** button appears on the home screen.

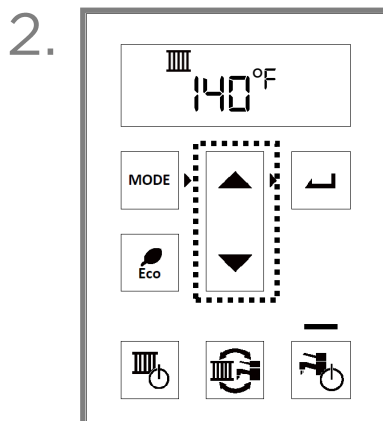

Adjust the temperature with the **Up** or **Down** arrows until the appropriate temperature is displayed.

3.

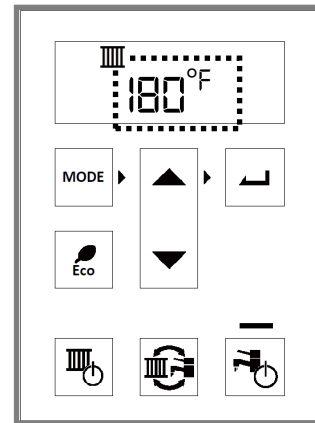

When the temperature flashes on the screen, the CH temperature setting has been set and is the active temperature.

This temperature setting is displayed for a few seconds and then returns to standby mode.

⚠ WARNING

Only adjust the target setpoint temperature of the system by consulting with the installer of the system or other qualified professional. If the target setpoint temperature is adjusted too high for the heat emitters in use, property damage may occur.

The CH target setpoint temperature can be set in 2°F (1°C) increments between 104°F-180°F (40°C-82°C).

Factory Default: 140°F (60°C)

Below are some typical target setpoint temperatures for various heat emitters. These are basic guidelines; thus, check with the emitter manufacturer or consult your heating design engineer.

Target Setpoint Temperatures		
Type of Heat Emitter	Typical Minimum Supply Temperature	Typical Maximum Supply Temperature
Hydronic Air Handler	120 - 140°F (49 - 60°C)	140 - 180°F (60 - 82°C)
Unit Heater	130 - 140°F (54 - 60°C)	160 - 180°F (71 - 82°C)
Base Board Convectors	100* - 140°F (38 - 60°C)	140 - 180°F (60 - 82°C)
Cast Iron/ Panel Radiator	90* - 120°F (32 - 49°C)	140 - 180°F (60 - 82°C)
Undermount Radiant	100* - 120°F (38 - 49°C)	120 - 150°F (49 - 66°C)

*Other hydronic components may be necessary to achieve minimum supply temperatures.

3.6.1 Sequence of Operation for Central Heating Temperature

The boiler can operate in either of two settings:

- A room thermostat
- The **CH** button being activated

Below is the sequence of operations for starting central heating via the room thermostat:

1.

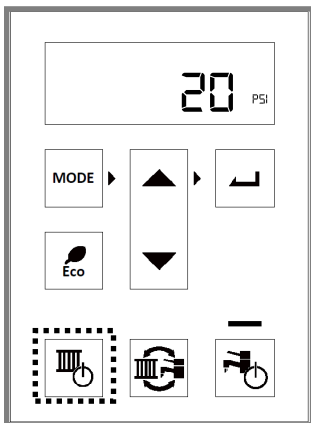

In room thermostat mode, the **CH** button does not affect heating operation. Operation is only possible with a call for heat from the room thermostat.

2.

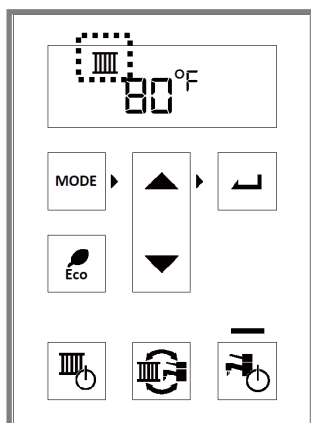

When a call for heat comes from the thermostat, the heating operation starts and the **CH Active** icon is illuminated.

3.

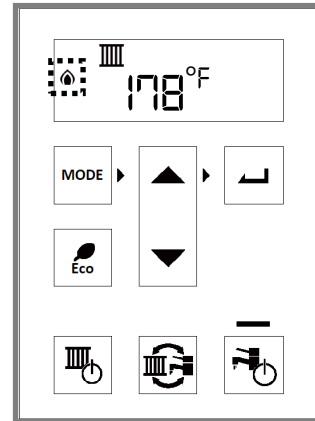

When the boiler ignites, the **In Use** icon is illuminated.

4.

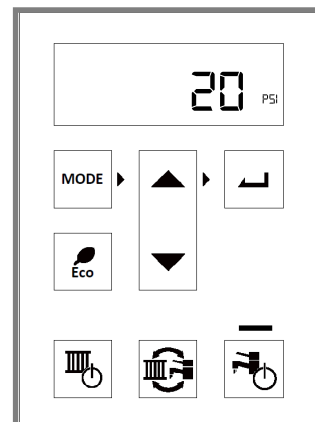

When the call for heat from the thermostat ends, the heating operation will turn off and the **CH Active** icon will no longer be illuminated.

NOTE

The **CH** icon will continue to be displayed for 24 hours beyond the last call for heat from the thermostat.

If the boiler installer selected to begin central heating by pressing the **CH** button, below are the sequence of operations appearing on the controller:

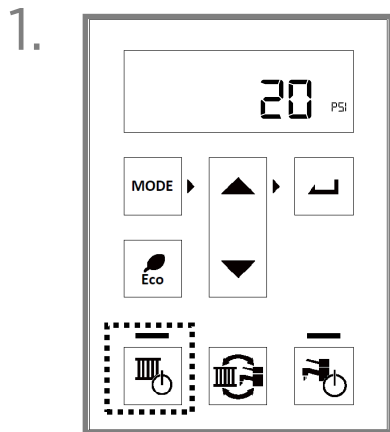

Press the **CH** button to begin operating the CH system.

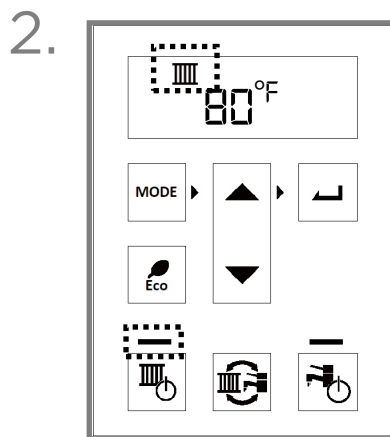

The **CH Active** icon is displayed and the LED above the **CH** button is illuminated.

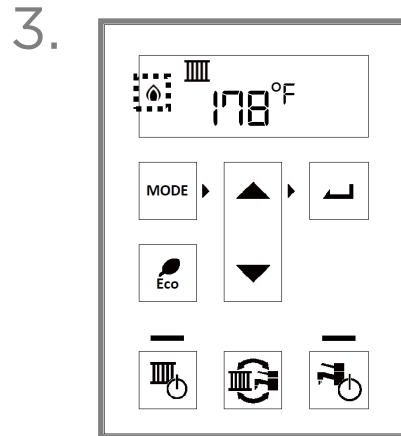

When the boiler ignites, the **In Use** icon is illuminated.

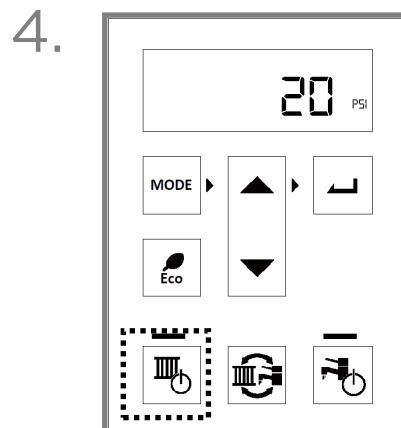

Press the **CH** button again to stop CH operation. The boiler will cycle ON/OFF based on the temperature water the boiler observes.

When the heating stops, the LED above the **CH** button and the **CH Active** icon will no longer be illuminated.

NOTE

This operation is only available when the **CH** button is selected. See the "Rinnai I-Series Condensing Boiler Installation and Operation Manual" for further details.

4

Troubleshooting

WARNING

Consumers should never attempt any action that they are not qualified to perform.

4.1 Troubleshooting

If you believe the boiler is not operating as designed, check possible reasons from the list below.

If an Error Diagnostic Code appears, contact a local Service Provider.

DHW	Hot water is not available.	Check that the gas is turned on at the boiler, gas meter, or cylinder.
		When using propane gas, is there sufficient gas available?
		Is the water supply valve off or disconnected?
		Is the faucet opened sufficiently?
		Is the DHW inlet filter clean?
		Is the boiler or other system piping frozen?
		Is the DHW switch On?
	The DHW temperature and pressure are fluctuating.	If the water flow volume is very small, the boiler will not activate. Turn on the faucet fully to allow for a greater flow demand.
		Is there sufficient water pressure?
		Is the setpoint temperature of DHW adequate?
		When the boiler is running in DHW and CH operation, the DHW temperature may fluctuate.
		When there is a long, uninsulated piping length between the boiler and fixture, the hot water temperature fluctuates. Ask the dealer to add insulation on the piping or increase the setpoint temperature.
	The boiler ceases to fire during a DHW demand.	Check that the gas is turned on at the boiler, gas meter, or cylinder.
		When using propane gas, is there sufficient gas available?
		If the water flow volume is very small, the boiler will not activate. Open a faucet more to allow for a greater flow demand.
		Reset the boiler by closing and opening the faucet again.
	The amount of hot water is fluctuating.	When DHW is used in multiple faucets at same time, the amount of hot water may be restricted.
		DHW may be restricted. The water supply pressure or system piping may affect the hot water volume.
	After the power is out or the power plug is pulled out, the setpoint temperature has changed.	The setpoint temperature may change after the boiler has had power restored. The setpoint temperature must be entered again.

Central Heating	The room temperature is not getting warm.	Is the target setpoint temperature of central heating appropriate for your application? (Refer to the “Target Setpoint Temperatures” table in section 3.6 of this manual.)
		When an outdoor sensor control is used, the supply temperature for central heating will vary depending on the outdoor temperature. To change the setting, contact your dealer.
		When using DHW with priority setting ON, central heating may be in standby. To change the setting of the simultaneous heating and DHW operation, contact your dealer.
		Check that the gas is turned on at the boiler, gas meter, or cylinder.
		When using propane gas, is there sufficient gas available?
Controller	The CH button does not work.	If the boiler is set up for CH via a room thermostat, the CH button will not work to operate the boiler.
	The setting temperature of DHW cannot be set higher than 120°F (49°C).	The maximum temperature setting may be selected at 120°F (49°C). To change the setting, contact your dealer.
	Cannot change the DHW set point temperature	While DHW is being provided, the temperature can only be adjusted between 98°F and 110°F. (37°C and 43°C)
Others	The sound of a pump occurs when neither CH or DHW are in use.	When the outdoor temperature is low, the freeze prevention operation may start with pump operation.
		When the boiler is not activated, the pump may operate for preventing locking up. The pump is operating to enable quicker output of DHW from the boiler.
	The boiler does not begin operation after power has been restored.	When power has been restored after a power outage or the power plug is disengaged, the boiler will not start operating while initializing. Wait for 5 minutes and start using the boiler as normal.
	Cannot turn off Eco Mode switch.	During DHW recirculation, Eco will always be on.

4.2 Diagnostic Codes

When the boiler detects an error or unexpected performance, a diagnostic code will display on the controller and a beeping sound will generate. Contact a qualified service provider whenever a diagnostic code shuts down the boiler.

Diagnostic Code	Diagnostic Code Cause
E:100	Air Supply or Exhaust Blockage/Condensate Trap is Full
E:110	No Ignition
E:120	Flame Failure
E:140	Heat Exchanger Overheat
E:150	Venturi Control
E:161	High Outgoing Temperature
E:170	Venturi Blockage
E:190	Electrical Grounding
E:250	Condensate Pump (Accessory)
E:310	Freeze Protection Thermistor
E:321	Outgoing Thermistor
E:331	Heat Exchanger Thermistor
E:341	Inlet Thermistor
E:353	Supply Thermistor
E:363	Return Thermistor
E:380	Exhaust Thermistor
E:393	Outdoor Thermistor
E:400	Pressure Sensor
E:430	High/Low Water Pressure
E:443	Low Water Cut Off
E:520	Solenoid Valve Circuit
E:540	High Exhaust Temperature
E:610	Combustion Fan
E:631	DHW Recirculation Pump
E:651	Water Flow Control
E:661	By-pass
E:670	3 Way Valves
E:681	Hot Water Supply Temperature Abnormality
E:700	PC Board
E:710	Solenoid Valve Circuit
E:720	Flame Rod
E:890	Freeze Issue
E:999	PC Board Mismatch
E:LC	Scale Build-up in Plate Heat Exchanger

4.2.1 Reset Diagnostic Codes

To reset a diagnostic code, either the **Central Heating** or **Domestic Hot Water** button will be blinking. Press this button to reset the code.

Notes:

- Diagnostic codes that occur during DHW operation may reset by turning off water flow from the fixture temporarily.
- Some diagnostic codes may not reset by pressing the **CH** or **DHW** buttons. In these cases, contact your service provider for troubleshooting assistance.

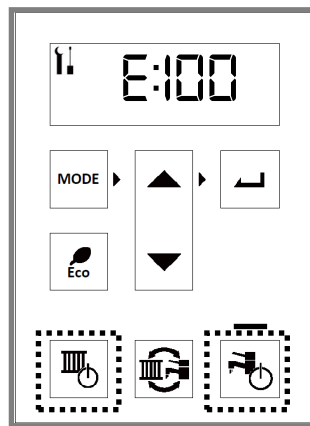

When an error code repeats itself, or if the error cannot be reset by following the above steps, contact a qualified licensed professional.

5

Maintenance

WARNING

- Maintenance is required to maintain safe operation of the boiler.
- The boiler must be inspected annually by a licensed professional. Repairs and maintenance shall be performed by a licensed professional. The licensed professional must verify proper operation after servicing.
- Keep the boiler area clear and free from combustible materials, gasoline, and other flammable vapors and liquids.
- To protect yourself from harm, before performing maintenance:
 - Turn off the electrical power supply by unplugging the power cord or by turning off the electricity at the circuit breaker. (The boiler controller does not control the electrical power.)
 - Turn off the gas at the manual gas control valve, usually located immediately below the boiler.
 - Turn off the incoming water supply. This can be done at the isolation valve immediately below the boiler or by turning off the water supply to the building.
- If you encounter a problem that is difficult to solve, stop the operation and immediately contact a licensed professional.

5.1 Owner Maintenance Schedule

MONTHLY

Boiler Area

Verify the area is free of combustible materials, gasoline and other flammable vapors and liquids.

Verify the area is clean from dust and obstructions.

Verify the air intake area is free of any contaminants listed in the “Rinnai I-Series Condensing Boiler Installation and Operation Manual.” Any contaminants in the boiler intake air vicinity must be removed. If they cannot be removed, contact a licensed professional.

Piping

Inspect all water, gas, and condensation piping for leaks. Look for signs of leaking lines or corrosion.

Confirm the condensation line is not blocked. If a condensation drain pump is used, confirm the condensation drain pump operates correctly.

Venting

Verify the boiler vent discharge and air intake is clean and free of obstructions.

Check for leakage, damage, or deformation of venting.

Boiler

Verify the boiler is free from any abnormal situations, such as diagnostic error codes, loud noises, leakage or other potential issues.

Check that the pressure on the controller display or external pressure gauge indicates 17 to 26 PSI (117 to 180 kPa).

5.2 Freeze Protection

Freeze Protection Operation

When the boiler detects low outdoor ambient temperatures, the boiler will begin its freeze protection operation. The freeze protection operation can protect the boiler from freezing down to as low as -22°F (-30°C) outdoor temperature.

When freeze protection is in operation, the pump may circulate water and/or the boiler may operate to prevent the boiler from freezing.

Ensure power and gas are supplied to the boiler for freeze protection to function.

The internal freeze protection will not necessarily prevent the system piping from freezing.

When freeze protection is active, the icon shown below will illuminate.

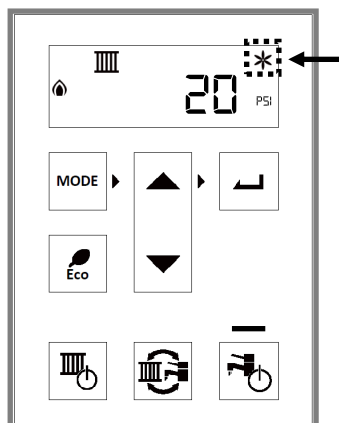

During freeze protection operation, the pressure and supply temperature will alternately display on the controller.

The icon for CH and DHW may alternate depending on the operation of the freeze protection sequence.

When the system needs to be shutdown for extended periods of time, the boiler and all system piping should be drained. The power and gas supply should then be disconnected from the boiler.

Freezing damage may occur if there is water remaining in the boiler or system piping. The plumbing lines should also be blown out via compressed air.

Notes

Notes

Notes



Learn more about Rinnai high-performance Tankless Boilers, Hybrid Water Heating Systems, Boilers, Vent-Free Fan Convectors and EnergySaver® Direct Vent Wall Furnaces at:

rinnai.us | rinnai.ca

Rinnai®

Rinnai America Corporation • 103 International Drive, Peachtree City, GA 30269
1-800-621-9419 • rinnai.us

©2019 Rinnai America Corporation. Rinnai America Corporation continually updates materials, and as such, content is subject to change without notice.

Local, state, provincial, federal and national fuel gas codes must be adhered to prior to and upon installation.

80000114

3/2019