

Technical Bulletin 149 - Ubbink Flexible Venting for SENSEI™ Tankless Water Heaters

PURPOSE: To announce the approval of Ubbink Rolux® flexible vent system components with the following internal (indoor) Rinnai SENSEI™ Condensing Tankless Water Heater models:

Residential	Residential (With Pump)	Commercial
RU199i (REU-N3237FF-US) RU180i (REU-N2934FF-US) RU160i (REU-N2530FF-US) RU130i (REU-N2024FF-US)	(ThermaCirc360™ Models) RUR199i (REU-NP3237FF-US) RUR160i (REU-NP2530FF-US)	CU199i (REU-N3237FFC-US) CU160i (REU-N2530FFC-US)

INSTALLATION REQUIREMENTS:

Vent Options	Room Air (Non-Direct Vent) applications ONLY. NOT approved for outside combustion air (Direct Vent).
Diameter	2 in. (60 mm)
Material	Polypropylene (PP) <i>DO NOT combine vent components from different manufacturers.</i>
Maximum Equivalent Vent Length	50 Ft (15 m)
Termination	Vertical only. <i>DO NOT run or terminate horizontally as condensate will not drain properly.</i>
Bending Conditions	<ul style="list-style-type: none"> Bend radius: Must be larger than 7 in. (178 mm) (Fig. 1) Angle: Do not install in angle over 45° to vertical (Fig. 2)
Clearances	0 (zero) clearance to combustible materials.
Installation Temperatures	Do not install while ambient temperatures are below 41°F (5°C). In colder weather, pre-warm flex venting prior to installation.
Additional Requirements	<ul style="list-style-type: none"> Vent system connects to only one Rinnai SENSEI™ Tankless Water Heater. Ubbink Rolux® venting components must be used throughout the entire vent system. Do not combine with vent components from other manufacturers. Do not store venting exposed to sunlight. Venting must be enclosed and used with a rigid PP pipe to connect to the tankless water heater (Fig. 3 on next page).
Approvals/Codes	Installation must conform to the Rinnai Tankless Water Heater Installation and Operation Manual that is shipped with the unit, local codes, or in the absence of local codes, with the National Fuel Gas Code, ANSI Z223.1/NFPA 54.

Fig. 1

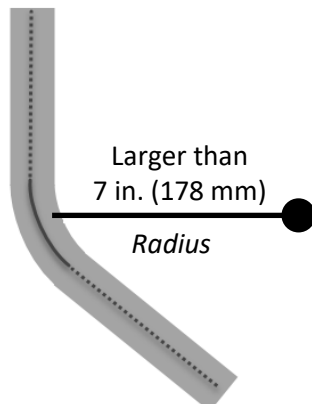
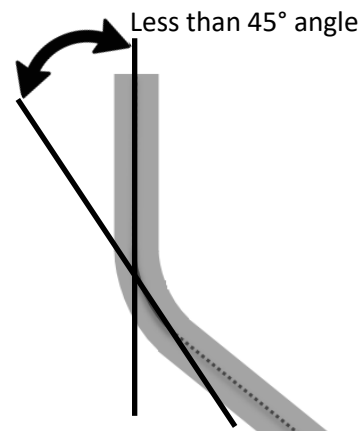
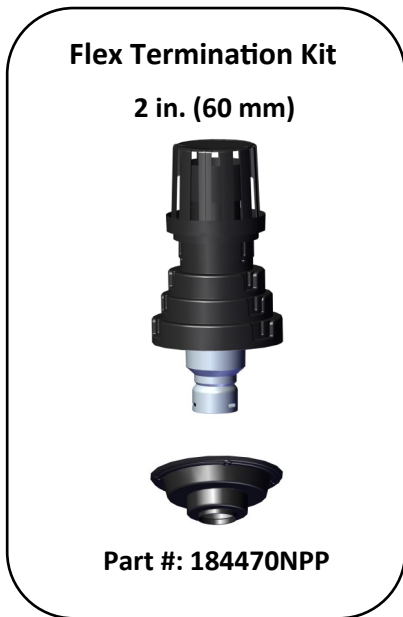

Fig. 2



COMPONENTS:



EXAMPLE CONFIGURATION:

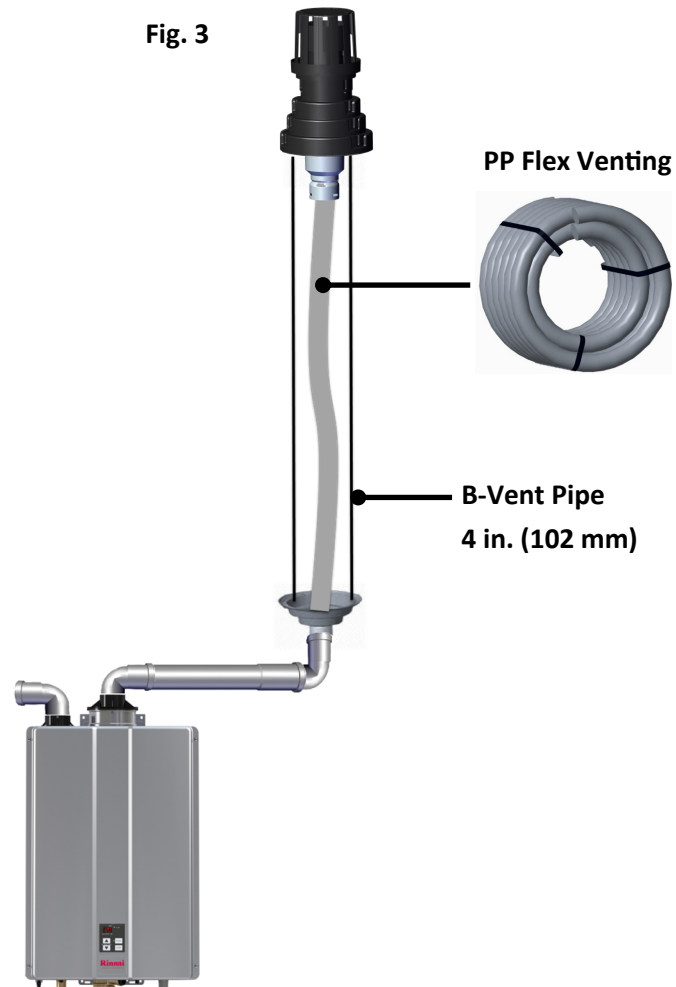

Rinnai America Corporation • 103 International Drive, Peachtree City, GA 30269

Toll-Free: 1-800-621-9419 • Phone: 678-829-1700 • www.rinnai.us

©2019 Rinnai America Corporation. Rinnai America Corporation continually updates materials, and as such, content is subject to change without notice. Local, state, provincial, federal and national fuel gas codes must be adhered to prior to and upon installation.