



12,000 BTU/H CEILING CASSETTE

SUBMITTAL COVER SHEET

PROJECT NAME _____

LOCATION _____

ARCHITECT _____

ENGINEER _____

CONTRACTOR _____

REFERENCE _____

SUBMITTED BY _____ DATE _____

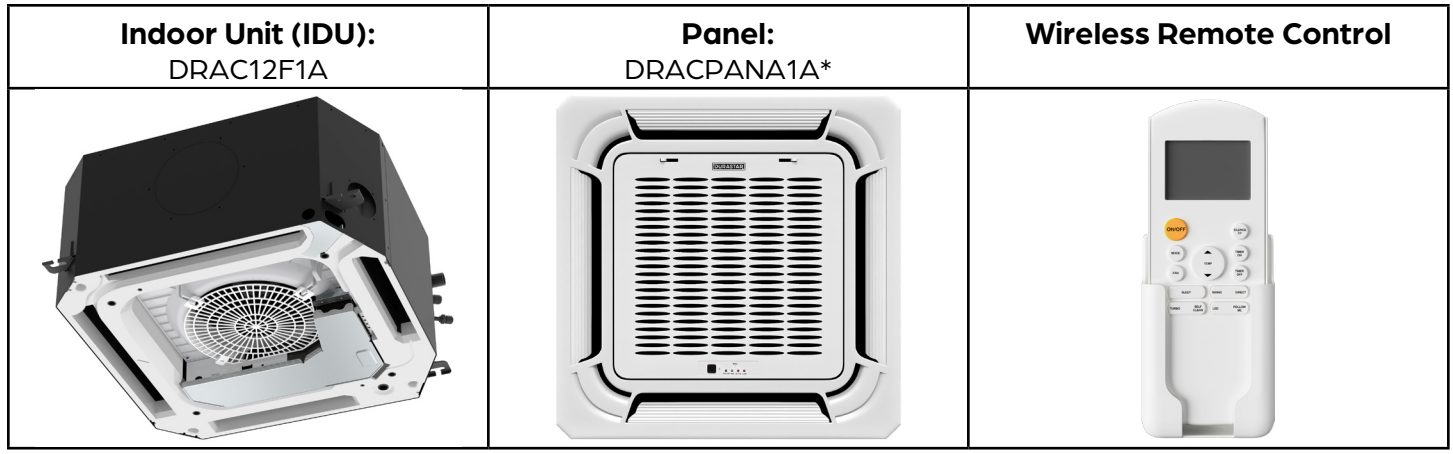

CAPACITIES		
Cooling Capacity (BTU/hr)	Rated	12000
Heating Capacity (BTU/hr)	Rated	12000

ELECTRICAL DATA	
Voltage/Phase/Frequency	208-230V, 1 Phase, 60 Hz

LINE SET REQUIREMENTS	
Connection Type	Flare
Liquid	Ø1/4" (Ø6.35mm)
Gas	Ø1/2" (Ø12.7mm)
Drain Port O.D. / Drain Hose I.D.	Ø1" (Ø25mm)

INDOOR UNIT FAN DATA		
Air Flow (CFM)	Low	261
	Medium	309
	High	379
Type	DC	
RLA	0.465	
Sound Pressure (dB(A))	Low	36
	Medium	39
	High	43

INDOOR UNIT DIMENSIONS		
Unit Dimensions	Width	22 7/16"
	Depth	22 7/16"
	Height	10 1/4"
Carton Dimensions	Width	26 1/16"
	Depth	26 1/16"
	Height	12 1/2"
Net Weight	35.3 lbs.	
Gross Weight	45.5 lbs.	

- PRODUCT FEATURES**
- Wireless Remote Control with "Follow Me" Technology
 - Auto Restart
 - Auto Changeover
 - 24-hour Timer
 - Self Clean Function

*Panel sold separately

Specifications are subject to change without notice.
 © 2021 Ferguson Enterprises LLC
 www.durastar.com





12,000 BTU/H CEILING CASSETTE

DIMENSIONS - DRAC12F1A

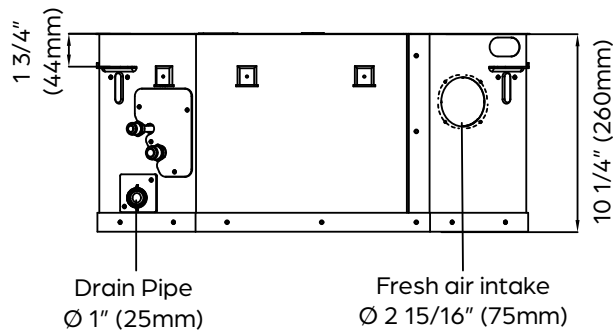
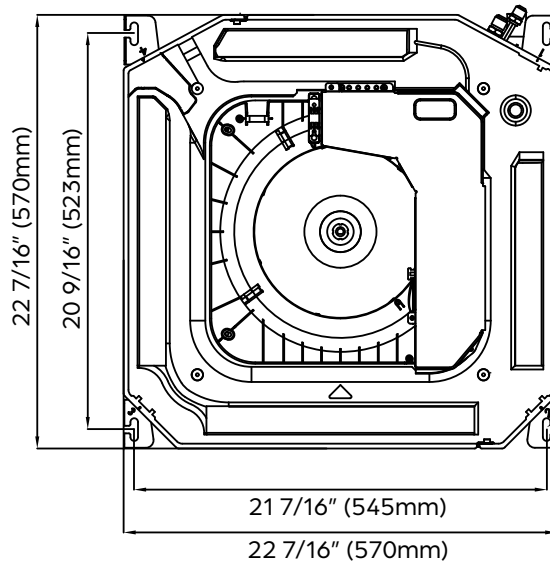

DRACPANA1A:

