

Instruction Manual

Wireless Remote Monitor System



Table of Contents

TABLE OF CONTENTS

SAFETY.....	Inside Front Cover
Read This Manual Thoroughly.....	1
Safety Rules	1
Operation and Maintenance.....	2
How to Obtain Service	3
INTRODUCTION	3
INSTALLATION	3
Generator Side Transceiver Installation Instructions	3
Synchronizing the Display	5
Re-assemble the Generator.....	6
Display Setup	6
THE COMMUNICATIONS LED	7
GENERATOR COMMUNICATIONS	7
THE DISPLAY	7
Buttons.....	7
Contrast Adjustment	7
Backlight	7
Battery and Signal Strength Indicators.....	7
ALARM AND STATUS DISPLAY	8
THE MENU SYSTEM	8
Status Menu	9
Test Menu.....	9
History Menu.....	9
SETTINGS MENU	9
Adjust Contrast.....	9
Choose Language.....	9
EXERCISE MENU	9
RADIO MENU	10
Radio Information	10
Changing Channels.....	10
Reset Radio	10
Add New Display	10
Test Radio Link	10
TIME & DATE MENU	11
GRAPH MENU.....	11
MENU MAP.....	12
FINAL ASSEMBLY DECAL DRAWING	13
WARRANTY	Back Cover

SAFETY

Compliance Statement (Part 15.19)

This device complies with Part 15 of the FCC Rules.

Operation is subject to the following two conditions:

1. This device may not cause harmful interference, and
2. This device must accept any interference received, including interference that may cause undesired operation.

Warning (Part 15.21)

Changes or modifications not expressly approved by the party responsible for compliance could void the user's authority to operate the equipment.

FCC Interference Statement (Part 15.105 (b))

This equipment has been tested and found to comply with the limits for a Class B digital device, pursuant to Part 15 of the FCC Rules. These limits are designed to provide reasonable protection against harmful interference in a residential installation. This equipment generates uses and can radiate radio frequency energy and, if not installed and used in accordance with the instructions, may cause harmful interference to radio communications. However, there is no guarantee that interference will not occur in a particular installation. If this equipment does cause harmful interference to radio or television reception, which can be determined by turning the equipment off and on, the user is encouraged to try to correct the interference by one of the following measures:

- Reorient or relocate the receiving antenna.
- Increase the separation between the equipment and receiver.
- Connect the equipment into an outlet on a circuit different from that to which the receiver is connected.
- Consult the dealer or an experienced radio/TV technician for help.

To comply with FCC/IC RF exposure limits for general population / uncontrolled exposure, the antenna(s) used for this transmitter must be installed to provide a separation distance of at least 20 cm from all persons and must not be co-located or operating in conjunction with any other antenna or transmitter.

RF Exposure (OET Bulletin 65)


To comply with FCC/IC RF exposure requirements for mobile transmitting devices, this transmitter should only be used or installed at locations where there is at least 20 cm separation distance between the antenna and all persons.

Section 7.1.5 of RSS-GEN

Operation is subject to the following two conditions:

1. This device may not cause interference, and
2. This device must accept any interference, including interference that may cause undesired operation of the device.

 **SAVE THESE INSTRUCTIONS** – This manual is in addition to the Owner's Manual for the generator. All warnings and recommendations in the manufacturer's manuals must be strictly adhered to for safe use.

 **SAVE THESE INSTRUCTIONS** – The manufacturer suggests that these rules for safe operation be copied and posted in potential hazard areas. Safety should be stressed to all operators, potential operators, and service and repair technicians for this equipment.

 **SAVE THESE INSTRUCTIONS** – This manual contains important instructions that should be followed during installation and maintenance of the generator and batteries.

READ THIS MANUAL THOROUGHLY

If any portion of this manual is not understood, contact the nearest Authorized Service Dealer for starting, operating and servicing procedures.

Throughout this publication, and on tags and decals affixed to the generator, DANGER, WARNING, CAUTION and NOTE blocks are used to alert personnel to special instructions about a particular service or operation that may be hazardous if performed incorrectly or carelessly. Observe them carefully. Their definitions are as follows:

DANGER!

INDICATES A HAZARDOUS SITUATION OR ACTION WHICH, IF NOT AVOIDED, WILL RESULT IN DEATH OR SERIOUS INJURY.

WARNING!

Indicates a hazardous situation or action which, if not avoided, could result in death or serious injury.

CAUTION!

Indicates a hazardous situation or action which, if not avoided, could result in minor or moderate injury.

NOTE:

Notes contain additional information important to a procedure and will be found within the regular text body of this manual.

These safety warnings cannot eliminate the hazards that they indicate. Common sense and strict compliance with the special instructions while performing the action or service are essential to preventing accidents.

Four commonly used safety symbols accompany the **DANGER**, **WARNING** and **CAUTION** blocks. The type of information each indicates is as follows:

 This symbol points out important safety information that, if not followed, could endanger personal safety and/or property of others.

 This symbol points out potential explosion hazard.

 This symbol points out potential fire hazard.


 This symbol points out potential electrical shock hazard.


SAFETY RULES


Study these SAFETY RULES carefully before installing, operating or servicing this equipment. Become familiar with this *Owner's Manual* and with the unit. The generator can operate safely, efficiently and reliably only if it is properly installed, operated and maintained. Many accidents are caused by failing to follow simple and fundamental rules or precautions.

The manufacturer cannot anticipate every possible circumstance that might involve a hazard. The warnings in this manual, and on tags and decals affixed to the unit are, therefore, not all-inclusive. If using a procedure, work method or operating technique the manufacturer does not specifically recommend, ensure that it is safe for others. Also make sure the procedure, work method or operating technique utilized does not render the generator unsafe.

DANGER!

 Despite the safe design of this unit, operating this equipment imprudently, neglecting its maintenance or being careless can cause possible injury or death. Permit only responsible and capable persons to operate or maintain this equipment.

 Potentially lethal voltages are generated by these machines. Ensure all steps are taken to render the machine safe before attempting to work on the generator.

 Parts of the generator are rotating and/or hot during operation. Exercise care near running generators.

CALIFORNIA PROPOSITION 65 WARNING

Engine exhaust and some of its constituents are known to the State of California to cause cancer, birth defects and other reproductive harm.

CALIFORNIA PROPOSITION 65 WARNING

This product contains or emits chemicals known to the State of California to cause cancer, birth defects and other reproductive harm.

Safety Rules

GENERAL HAZARDS

- For safety reasons, the manufacturer recommends that the installation, initial start-up and maintenance of this equipment is carried out by a Dealer.
- The engine exhaust fumes contain carbon monoxide, which can be DEADLY. This dangerous gas, if breathed in sufficient concentrations, can cause unconsciousness or even death. Do NOT alter or add to the exhaust system or do anything that might render the system unsafe or in noncompliance with applicable codes and standards.
- Keep hands, feet, clothing, etc., away from drive belts, fans, and other moving or hot parts. Never remove any drive belt or fan guard while the unit is operating.
- Adequate, unobstructed flow of cooling and ventilating air is critical to correct generator operation. Do not alter the installation or permit even partial blockage of ventilation provisions, as this can seriously affect safe operation of the generator. The generator MUST be installed outdoors.
- When working on this equipment, remain alert at all times. Never work on the equipment when physically or mentally fatigued.
- Inspect the generator regularly, and contact the nearest Dealer for parts needing repair or replacement.
- Before performing any maintenance on the generator, disconnect its battery cables to prevent accidental start up. Disconnect the cable from the battery post indicated by a NEGATIVE, NEG or (-) first, then remove the POSITIVE, POS or (+) cable. When reconnecting the cables, connect the POSITIVE cable first, the NEGATIVE cable last.
- Never use the generator or any of its parts as a step. Stepping on the unit can stress and break parts, and may result in dangerous operating conditions from leaking exhaust gases, fuel leakage, oil leakage, etc.

ELECTRICAL HAZARDS

- All generators covered by this manual produce dangerous electrical voltages and can cause fatal electrical shock. Utility power delivers extremely high and dangerous voltages to the transfer switch as does the standby generator when it is in operation. Avoid contact with bare wires, terminals, connections, etc., while the unit is running. Ensure all appropriate covers, guards and barriers are in place, secured and/or locked before operating the generator. If work must be done around an operating unit, stand on an insulated, dry surface to reduce shock hazard.
- Do not handle any kind of electrical device while standing in water, while barefoot, or while hands or feet are wet. DANGEROUS ELECTRICAL SHOCK MAY RESULT.
- The National Electrical Code (NEC) requires the frame and external electrically conductive parts of the generator to be connected to an approved earth ground. Local electrical codes also may require proper grounding of the generator electrical system.

- After installing this home standby electrical system, the generator may crank and start at any time without warning. When this occurs, load circuits are transferred to the STANDBY (generator) power source. To prevent possible injury if such a start and transfer occur, always set the generator's AUTO/OFF/MANUAL switch to its OFF position before working on equipment and remove the 15A fuse from the generator control panel.
- In case of accident caused by electric shock, immediately shut down the source of electrical power. If this is not possible, attempt to free the victim from the live conductor. AVOID DIRECT CONTACT WITH THE VICTIM. Use a nonconducting implement, such as a dry rope or board, to free the victim from the live conductor. If the victim is unconscious, apply first aid and get immediate medical help.
- Never wear jewelry when working on this equipment. Jewelry can conduct electricity resulting in electric shock, or may get caught in moving components causing injury.

FIRE HAZARDS

- For fire safety, the generator must be installed and maintained properly. **Installation must always comply with applicable codes, standards, laws and regulations.** Adhere strictly to local, state and national electrical and building codes. Comply with regulations the Occupational Safety and Health Administration (OSHA) has established. Also, ensure that the generator is installed in accordance with the manufacturer's instructions and recommendations. Following proper installation, do nothing that might alter a safe installation and render the unit in noncompliance with the aforementioned codes, standards, laws and regulations.
- Keep a fire extinguisher near the generator at all times. Extinguishers rated "ABC" by the National Fire Protection Association are appropriate for use on the standby electric system. Keep the extinguisher properly charged and be familiar with its use. Consult the local fire department with any questions pertaining to fire extinguishers.

EXPLOSION HAZARDS

- Do not smoke around the generator. Wipe up any fuel or oil spills immediately. Ensure that no combustible materials are left in the generator compartment, or on or near the generator, as FIRE or EXPLOSION may result. Keep the area surrounding the generator clean and free from debris.
- Gaseous fluids such as natural gas and liquid propane (LP) gas are extremely EXPLOSIVE. Install the fuel supply system according to applicable fuel-gas codes. Before placing the home standby electric system into service, fuel system lines must be properly purged and leak tested according to applicable code. After installation, inspect the fuel system periodically for leaks. No leakage is permitted.

OPERATION AND MAINTENANCE

The operator is responsible for proper and safe use of the equipment. The manufacturer strongly recommends that the operator read this Owner's Manual and thoroughly understand all instructions before using this equipment. The manufacturer also strongly recommends instructing other users to properly start and operate the unit. This prepares them if they need to operate the equipment in an emergency.

It is the operator's responsibility to perform all safety checks, to make sure that all maintenance for safe operation is performed promptly, and to have the equipment checked periodically by an Authorized Service Dealer. Normal maintenance service and replacement of parts are the responsibility of the owner/operator and, as such, are not considered defects in materials or workmanship within the terms of the warranty. Individual operating habits and usage contribute to the need for maintenance service.

Proper maintenance and care of the generator ensures a minimum number of problems and keeps operating expenses at a minimum. See an Authorized Service Dealer for service aids and accessories.

Operating instructions presented in this manual assume that the standby electric system has been installed by an Authorized Service Dealer or other competent, qualified contractor. Installation of this equipment is not a "do-it-yourself" project.

HOW TO OBTAIN SERVICE

When the generator requires servicing or repairs, contact an Authorized Service Dealer for assistance. Service technicians are factory-trained and are capable of handling all service needs (1-888-GENERAC).

When contacting an Authorized Service Dealer about parts and service, always supply the complete model number of the unit as given on the front cover of this manual or on the DATA LABEL affixed to the unit.

INTRODUCTION

The wireless remote monitor system consists of two identical radio transceivers, one mounted near the generator (generator transceiver) and the display which should be located in a convenient viewing location. The system has a "line of sight" range of about 300 feet but this will be reduced if the signal has to go through walls, floors, etc. of a typical installation.

NOTE:

Some building materials may completely block the passage of the signal. For example: steel beams, metal siding, foil radiant barrier insulation.

The display is intended to show the status of the generator and warn you if the system is in an alarm state. It also provides the following additional functions:

- An independent (of the generator Alarm log) time/date stamped history of generator events such as starting and stopping
- Allows remote starting and stopping of the generator
- Facility to set an exercise time and day from the display
- A separate battery backed clock (with date facility) which is synchronized to the generator clock. If power is removed from the generator, time and date can be automatically restored from this clock.
- Ability to add extra displays
- Graphing capability

The unit is powered by the supplied AC adaptor. The AAA batteries are only intended to provide power in the event of a utility failure or temporary portable use; they are not intended for extended use. When operating on the AAA batteries alone, the unit will go to sleep for 60 seconds then exchange data for up to two (2) seconds to conserve battery life. The display screen will turn off in the sleep mode unless there is an alarm to be displayed. It can be awoken by pressing the ENTER key after which it will remain awake for 30 seconds if no further keys are pressed. The batteries are NOT used to retain data such as the history log or the radio settings. These will not be lost in the event of a dead battery. Rechargeable batteries can be used but are NOT recharged by the AC adaptor and should be separately charged.

NOTE 1:

In battery sleep mode it will take up to two (2) minutes to detect if the radio link is lost. This long delay is to allow for the unit's sleep time.

NOTE 2:

In battery sleep mode, if the wall transformer is plugged into the unit, it will take up to one minute to recognize this fact.

INSTALLATION

GENERATOR SIDE TRANSCEIVER INSTALLATION INSTRUCTIONS

The following steps will illustrate how to mount the generator side transceiver to the generator.

1. Open the top lid of the generator.
2. Set the Auto/Off/Manual switch to the Off position.
3. Remove the 7.5 Amp control panel fuse
4. Remove the front access panel from the enclosure.
5. Disconnect the Negative battery cable.
6. If installing after the generator has been connected to utility power, OPEN (turn OFF) the main breaker in your home's utility breaker electrical panel.
7. Remove retaining screws and then remove the control panel cover (Figure 1).

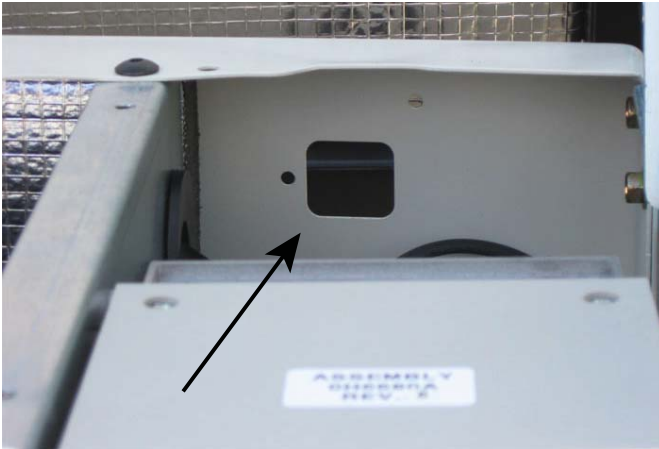
Figure 1 — Remove Control Panel Cover



Wireless Display System

8. Remove the cover plate and rubber gasket from the back side of the generator (Figure 2).
9. Remove the generator transceiver from the package and verify the gasket is properly located in its groove.

Figure 2 — Remove Cover Plate & Rubber Gasket



10. Mount the generator transceiver to the generator using the two (2) screws and flat washers provided (Figure 3).

Figure 3 — Mount Transceiver



11. Plug either end of the wire harness provided in the kit into the transceiver module aligning the plug latch with the header latch (Figure 4).

NOTE:

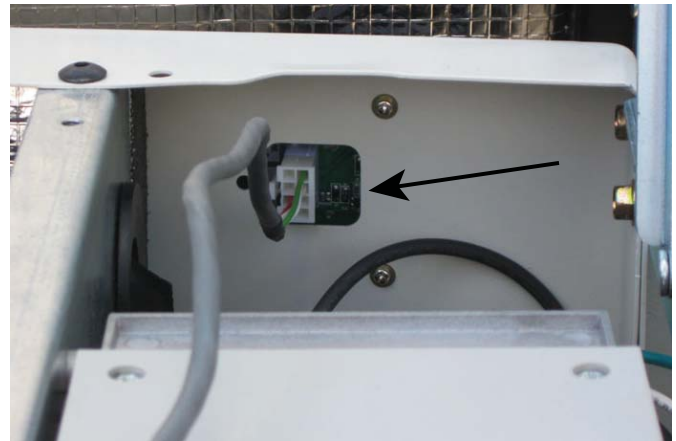
The plug will only plug into the header one way – DO NOT force the plug into the header; gently insert the plug until it locks into place.

NOTE:

For generators with the 2010 style controller (0H6680 series), follow steps 11, 12, 16 and 17.

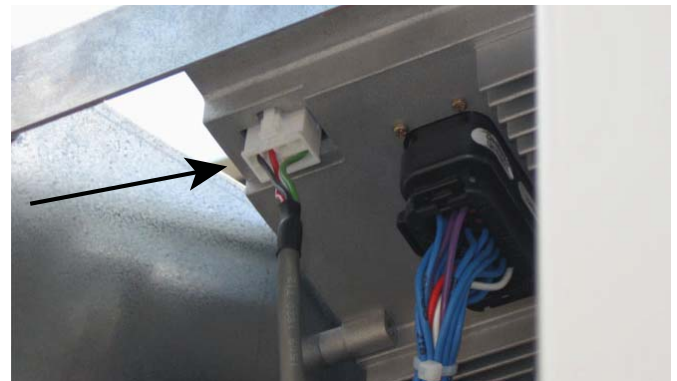
For generators with the 2008 style controller, follow steps 11 and 13 through 17.

Figure 4 — Plug in Wire Harness



12. Plug the remaining end of the wire harness into the 8-way connector at the bottom front of the control panel. The plug will only plug in one way (Figure 5A). **DO NOT force the plug into the header. Gently insert the plug until it locks into place.**

Figure 5A — Plug Wire Harness into 8-pin Header



13. Route the wire under the control panel (Figure 6A).

Figure 6A — Route Wire



14. Undo the four (4) screws holding the control panel and raise up the front end of the control panel. Plug the the remaining end of the wire harness into the 8-way connector at the top of the control panel. The plug will only plug in one way (Figure 5B). **DO NOT force the plug into the header. Gently insert the plug until it locks into place.**

Figure 5B — Plug Wire Harness into 8-pin Header



15. Lay the control panel back down and reinstall the four (4) screws.
16. Route the wire in the channel along the left hand wall along with the other wires (Figure 6B).

Figure 6B — Route Wire



17. If applicable, CLOSE (turn ON) the breaker in the home's utility breaker electrical panel.
18. Reconnect the Negative battery cable.
19. Replace the 7.5 Amp control panel fuse.

SYNCHRONIZING THE DISPLAY

The following steps illustrate how to synchronize the display to the generator transceiver.

Before beginning, ensure the top lid is open, the switch is in off, the 7.5A control panel fuse is removed and the control panel cover is removed. If not, see the previous INSTALLATION section for instructions.

1. Remove the battery door from the back of the display (Figure 7), and insert the three AAA batteries included (Figure 8). Observe correct battery polarity which is indicated in the battery compartment.

Figure 7 — Remove Battery Door



Figure 8 — Insert Batteries



2. Replace the battery door.
3. Take the display to the generator and ensure the display is off using the slide switch on the side of the unit.
4. Unplug the white 8-pin connector from the transceiver module (refer back to Figure 4).

Wireless Display System

- Turn on the display and check to see if it enters automatic synchronization mode which will be indicated by the display showing "searching for generators."
 - If the display does enter automatic synchronization mode, immediately (within 5 seconds) reinsert the white 8-pin plug into the generator transceiver (the plug just removed in step 4).
Skip to step 7.
 - If the display does not enter automatic synchronization mode within 15 seconds, go to the radio menu and proceed with step 6.
- Select "reset radio" and press enter, then immediately (within 5 seconds) reinsert the white 8-pin plug into the generator transceiver (the plug removed in step 4).
- Close the generator lid so it won't interfere with the radio signal.
- The display will search for the generator transceiver. Up to one minute will pass while the display and generator transceiver synchronize. Once the generator transceiver is found, the radio link has been established and the settings will be remembered.
- Once the link is established, the display will "remember" its own generator and will not need to search for it again even after it is turned off and back on, or if the AAA batteries are removed and replaced.
- If the generator transceiver is not found, an error message will be briefly shown indicating the display was unable to find the generator transceiver. If this happens repeat steps 3 through 8 with the display closer to the generator or moved to be more in a direct line of sight of the generator transceiver.
- If the generator controller is not communicating with the generator transceiver, but the generator transceiver is communicating to the display, this will be indicated by an appropriate alarm which will be displayed on the display after a 30 second period. Check the wiring connections between the generator controller and the generator transceiver.

NOTE:

If the power to the generator transceiver is removed, the radio system will stop working and **WILL NOT AUTOMATICALLY resynchronize** when the power is returned. To resynchronize the system follow steps 3 through 8 above.

RE-ASSEMBLE THE GENERATOR

- Open the top lid of the generator.
- Remove the 7.5 Amp control panel fuse.
- Replace the control panel cover and retaining screws.
- Replace the front access panel.
- Replace the 7.5 Amp control panel fuse.
- Set the AUTO/OFF/MANUAL switch to the AUTO position.
- Close the generator lid.

DISPLAY SETUP

- Place the display in the preferred location and ensure there is an AC outlet within reach of the AC adaptor cable. Remember the display needs to be powered from an AC outlet during normal operation. The AAA batteries are only intended to provide power in the event of a utility failure or temporary portable use.

Do not permanently mount the display at this time.

- Plug the AC adaptor into the display and the AC wall outlet.
- Check the radio signal strength which is indicated by the signal strength bars on the display (Figure 13.) Note that it takes a few seconds for the signal strength display to update. Relocate the display if the signal strength is weak or no signal.
- Once a suitable location is found and the signal strength verified, mount the display. The display can either be placed on a table top using the cradle provided (Figure 10) or wall mounted.

When wall mounted the display can either be directly mounted to the wall, or mounted to the wall using the cradle provided. In either case the display should be mounted between two studs for maximum signal strength.

When direct mounting refer to Figure 9 for mounting hole locations. When using the cradle for wall mounting the cradle may be used as a template for marking the holes.

If the cradle is used (Figure 10), excess cable can be retained inside the cradle using the posts provided (Figure 11).

- Set the time and date into the clock using the instructions given in the "Time and Date Menu" section. The time and date will be remembered even if the batteries go dead.
- Set an exercise day and time now (see "Exercise Menu" section).

Figure 9 — Mounting Holes

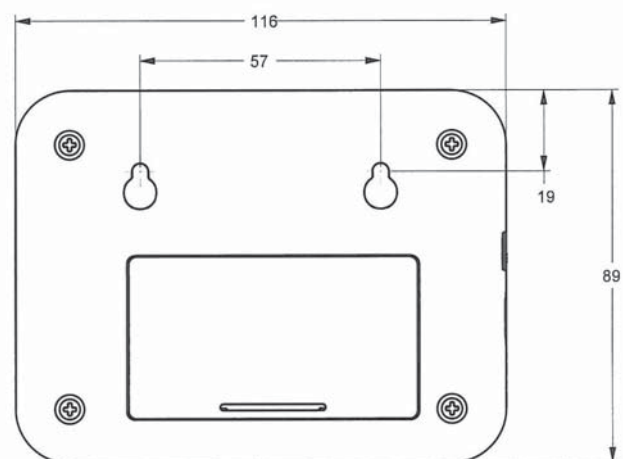


Figure 10 — Display Mounted in Cradle



Figure 11 — Cable Wrap Posts

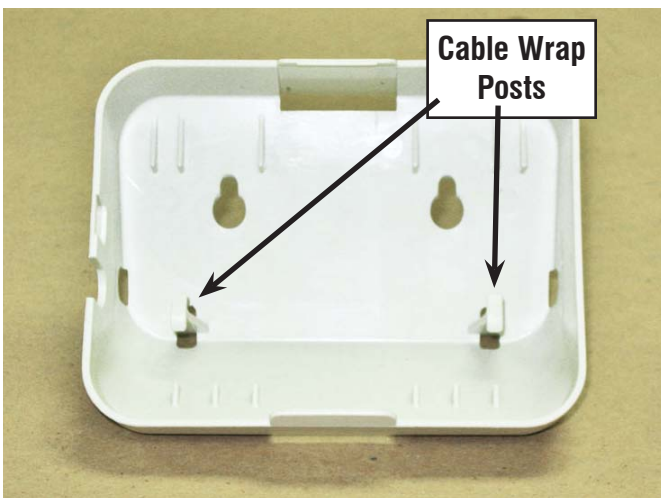


Figure 12 — Sample Alarm



THE DISPLAY

BUTTONS

Operation of the display is controlled by three (3) buttons labeled Δ , ∇ , and Enter. These buttons are used to navigate the display to the required page, or to enter data. The Δ , ∇ buttons are also referred to as the arrow keys. Holding down a button for more than half a second will cause it to auto repeat until it is released.

CONTRAST ADJUSTMENT

The display contrast can be adjusted from the “Settings” menu. Any changes to the contrast setting will be remembered even if power is removed from the display.

BACKLIGHT

The backlight is lit whenever a key is pressed. It will remain lit for 20 seconds if there are no further key presses. If an alarm occurs, the backlight will flash at a one (1) second rate (not if battery powered).

BATTERY AND SIGNAL STRENGTH INDICATORS

In the top left corner of the display, there are two icons (or pictures) that give a quick indication of the state of the internal battery and the radio signal strength (Figure 13). The battery is represented by the left hand, single tall rectangle which is drawn as being somewhere between full and empty. Full represents greater than 75% capacity, mostly full represents 50-75% capacity, half full represent 25-50% and mostly empty represents 0-25% capacity. The signal strength icon is shown to the right of the battery icon as three vertical bars representing greater than 25%, greater than 50%, and greater than 75%. Three bars indicate excellent signal strength, two bars represent good signal strength, one bar represents weak signal strength. Two or three bars is the normal indication.

THE COMMUNICATIONS LED

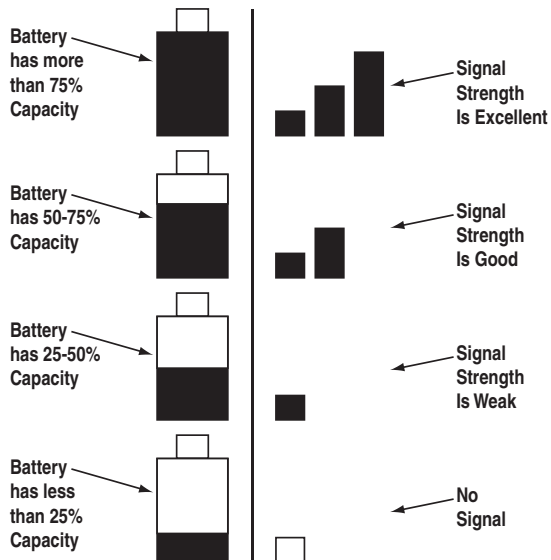
The communications LED will light continuously to show data is being received. If the LED flashes at regular one (1) second intervals, it indicates the unit was unable to find the generator. Irregular flashing is an indication of poorer reception. The LED will not function as described here if the display is operating on battery power.

GENERATOR COMMUNICATIONS

The transceiver requests data from the generator every two (2) seconds and this is stored inside the transceiver locally. The data is relayed to the base station over the radio link every time it is requested by the display, about every two (2) seconds. When on battery power, the data is only requested every minute to conserve batteries. If the generator is not communicating with its transceiver, but the radios are communicating to each other, this will be indicated by an appropriate alarm which will be displayed after a seven (7) second period (Figure 12). Check the wiring and connection to the generator.

Wireless Display System

Figure 13 — Battery & Signal Strength

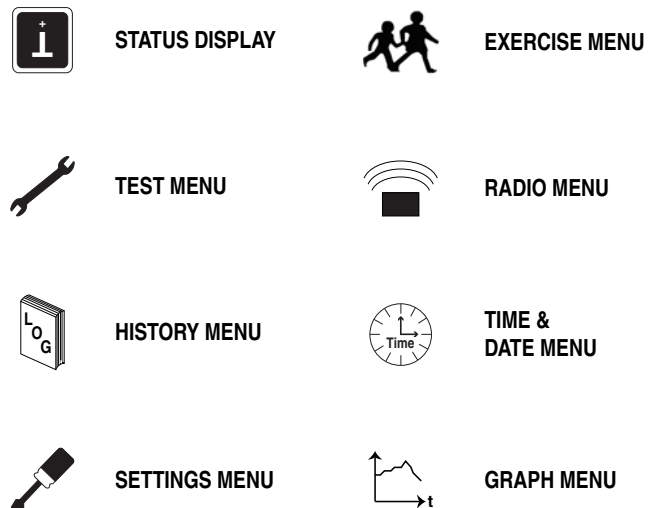


When an alarm occurs, the display will show a flashing alarm icon and the alarm message. The backlight will also flash if not in battery mode. If the alarm goes away, the display will revert to the status display. If two or more alarms exist, the most recent one to occur will be displayed. If the enter key is pressed to go into menu mode, when returning to the alarm display, the latest alarm will be displayed.

THE MENU SYSTEM

Pressing the Enter key will switch the display into menu mode (Figure 16). If no further keys are pressed for 30 seconds, the unit will revert back to the status display. Menu Mode is indicated by a menu name on the right side of the display, and an icon (picture) on the left side. Use the up/down arrow keys to move to the menu required, then press the enter key to see the choices.

Figure 16 — Menu System



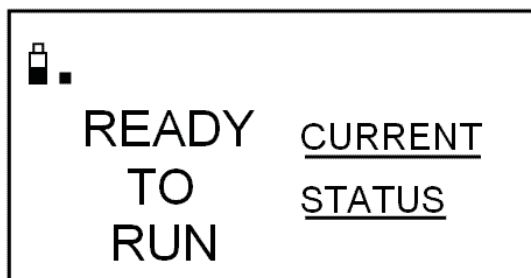
ALARM AND STATUS DISPLAY

The display will normally show the operating status of the generator or an alarm message if one is present. See Figures 14 and 15.

Figure 14 — Sample Alarm Screen

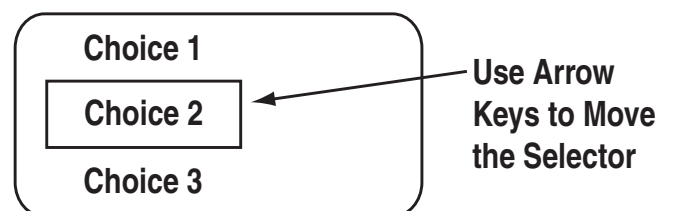


Figure 15 — Sample Status Screen



Once a menu is selected, there will be a list of choices. The current choice is shown by a rectangle drawn around it (Figure 17). Use the arrow keys to navigate the rectangle to the topic required, then press the enter key.

Figure 17 — Menu Choices



When the enter key is pressed, the display switches into menu mode which will allow access to the special functions of the unit. If no keys are pressed for 30 seconds, the unit will revert back to the status or alarm display.

STATUS MENU



The status menu item simply provides a way to show the current status message coming from the generator. This is shown as a text message on the LEFT hand side of the display. Normally this will show the following message: "READY TO RUN".

TEST MENU



The test menu permits starting and stopping the generator. Use the arrow keys to navigate to the appropriate option. If choosing to start the generator, the two arrow keys will need to be pressed together to confirm the command. To cancel the command, press the enter key.

If there is an automatic transfer switch, there is the option to run the generator and transfer onto generator power. Once the generator is started or stopped, the state of the generator will be shown by a "*" symbol next to the command issued.

For example:

- | | |
|-------------------|--|
| Normal Start* | You started the generator at normal speed. |
| Start & transfer* | You started the generator & transferred to generator power |
| Stop generator* | You stopped the generator |

There is a one minute cool down time after you stop the generator, so it will continue to operate for one minute after the stop command is issued. In the event that the stop command fails (such as if you take the display out of range, you can either retry the stop command or manually stop the generator by switching it to the "off" position.

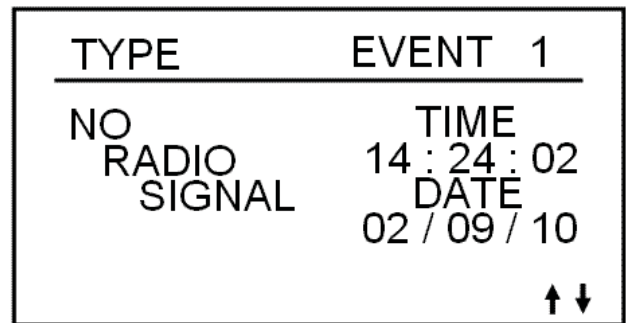
HISTORY MENU



The history log is a chronological list of "events" that have occurred to the generator. An event is any change in status such as an alarm, a start or stop, the key switch being operated, etc.. These events are permanently stored inside the display module along with a time and date stamp when they occurred. They will not be lost even if the battery goes dead, but there is the option to erase the log. This log is independent of the log displayed at the generator and will log ALL events, not just alarms.

When entering the history menu, the most recently logged event (Event 1) will be displayed. The actual event will be shown as a message on the left hand portion of the screen (Figure 18). The time and date of the event will be shown on the right hand part of the screen, and the event number displayed on the underlined title bar. By using the arrow keys, navigate through the events which are stored in chronological order. Event 1 is the most recent and event 100 is the oldest. The events are stored in a circular fashion so it's possible to scroll from Event 1 back to event 100 by using the "UP" arrow key. The history log can be cleared from the "SETTINGS" menu.

Figure 18 — History Menu



SETTINGS MENU



The following list of options will be presented:

- Adjust Contrast
- Clear History
- Add Me to Network
- Choose Language

ADJUST CONTRAST

The display contrast can be adjusted using the two arrow keys. Once the desired contrast level is reached, press the enter key to store it.

CHOOSE LANGUAGE

The display can be set to any one of three (3) languages. The choices are English, French, and Spanish. This can be changed at any time by scrolling to the settings page and selecting "Choose Language". This setting is saved until changed by the user. Removing power or removing batteries will not change this setting.

EXERCISE MENU



Normally the exercise time is set at the generator control board. If an exercise time has not been set on the control board, it will flash an alarm message and an alarm will also be set on the wireless display – "EXERCISE TIME NOT SET".

The exercise page of the wireless display can be used to overwrite any exercise time set in the generator. Use the arrow keys and follow the on-screen instructions to set the time and day of the exercise. The data will be sent to the generator. Confirm it by rechecking the exercise time on the base station display after a few seconds (it takes a few seconds for the radio to update its data).

The wireless display calculates the difference in time from the exercise date and time to the current date and time, and downloads this to the generator. This means the clock on the generator and the clock in the base station must be synchronized, this is normally the case and it is automatically checked and corrected every ten minutes. The exercise cycle is repeated at the same time weekly and does not use the wireless system to do this, all the timing is in the generator.

RADIO MENU



The following list of options will be presented:

- Radio information
- Change Channel
- Reset Radio
- Add New Display
- Test Radio Link

RADIO INFORMATION

This selection shows statistics about the radio link. There is a display of signal quality as a percentage, as well as an indication of the current system channel. For ease of use, the display will NOT revert to the status/alarm screen after 30 seconds if no keys are pressed.

If the signal quality is low but the signal strength is good, there may be some interference. See the section on "Changing Channels".

CHANGING CHANNELS

Channel selection is normally automatic, manually changing channels should only need to be done if experiencing interference from other equipment. This can be identified by looking at the signal strength and the signal quality. If the signal strength is good but the quality is not, there may be some interference. Changing channels on the main display will automatically change the channel on the generator end provided a link has been established. If the "change channel" message fails for any reason, the units will revert to their old channel selection. A new channel setting will be remembered for the next time the unit is powered up. To change channels on an established and working link, simply select "Change Channel" from the Radio menu, then enter a new channel number.

Changing the channel number on a link that is not established is a little more complex, the only reason this may need to be done is if a link cannot be establish because the default channel is noisy. To perform this task, follow these instructions:

1. Remove power from the generator transceiver by unplugging the 8-pin connector from the generator transceiver (refer back to the "Synchronizing the Display" section and to Figure 4.)
2. On the display, go to the radio menu and select "Reset radio" and press enter. This will try to establish a link but it will fail. The process will take about one minute.
3. Go to "Change Channel" and select a new channel. There are 16 channels to choose from.
4. Go back and select the "Reset Radio" command.
5. Immediately (within 5 seconds) reinsert the white 8-pin plug into the generator transceiver (the plug just removed).
6. The radio link should establish itself on the channel selected. This will be remembered even when the power is turned off to the display.

If the unit is a secondary display, no checking is done to ensure the channel matches the current system channel. Set the channel to the current system channel. Look on the main display and select the radio menu, then select "Radio Information". This will tell you the current channel that is being used.

RESET RADIO

Normally the system will set itself up out of the box. However, if either of the transceivers need to be replaced (the display or the generator transceiver), the system will need to be re-synchronized and the exercise time re-set. You will NOT have to re-synchronize the system if the battery in the display is discharged, the system will remember the radio settings.

If communications are totally lost due to the power being removed from the generator transceiver, or for an unexplained reason, you will need to resynchronize the system. To do this, repeat the steps in the SYNCHRONIZING THE DISPLAY section.

ADD NEW DISPLAY

An extra remote display can be added to the network. Each display needs to be trained as to what its network consists of. This is the function of the "Add New Display" selection.

1. Locate the new display near the main display and turn it on.
2. On the NEW display, go to the "Settings" menu and select "Add me to Network".
3. Choose a unique address for the additional display, for example one that does not conflict with any other additional displays. If there are only two displays, then any number (other than zero), will do. Zero is used to cancel the command.
4. On the MAIN display go to the radio menu and select "Add New Display". Press enter on both displays. A countdown timer will be displayed as the two units re-train.
5. At the end of the period, the new display will show that the training was successful.

TEST RADIO LINK

This feature allows the "basic" data integrity of the link to be tested, it may not be necessary to use this feature. For ease of use, the display will NOT revert to the status/alarm screen after 30 seconds if no keys are pressed.

Test data is sent over the link to the generator end, and then sent back from the generator end to the display. The data received is displayed on the bottom line of the display. Good data is shown as a series of forward slashes (/////). Time-outs on the link are displayed as the "#" character and corrupted data reply messages are shown as the "@" character. The messages are termed "basic" because they are not error checked or corrected.

Radio information such as channel number and quality are also shown alongside the test data.

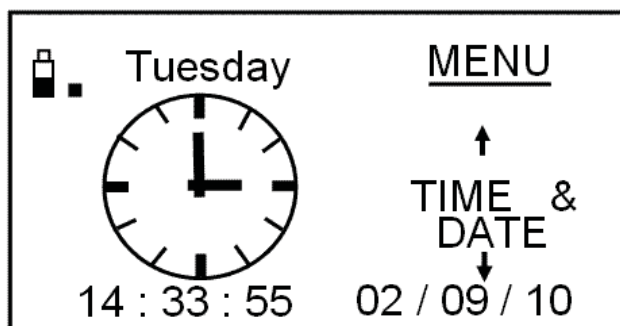
TIME & DATE MENU



There is a live, updating display of the current time, day, and date shown on the menu icon page (Figure 19).

Selecting this menu permits setting the clock to the correct time, day and date. This will only need to be done the first time the display is powered up, or to correct any small errors in the time. Use the two arrow keys to set the correct time, day and date.

Figure 19 — Time & Date Menu



The separate clock in the generator is synchronized to this clock when it is changed. Synchronization is checked and corrected, if necessary, every ten minutes. If the clock or date is changed at the generator, the clock at the display is also changed automatically (The two clocks are linked together and can be changed at either end of the link).

GRAPH MENU

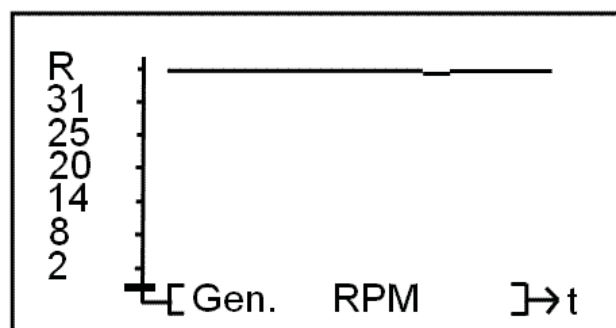


The Graph menu permits graphing data in real time on a rolling screen (Figure 20). Choose what to graph from the following list:

- Utility Voltage
- Generator Battery Volts
- Generator RPM (in units of RPM x 100)

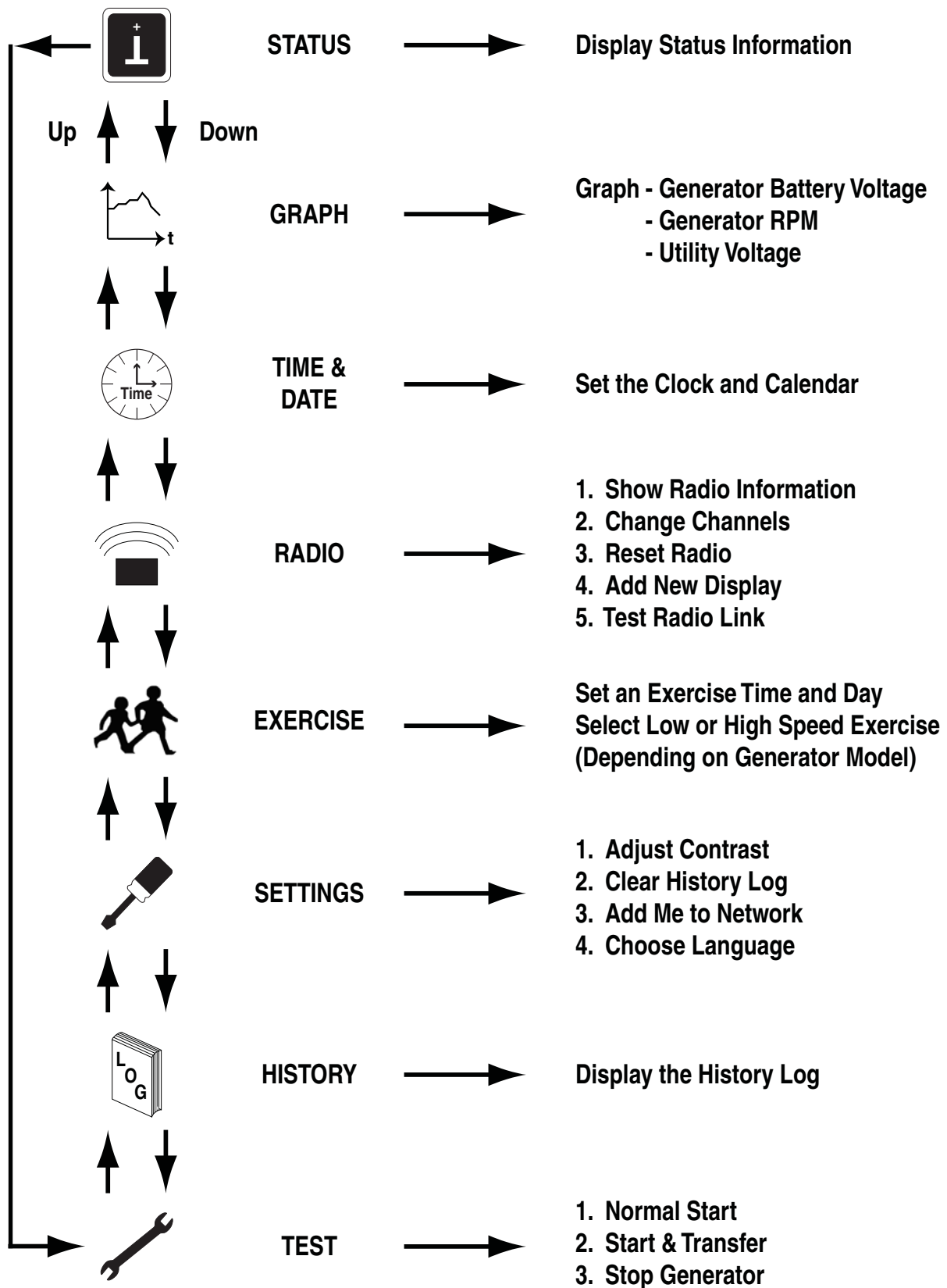
The display is updated with a new point every 200ms so it takes about 25 seconds to scroll the whole screen. However new data is only read from the generator every two (2) seconds.

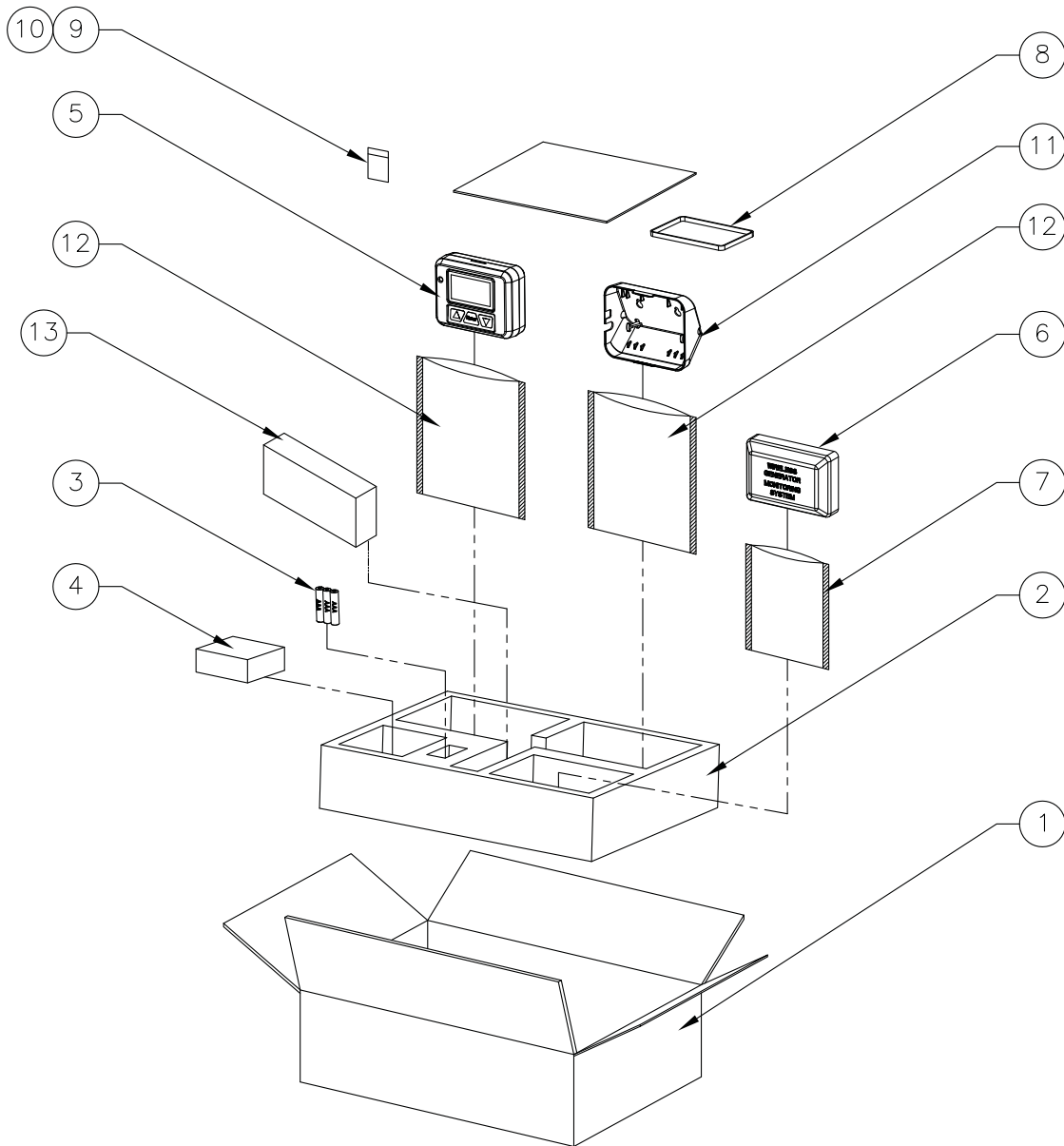
Figure 20 — Sample Graph of Engine RPM



Wireless Display System

MENU MAP





ITEM	PART NO.	QTY.	DESCRIPTION
1	OG7127	1	CARTON 306 X 227 X 80
2	OH8815	1	PE FOAM
3	OG7161	3	BATTERY, AAA
4	OG4904	1	AC ADAPTOR, 120Vac / 5Vdc
5	OG6020	1	HOME SIDE RF ANNUNCIATOR
6	OG6019	1	GENERATOR SIDE RF ANNUNCIATOR
7	OG7130	1	STATIC SHIELDING BAG, 200 X 140 X 0.08t
8	OG7092	1	GASKET, 2.0 X 4.0 X 313
9	O84543A	2	SCREW PPPH 3 X 12mm
10	O52777	2	WASHER FLAT M3
11	OH8023	1	CRADLE
12	OH8817	2	STATIC SHIELDING BAG, 250 X 200 X 0.08t
13	OG8856	1	HARN PCB-RF MOD

Warranty

GENERAC POWER SYSTEMS "180 DAY" LIMITED WARRANTY FOR WIRELESS REMOTE MONITOR (for AIR-COOLED GENERATORS)

For a period of 180 days from the date of original sale, Generac Power Systems, Inc. (Generac) warrants its wireless remote monitor will be free from defects in materials and workmanship for the items and period set forth below. Generac will, at its discretion, repair or replace any part that, upon examination, inspection and testing by Generac or a Generac Authorized Warranty Service Dealer, is found to be defective. Any equipment that the purchaser/owner claims to be defective must be returned to and examined by the nearest Generac Authorized Warranty Service Dealer. All transportation costs under the warranty, including return to the factory, are to be borne and prepaid by the purchaser/owner. This warranty applies only to Generac wireless remote monitor and is not transferable from original purchaser.

The warranty period begins on the date of purchase by the first retail end user, and continues for the period of time stated above. "Consumer Application" means personal residential household use by a retail consumer. No other use is warranted.

CONSUMER APPLICATION

180 Day - Limited comprehensive coverage on Labor and Parts

THIS WARRANTY SHALL NOT APPLY TO THE FOLLOWING:

1. Any travel expenses to troubleshoot, remove, replace or adjust a part(s).
2. Normal customer maintenance items.
3. Failures due, but not limited, to the following:
 - Storage
 - Improper installation
 - Improper repair/diagnosis
 - Improper maintenance
 - Normal wear and tear
 - Misuse
 - Abuse
 - Accident
 - Misapplication
 - Negligence
4. Failures caused by any external cause or act of God, such as collision, theft, vandalism, riot or wars, nuclear holocaust, fire, freezing, lightning, earthquake, windstorm, hail, volcanic eruption, water or flood, tornado or hurricane.
5. Products and/or part(s) that are modified or altered in a manner not authorized by Generac in writing.
6. Any incidental, consequential or indirect damages caused by defects in materials or workmanship, or any delay in repair or replacement of the defective part(s).
7. Failure due to misapplication.
8. Telephone, telegraph, teletype or other communication expenses.
9. Living or travel expenses of person(s) performing service, except as specifically included within the terms of a specific unit warranty period.
10. Rental equipment used while warranty repairs are being performed.
11. Freight costs for replacement part(s).
12. Labor charges.

THIS WARRANTY IS IN PLACE OF ALL OTHER WARRANTIES, EXPRESSED OR IMPLIED. SPECIFICALLY, GENERAC MAKES NO OTHER WARRANTIES AS TO THE MERCHANTABILITY OR FITNESS FOR A PARTICULAR PURPOSE. Any implied warranties which are allowed by law, shall be limited in duration to the terms of the express warranty provided herein. Some states do not allow limitations on how long an implied warranty lasts, so the above limitation may not apply to you. GENERAC'S ONLY LIABILITY SHALL BE THE REPAIR OR REPLACEMENT OF PART(S) AS STATED ABOVE. IN NO EVENT SHALL GENERAC BE LIABLE FOR ANY INCIDENTAL OR CONSEQUENTIAL DAMAGES, EVEN IF SUCH DAMAGES ARE A DIRECT RESULT OF GENERAC'S NEGLIGENCE.

Some states do not allow the exclusion or limitation of incidental or consequential damages, so the above limitation may not apply to you. This warranty gives you specific legal rights. You may also have other rights from state to state.

GENERAC POWER SYSTEMS, INC.

345 W29290 Hwy. 59 • Waukesha, WI 53189 • Ph: (888) GENERAC (436-3722) • Fax: (262) 544-4851
To locate the nearest Authorized Dealer visit our website at www.generac.com

Part No. 0H1608

Rev. C (09/12)

PROCEDURE FOR FILING CLAIM:

If you encounter a problem with your remote monitor, please review the installation and programming sections to ensure that the guidelines were followed. If a problem still exists, please contact 888-GENERAC (888-436-3722) for assistance and have your proof of purchase available for verification. After speaking with a customer service representative, a decision will be made if a replacement remote monitor will be sent out to you free of charge. Generac Power Systems recommends that the installation of the remote monitor be performed by a qualified installer/dealer.

NOTE: Labor and travel charges ARE NOT allowed under this factory warranty.