

MITSUBISHI GENERATOR

MGC1101 Owner's Manual

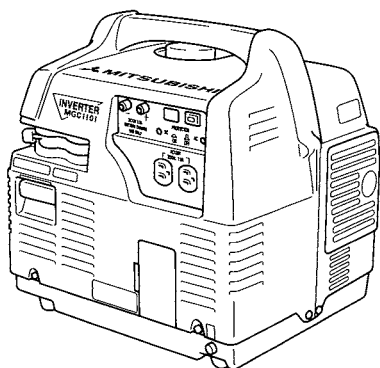

OWNER'S MANUAL

ENGLISH

MANUAL D'UTILISATION

FRANÇAIS

MANUAL DEL PROPIETARIO

ESPAÑOL

使用说明书

CHINESE



**Before starting this generator,
read and understand this Owner's Manual.**

**Veuillez lire et bien comprendre le manuel de
l'utilisateur avant de démarrer le générateur.**

**Antes arrancar este generador, lea y entienda
este Manual del propietario.**

启动发电机之前，必须阅读和掌握该用户使用手册



A list of errata – KN55045AA

The first paragraph of "California, United States and Canada Emission Control Defects Warranty Statement" clause	
(Current)	(New)
CARB, U.S.EPA and MHI are pleased to explain the Emission Control System Warranty on your model year 2000 and later	CARB, U.S.EPA and MHI are pleased to explain the Emission Control System Warranty on your model year 2006 and later
The second paragraph of "California, United States and Canada Emission Control Defects Warranty Statement" clause	
(Current)	(New)
Your emission control system includes parts such as the carburetor, air cleaner, ignition system, muffler and catalytic converter. Also included may be connectors and	Your emission control system includes parts such as the carburetor, air cleaner, ignition system, muffler and catalytic converter. Also included may be hoses, connectors and
The third paragraph of "Owner's Warranty Responsibilities" clause	
(Current)	(New)
You are responsible for presenting your small off-road engine to an Authorized service dealer of lawn and garden equipment manufacture to whom MHI would sell engines	You are responsible for presenting your small off-road engine to an Authorized service dealer of equipment manufacture to whom MHI would sell engines

The third paragraph of 1.a	
(Current)	(New)
• Fuel pump, applicable	• Fuel pump, if applicable
The first paragraph of 1.d	
(Current)	(New)
d. Catalyst system	d. Catalyst system
• Exhaust manifold, if applicable	• Catalytic converter, if applicable
	• Exhaust manifold, if applicable
The first paragraph of 3	
(Current)	(New)
3. No charge	3. No charge
Repair or replacement of any warranted part will be performed at no charge to the owner, including diagnostic labor which leads to the determination that a warranted part is defective, if the diagnostic work is performed at an Authorized service dealer of <u>Lawn and garden</u> equipment manufacture to whom MHI would sell engine.	Repair or replacement of any warranted part will be performed at no charge to the owner, including diagnostic labor which leads to the determination that a warranted part is defective, if the diagnostic work is performed at an Authorized service dealer of equipment manufacture to whom MHI would sell engine. For emissions warranty service, contact your nearest Authorized service dealer of equipment manufacture to whom MHI would sell engine.

Emission System Warranty

**MITSUBISHI HEAVY INDUSTRIES, LTD. (MHI)
and the California Air Resources Board (CARB)
and the United States Environmental Protection Agency (U.S.EPA)
Emission Control System Warranty Statement
(Owner's Direct Warranty Rights and Obligations)**

Emission control warranty coverage is applicable to certified engines purchased in California in 1995 and thereafter, which are used in California, and to certified model year 1997 and later engines which are purchased and used elsewhere in the United States (and after January 1, 2001 in Canada).

California, United States and Canada Emission Control Defects Warranty Statement

CARB, U.S. EPA and MHI are pleased to explain the Emission Control System Warranty on your model year 2000 and later "small off-road engine (SORE)". In California, new small off-road engines must be designed, built and equipped to meet the State's stringent antismog standards. Elsewhere in the United States, new non-road, spark-ignition engines certified for model year 1997 and later, must meet similar standards set forth by the U.S. EPA. MHI must warrant the emission control system on your engine for the periods of time listed below, provided there has been no abuse, neglect or improper maintenance of your small off-road engine.

Your emission control system includes parts such as the carburetor, air cleaner, ignition system, muffler and catalytic converter. Also included may be connectors and other emission related assemblies.

Where a warrantable condition exists, MHI will repair your utility or lawn and garden equipment engine at no cost to you including diagnosis, parts and labor.

MITSUBISHI HEAVY INDUSTRIES, LTD. Emission Control Defects Warranty Coverage

Small off-road engines are warranted relative to emission control parts defects for a period of two years, subject to provisions set forth below. If any covered part on your engine is defective, the part will be repaired or replaced by MHI.

Owner's Warranty Responsibilities

As the small off-road engine owner, you are responsible for the performance of the required maintenance listed in your Owner's Manual. MHI recommends that you retain all your receipts covering maintenance on your small off-road engine, but MHI cannot deny warranty solely for the lack of receipts or for your failure to ensure the performance of all scheduled maintenance.

As the small off-road engine owner, you should however be aware that MHI may deny you warranty coverage if your small off-road engine or a part has failed due to abuse, neglect, improper maintenance or unapproved modifications.

You are responsible for presenting your small off-road engine to an Authorized service dealer of lawn and garden equipment manufacture to whom MHI would sell engines as soon as a problem exists. The undisputed warranty repairs should be completed in a reasonable amount of time, not to exceed 30 days. If you

have any question regarding your warranty rights and responsibilities, you should contact the Mitsubishi distributor service department at 1-219-764-5407

The emission warranty is a defects warranty. Defects are judged on normal engine performance.

The warranty is not related to an in-use emission test.

MITSUBISHI HEAVY INDUSTRIES, LTD. Emission Control Defects Warranty Provisions

The following are specific provisions relative to your Emission Control Defects Warranty Coverage. It is in addition to the MHI engine warranty for non-regulated engines found in the Owner's Manual.

1. Warranted parts

Coverage under this warranty extends only to the parts listed below (the emission control system parts) to the extent these parts were present on the engine purchased.

- a. Fuel Metering System
 - Carburetor and Internal parts
 - Cold start enrichment system (soft choke)
 - Fuel Pump, applicable
- b. Air Induction System
 - Air Cleaner
- c. Ignition System
 - Spark plug(s)
 - Magneto ignition system
- d. Catalyst system
 - Exhaust manifold, if applicable
- e. Miscellaneous Items Used in Above Systems
 - Hoses, connectors, and assemblies.

2. Length of coverage

MHI warrants to the initial owner and each subsequent purchaser that the Warranted Parts shall be free from defects in materials and workmanship which causes the failure of the Warranted parts for a period of two years from the date the engine is delivered to a retail purchaser.

3. No charge

Repair or replacement of any Warranted Part will be performed at no charge to the owner, including diagnostic labor which leads to the determination that a Warranted Part is defective, if the diagnostic work is performed at an Authorized service dealer of lawn and garden equipment manufacture to whom MHI would sell engines.

4. Claims and coverage exclusions

Warranty claims shall be filed in accordance with the provisions of the MHI engine warranty policy. Warranty coverage shall be excluded for failures of Warranted Parts which are not original MHI parts or because of abuse, neglect or improper maintenance as set forth in the MHI engine warranty policy. MHI is not liable to cover failures of warranted parts caused by the use of add-on, non-original, or modified parts.

5. Maintenance

Any warranted part which is not scheduled for replacement as required maintenance or which is scheduled only for regular inspection to the effect of "Repair or replace as necessary" shall be warranted as to defects for the warranty period. Any warranted part which is scheduled for replacement as required maintenance shall be warranted as to defects only for the period of time up to the first scheduled replacement for that part. Any replacement part that is equivalent in performance and durability may be used in the performance of any maintenance or repairs. The owner is responsible for the performance of all required maintenance, as defined in the MHI owner's manual.

6. Consequential coverage

Coverage hereunder shall extend to the failure of any engine components caused by the failure of any warranted part still under warranty.

CAUTIONARY NOTICE

The customer must know that the generator has potential danger.

MHI is not liable for any damage or injury arising from an individual's failure to follow instructions contained in this manual, or his failure to exercise due care and caution in the installation, operation, inspection, and service of the generator.

(California, U.S.A.-Proposition 65 warning statement)

WARNING

The engine exhaust from this product contains chemicals known to the State of California to cause cancer, birth defects or other reproductive harm.

CONTENTS

	Page
INTRODUCTION	1
FOR SAFETY OPERATION	3
MAJOR PRINCIPLES	5
IMPORTANT LABEL	6
NAME OF EACH PART	8
HANDLING EACH PART	9
PRE-OPERATION CHECKS	13
	ENGLISH
CORRECT OPERATION PROCEDURES	16
EASY INSPECTION AND MAINTENANCE ..	21
PERIODIC INSPECTION AND	24
PREPARATION FOR STORAGE	
TROUBLESHOOTING	25
WIRING DIAGRAM	26

INTRODUCTION

Thank you for purchasing a Mitsubishi's generator.

This manual describes the correct handling method and simple inspection and maintenance procedures of the generator.

Wrong handling will cause serious injuries as well as failures.

For safe operation and achievement of full performance of the generator, read through this manual before starting operation, and carry the manual during operation.

Correct handling and items necessary for the inspection and maintenance are described with the following symbols in this operation manual.

WARNING

Negligence of description may cause deaths or serious injuries.

CAUTION

Negligence of description may cause injuries or material losses.

NOTE

Correct operation methods and important inspection or maintenance points are described. Negligence of description may cause damage to the generator or other devices.

- Part of drawings and description in this manual may be different from the actual machine due to specification changes.
- Read the warranty carefully and check that the date of purchase and dealer are written.
- Keep this manual in a safe place and refer to it whenever uncertainties or trouble arise. When reselling or giving the generator to a third party, have this manual delivered together with the machine.

FOR SAFE OPERATION-1

- Before starting operation, maintenance or inspection, read this operation manual and all the labels on the generator for correct operation. Be familiar with knowledge about the generator, safety information and all the precautions before starting operation.

WARNING

- Do not stain or peel off warning labels.
- Danger of intoxication by exhaust gas. Do not operate in a poorly ventilated area.
The exhaust gas contains toxic matter. Do not operate the generator in poorly ventilated areas such as indoors or a warehouse, tunnel, well, ship hold, tank and manhole or places where ventilation is blocked by buildings or shields.
- Danger of fire. Do not enclose the generator or cover it in a box.
- Danger of burns. The muffler is very hot during operation and immediately after operation. Do not touch the muffler or protector around the muffler directly.
- Danger of fire. Keep lit tobacco or other sources of fire away during fuel supply.
- Danger of electric shock and fire. Do not connect to commercial power supply wiring. If connected, failure of electric appliances or generator, fire or injuries will be caused.
- Danger of electric shock. Do not operate the generator with wet hands.
- Danger of electric shock. Do not insert pins, wires or other metallic matters into the outlet.
- Danger of electric shock or injuries. Do not perform inspection or maintenance during operation.
- Danger of electric shock or injuries. Do not remodel or operate the generator without some parts.
- When lending the generator to someone, hand over this operation manual together with it without fail.
- Danger of intoxication by exhaust gas or fire. Keep the exhaust port 1 meter (3.3 ft) or more away from a building or another equipment.
- Danger of fire. Supply fuel in a well ventilated place after stopping the engine. The fuel can ignite and explode. Take sufficient care for the handling. Check that there is no gasoline leaks before starting the engine.
- Danger of fire. Do not spill the fuel. Carefully wipe off spilled fuel and wait until it is dried before starting the engine.
- If the fuel is splashed on your skin or clothes, immediately wash using soap and water, and change the clothes.
- If the fuel is swallowed or fuel vapor is inhaled, or the fuel enters the eye, get medical attention immediately.

FOR SAFE OPERATION-2

CAUTION

- Danger of injuries. Do not operate the generator on an inclined floor.
- Danger of injuries. Do not move the generator during operation.
- Danger of injuries. Do not reach rods or wires toward the rotating parts of the generator.
- Danger of electric shock. Keep away from the spark plug during operation.
- Danger of electric shock. Do not operate the generator in rain or snow.
- Danger of electric shock or injuries. Do not let a child operate the generator.
- Danger of electric shock or injuries. Do not connect electric appliances before starting the engine.
- Danger of electric shock. Connect a grounding wire to the grounding terminal of the generator.
- Danger of fire. Do not place dangerous matters (oil and grease, celluloid, explosives, etc.) and flammable matters (hay, straw dust, paper dust, wood dust or other flammable matters).
- Danger of fire. Do not operate the generator at an overload exceeding the rated output.
- Danger of fire. Observe the fuel specification and rated capacity when operating the generator.
- When transporting the generator on a truck or the like, fix it securely to prevent it from falling.
- Do not fail to perform pre-operation checks and periodic inspection.
- If abnormal noise, malodor, excessive vibration or other abnormalities are found during operation, immediately stop the engine and have it inspected by the dealer or our service outlet.

When disposing of the generator or discharging waste oil or the like, consult the dealer or our service outlet for environmental preservation.

MAJOR PRINCIPLES

Item	Name	MGC1101	
Generator	Model	Rotating multi-pole field magnet type single-phase AC inverter generator	
	Excitation method	Self excitation	
	Voltage regulation method	Inverter method	
	Alternating current	Rated frequency	50Hz/60Hz
		Max. output	1050A
		Rated output	950VA
		Rated voltage	110V, 120V, 220V, 230V, 240V
		Power factor	1.0
	Direct current	Rated output	100W
		Rated voltage	12V
		Rated current	8.3A
	Output terminal	Alternating current	Grounded outlets
		Direct current	Terminal
		AC/DC overcurrent protector	Circuit protector
Engine	Name	GM82PN	
	Type	Air-cooled 4-cycle OHV gasoline engine	
	Total displacement	80cm ³ (4.9 cu in)	
	Max. output	1.8kW (2.4PS)	
	Fuel	Non-leaded gasoline for automobiles	
	Fuel tank capacity (red level)	3.8 L (1.0 USgal)	
	Rated continuous operation hours (red level)	About 5 hours	
	Lubricant	API classification class SD or better (10W-30)	
	Lubricant capacity	0.4 L (0.11 USgal)	
	Ignition method	Transistor type magnet ignition	
	Starting method	Recoil method	
Others	Dimensions (overall length × overall width × overall height)	400 × 330 × 390mm (15.7 × 13.0×15.4 in)	
	Dry weight	20kg (44lb)	

IMPORTANT LABELS-1

For safe operation of the generator, read through the labels affixed on the main body.

NOTE

Keep the labels clean. If any label is stained or peeled off, contact the dealer and replace it with new one.

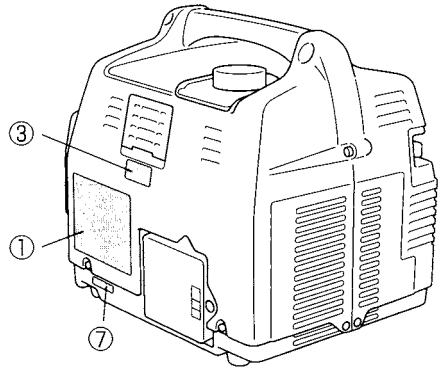
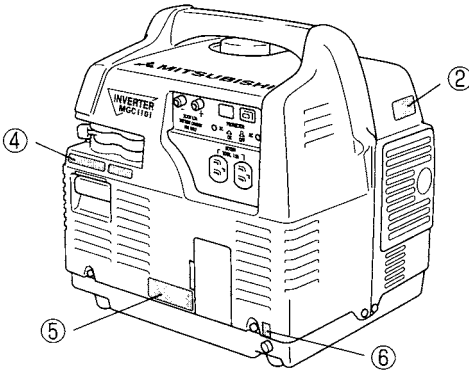

⚠ WARNING ⚠ CAUTION Label

①

⚠ DANGER	
	<p>Exhaust gas</p> <ul style="list-style-type: none"> Exhaust gas contains poisonous carbon monoxide. Do not use in poorly ventilated area.
	<p>Electric shock</p> <ul style="list-style-type: none"> The operator may suffer severe electric shock. Do not touch with wet hands.
⚠ WARNING	
	<p>No fire</p> <ul style="list-style-type: none"> Potential danger of explosion or fire.
	<p>Do not operate in rain or snow</p> <ul style="list-style-type: none"> Stop engine during fuel supply. Keep flammable things away.
	<p>Do not connect to a household circuit</p> <ul style="list-style-type: none"> Be careful not to spill fuel during refueling.
AC	
VOLTAGE	120V
FREQUENCY	60Hz
RATED OUTPUT	950VA
MAX. OUTPUT	1050VA
CURRENT	7.9A
POWER FACTOR	1.0
PHASE	1ø
NEUTRAL BONDED TO FRAME.	
DC	
VOLTAGE	120V
CURRENT	8.3A
FUEL	
NONLEADED GASOLINE	

IMPORTANT LABELS-2

②

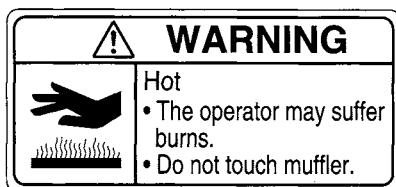

③

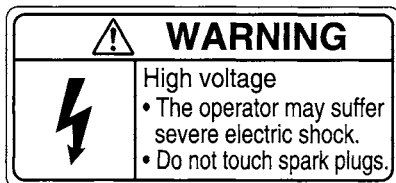

Other labels

④ Handling procedure

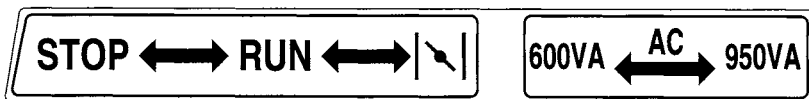

⑤

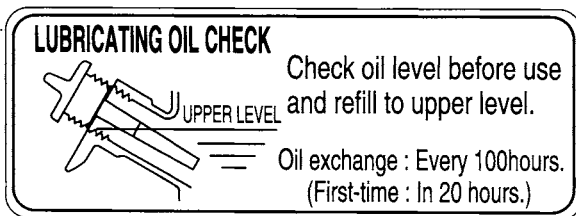

⑥ Grounding



⑦ Model and serial number

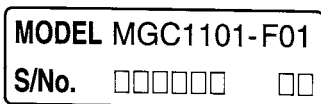

NAME OF EACH PART

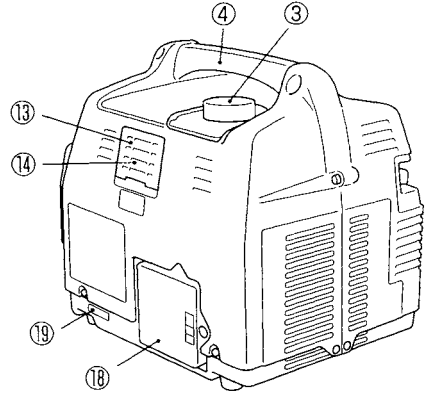
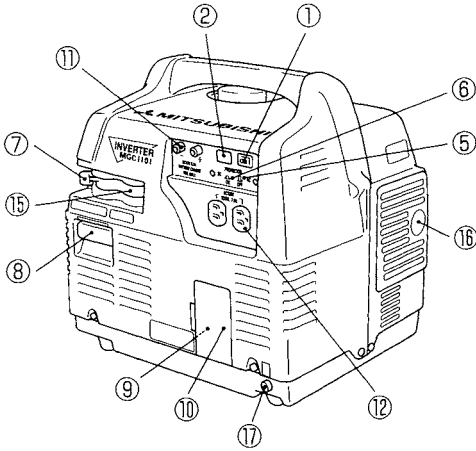

- ① Oil sensor lamp
- ② Pilot lamp
- ③ Fuel tank cap
- ④ Handle
- ⑤ AC protector
- ⑥ DC protector
- ⑦ Engine switch
- ⑧ Recoil starter grip
- ⑨ Oil filler cap
- ⑩ Oil maintenance cover

- ⑪ DC terminal
- ⑫ AC outlet
- ⑬ Spark plug maintenance cover
- ⑭ Spark plug
- ⑮ AC outlet selection switch
- ⑯ Exhaust port
- ⑰ Grounding terminal
- ⑱ Air cleaner
- ⑲ Model and serial number label

HANDLING EACH PART-1

● Engine switch

The engine switch controls the ignition and fuel systems to start or stop the engine.

STOP Lever position for stopping the engine or for storage. The gasoline does not flow.

RUN Lever position for operating the engine. Place the switch in this position when the engine is warm.

 Lever position for starting the engine. The choke functions.

Operation of the engine switch is interlocked with the operation of the fuel cock and choke.

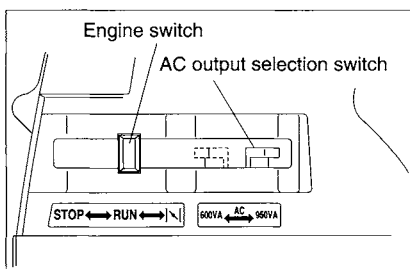

● AC output selection switch

The output of the generator can be decreased with a small load of connected electric appliances to reduce noise and fuel cost.

950VA For rated output 950VA

600VA To reduce the output to 600VA

HANDLING EACH PART-2

- **Oil sensor lamp**

The lamp gives a warning for a low engine oil level.

When the engine oil level is reduced below the rated level, the oil sensor lamp lights up and the engine is automatically stopped. If the engine oil is below the rated level, the sensor lamp lights up and the engine does not start even if the recoil starter handle is pulled.

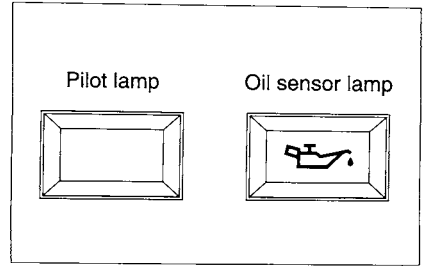

NOTE

If the generator is inclined, the oil sensor functions to stop the engine. Operate the engine on a level surface.

- **Pilot lamp**

After engine starts and electricity is generated, a green lamp lights up.

- **AC outlet**

AC outlet for electric appliances. Two outlets are installed.

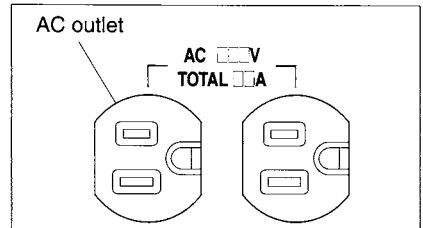

- **DC terminal**

DC terminal for charging a battery.

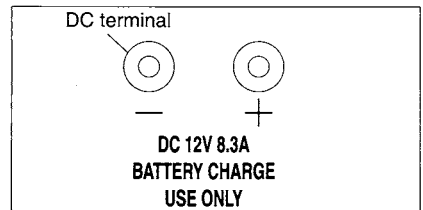

- **Grounding terminal**

Grounding terminal for prevention of electric shock.

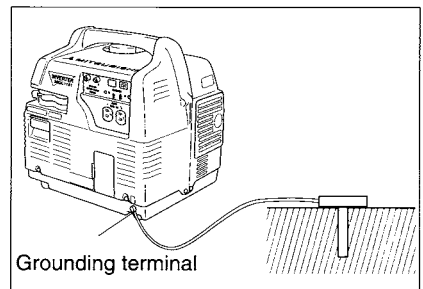

HANDLING EACH PART-3

● AC protector

The AC protector shuts off the circuit to protect the generator if the operating range is exceeded or there is a fault in the connected appliance.

ON : The power is supplied.

OFF: The circuit is shut off and the power is not supplied.

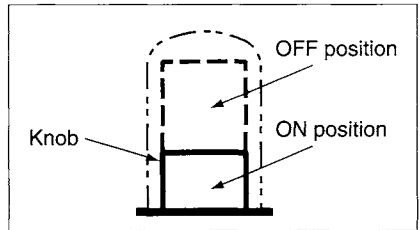
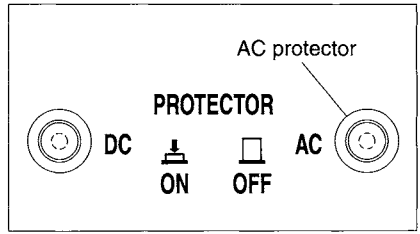

⚠ CAUTION

If the protector has functioned to shut off during operation of the generator, check the following items and, after removing the cause of the trouble, turn the knob ON again.

- Check the connected appliances for any fault.
- Check if too much power is output.

● DC protector

The DC protector shuts off the circuit to protect the generator if the operating range is exceeded or there is a fault in the battery.

ON : The power is supplied.

OFF: The circuit is shut off and the power is not supplied.

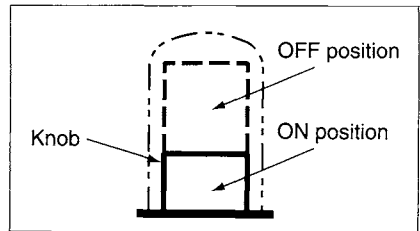
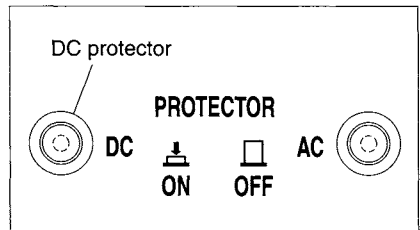

⚠ CAUTION

If the protector has functioned to shut off during operation of the generator, check the following items and, after removing the cause of the trouble, turn the knob ON again.

- Check the battery for any fault.
- Check if too much power is output.

HANDLING EACH PART-4

- **Recoil starter grip**

Used to start the engine.

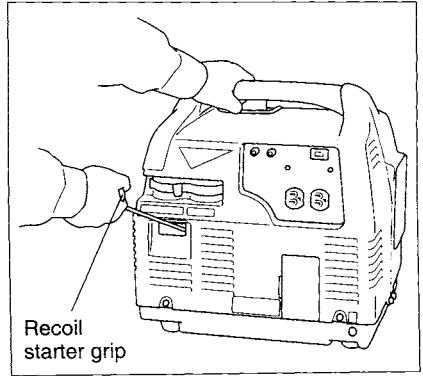

- **Spark plug maintenance cover**

Removed for inspection or cleaning of the spark plug.

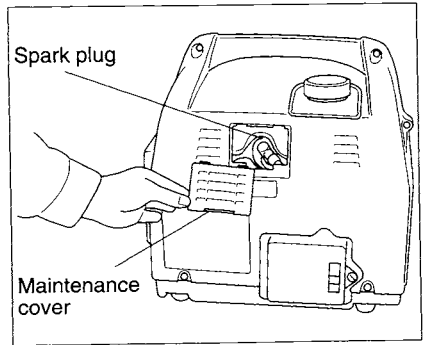

- **Oil maintenance cover**

Removed if the engine oil level is inspected or engine oil is supplied or replaced.

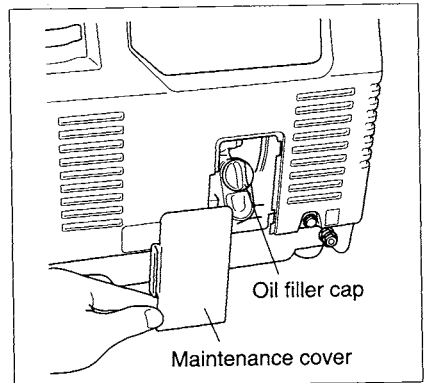

PRE-OPERATION CHECKS-1

⚠ CAUTION

- Negligence of pre-operation checks may cause accidents and serious damage to the generator.
- To assure safety, always keep the generator in a good condition.
- To inspect the engine, place the generator on a level surface and stop the engine.

● Inspecting or supplying fuel

Remove the fuel tank cap and inspect the fuel level. If the fuel level is low, supply fuel so that the filling limit position (red level) is not exceeded.

Fuel tank capacity:

3.8 L (1.0 USgal) (up to red level)

Fuel: Non-leaded gasoline (gasoline for automobiles)

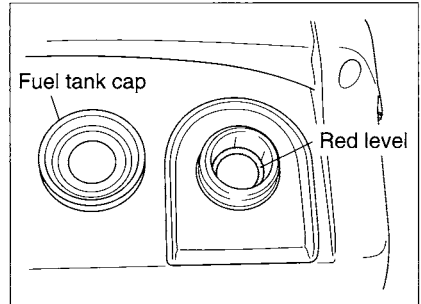

NOTE

- Supply fuel slowly.
- Supply fuel at the earliest instance before the tank becomes empty.

⚠ WARNING

The fuel gasoline poses a danger of ignition and explosion. Observe the following items without fail.

- Stop the engine and supply fuel in a well ventilated area.
- Keep flammable things such as lit tobacco away.
- Do not spill the fuel. Wipe spilled fuel immediately using cloth or the like.
- Securely tighten the fuel tank cap.

⚠ CAUTION

- Be careful to avoid entry of water, snow or other types of moisture and dust and foreign matter in the tank during fuel supply. Do not remove the fuel filter during fuel supply.
- Do not supply fuel beyond the standard level (red level on filter).

PRE-OPERATION CHECKS-2

● Inspecting or supplying engine oil

Remove the oil maintenance cover and oil filler cap and inspect if the engine oil is at the upper level (standard level) on the oil level gauge.

If the level is low, supply new oil to the standard level.

Oil amount : 0.4 L (0.11 USgal)

Recommended oil: Engine oil
 API classification class
 SD or better
 SAE10W-30

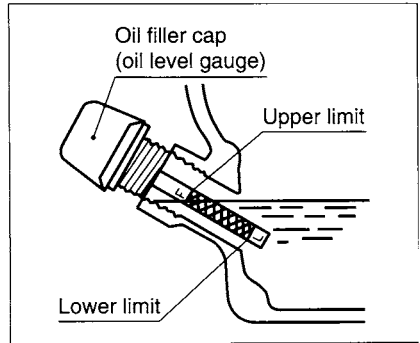
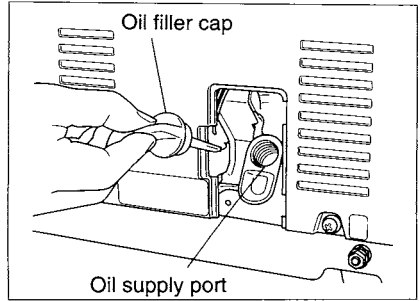

⚠ CAUTION

- Engine oil is not supplied when the engine is shipped from the factory. Supply engine oil before starting the engine.

NOTE

- Tighten the oil filler cap securely.
- Be sure to wipe off spilled engine oil.
- Use API classification class SD or better SAE 5W or 5W-30 oil at cold temperatures.

SAE oil viscosity table

Single grade	5W						
	10W						
	20W						
	#20						
	#30						
Multi grade							
Outside temperature	-20	-10	0	10	20	30	40°C
	-4	14	32	50	68	86	104°F

PRE-OPERATION CHECKS-3

● Inspecting the air cleaner

Remove the air cleaner cover and inspect the element for dirt. Clean the element if it is dirty. (Refer to “Easy inspection and maintenance” for the cleaning method.)

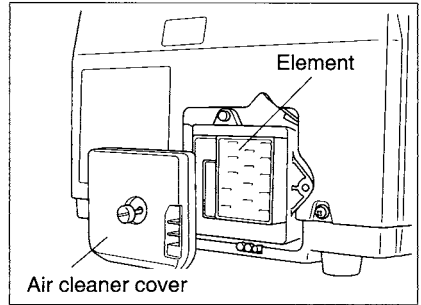

NOTE

- If the element or air cleaner cover is improperly installed or no element is installed, the engine performance and durability are seriously decreased.
- Securely install the cover and element.

● Inspection of other parts

Check the controls for the correct function and check the engine for proper operation.

- Operation state of engine switch and output selection switch
- Operation of recoil starter and damage of starter rope
- Starting performance, abnormal noise and color of exhaust gas of engine
- Damage of AC outlet and DC terminal

● Inspection of periphery of generator

Inspect the periphery of the generator for safe operation.

- Check if there is fire, flammable matter or dangerous matter around the engine.
- Check if the engine is 1 meter (3.3 ft) or more away from a nearby building or other equipment.
- Check if the exhaust port is in a wide well ventilated area.
- Check if the generator is installed on a flat and level surface.

CORRECT OPERATION PROCEDURES-1

• Starting the engine

⚠ CAUTION

Do not connect electric appliances before starting the engine.

1. Check the fuel and oil levels.
2. Place the engine switch in the  (starting) position.
When the engine is warm, place the switch in the RUN position.
3. Lightly pull the recoil starter grip until resistance is felt.
Then pull swiftly to start the engine.

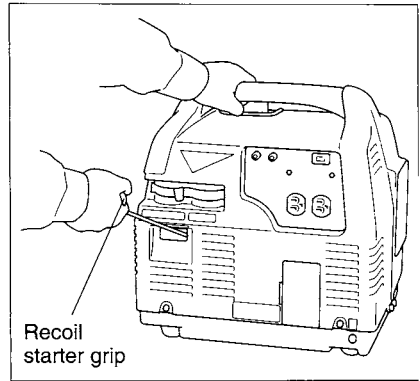
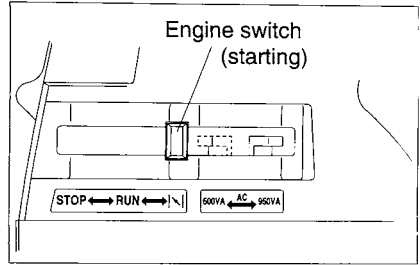

⚠ CAUTION

Slowly return the recoil starter grip.

NOTE

If the engine does not start while the recoil starter grip is pulled several times, place the engine switch in the RUN position and pull the recoil starter grip.

4. After the engine speed has become stable, place the engine switch in the RUN position.
5. Warm up the engine for a while.

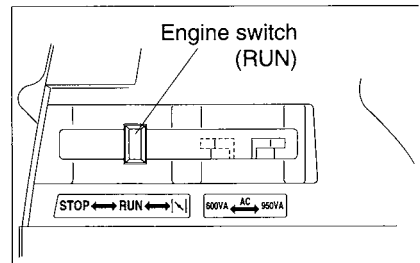

CORRECT OPERATION PROCEDURES-2

• Using AC power

⚠ WARNING

Never connect to the commercial power supply wiring. Otherwise fire, injuries, or damage of the generator or electric appliances will be caused.

1. Connect the grounding terminal.

⚠ CAUTION

To prevent electric shock and damage of the generator, connect the grounding terminal of the generator to the ground.

2. Start the engine.
3. Check that the pilot lamp is lit.
4. Insert the plug of the electric appliance to the AC outlet.

NOTE

Be sure to check that the appliance is turned off before connecting the plug.

⚠ CAUTION

- Securely insert the plug to avoid poor contact, disconnection or loose connection.
- Use a 3-prong plug having a grounding terminal shown in the figure.

5. Turn the electric appliance on.

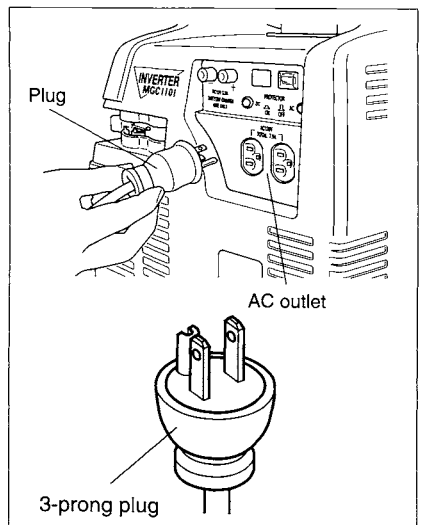
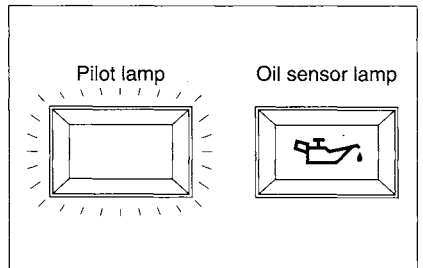
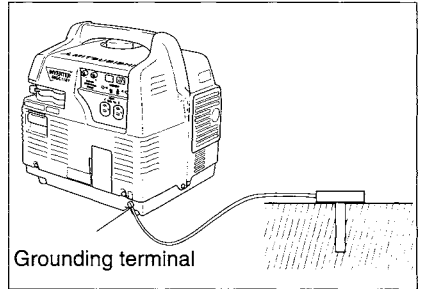

CORRECT OPERATION PROCEDURES-3

• Using DC power

The DC power is exclusively for a 12V battery. Do not use the power for other than charging.

⚠ WARNING

- Place the battery in a well ventilated area and keep fire away. Be careful to avoid sparks. The battery generates ignitable gases and there is a danger of explosion.
- The battery electrolyte (diluted sulfuric acid) entering the eye or attaching on the skin or clothes may cause loss of sight or injuries. Take sufficient care for the handling. If it attaches, immediately flush with a large amount of water and get medical attention.
- When disconnecting the cable from the battery, disconnect the \ominus cable first. On contrary, connect the \oplus cable first when connecting. If the order is wrong, a short-circuit may be caused.

1. Remove the cables and tubes from the battery.
2. Measure the specific gravity of the battery electrolyte and determine the charging time.
 - Remove the electrolyte supply caps of the battery and check the electrolyte level. If the level is low, supply distilled water to the upper limit.
 - Measure the specific gravity of the battery electrolyte and determine the charging time in the table on the right. The specific gravity of a fully charged electrolyte is 1.26 to 1.28. The charging time varies according to the type of the battery and discharge conditions. Check every hour.
3. Connect the charging cable between the DC terminals and battery terminals.

Relationship between specific gravity and charging time

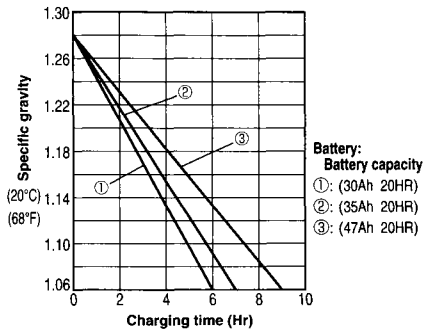

⚠ CAUTION

- Use the special charging cable (option) for connection with the battery.
- Do not make a mistake in the \oplus and \ominus polarities when connecting the charging cable. Wrong connection may cause a short circuit or failure of the generator or battery.

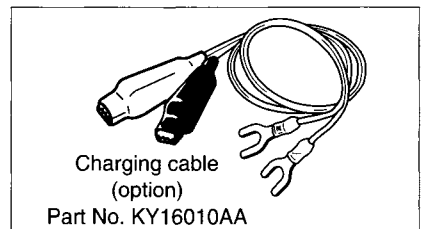
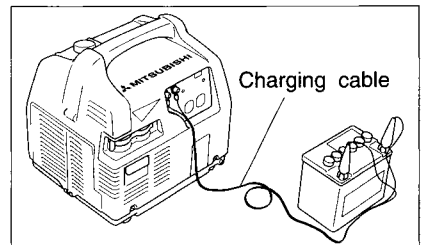



4. Adjust the output selection switch of the generator to 950VA and start the engine to start charging.

CORRECT OPERATION PROCEDURES-4

● **Operating range of AC and DC power**

Use the AC or DC power in the following operating range for electric appliances. Check the power consumption (wattage) of the electric appliance to be connected.

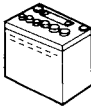
	Connected electric appliance	Operating range		Remarks
		Setting of output selection switch		
		950VA	600VA	
Alternating current (AC)	Lighting, heater, TV set, radio, etc. 	Up to 950W	Up to 600W	<ul style="list-style-type: none"> ● If the DC power is used simultaneously, select 950VA at the output selection switch. Subtract 100W from the operating range of the AC electric appliance shown to the left.
	Motor-driven tools 	Up to 760W	Up to 480W	
	General motors 	Up to 430W	Up to 270W	
Direct current (DC)	Battery 	Up to 12V-8.3A	—	

⚠ CAUTION

- Do not operate the generator at an overload where the total load of electric appliances exceeds the operating range. Otherwise the generator will be broken.
- Part of motor-driven tools or generator motors may not operate even within the operating range if the starting current is large or due to some conditions of the electric appliance.

NOTE

If the operating range is exceeded or there is a fault in the electric appliance, the AC protector turns off the circuit.

CORRECT OPERATION PROCEDURES-5

● Stopping the engine

1. Turn the electric appliance off.

2. Disconnect the plug of the electric appliance from the outlet.

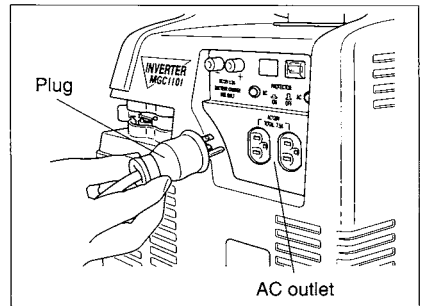

3. Place the engine switch in the STOP position.

NOTE

The fuel cock is closed when the engine switch is placed in the STOP position.

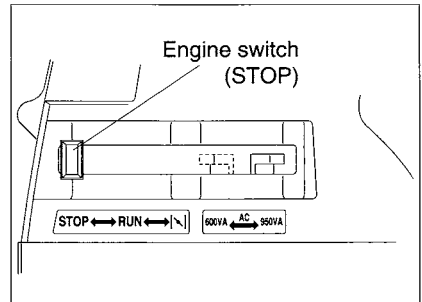

EASY INSPECTION AND MAINTENANCE-1

● Replacement of engine oil

1. Start the engine and warm up for two to three minutes.
2. Stop the engine.
3. Remove the oil maintenance cover.
4. Remove the oil filler cap.

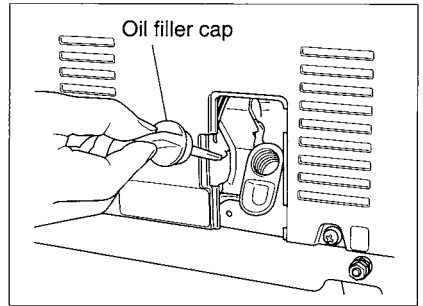

5. Tilt the generator to drain engine oil.

NOTE

Change after 20 hours for the first time and at every 100 hours thereafter.

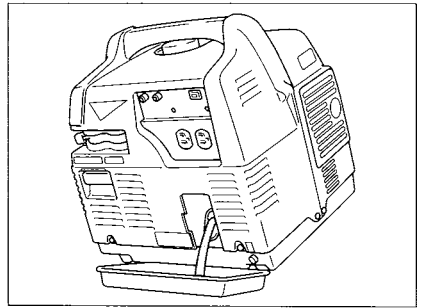

6. Supply new oil to the upper limit (standard level) on the oil level gauge.

Oil amount: 0.4 L (0.11 USgal)

Oil : Engine oil
API classification class SD
or better
SAE 10W-30

NOTE

- Place the generator on a level surface before supplying engine oil.
- Be sure to wipe off spilled engine oil.

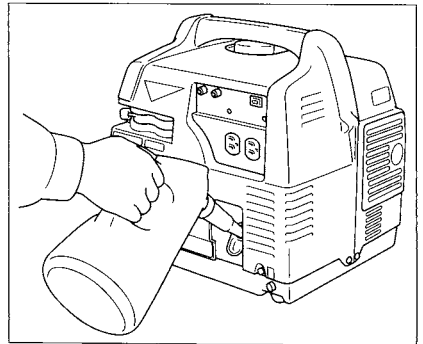

7. Tighten the oil filler cap.
8. Install the oil maintenance cover.

EASY INSPECTION AND MAINTENANCE-2

● Cleaning of air cleaner element

Periodically clean the air cleaner element. A dirty air cleaner or a clogged element will cause poor output and a larger fuel consumption.

1. Remove the air cleaner cover and take out the element.

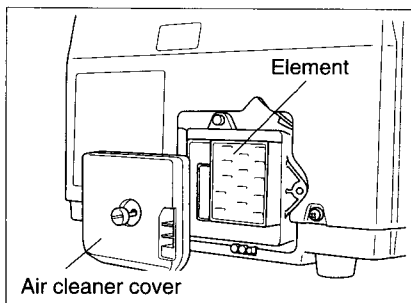

2. Wash the element in washing oil and dry, then immerse it in clean engine oil and squeeze.

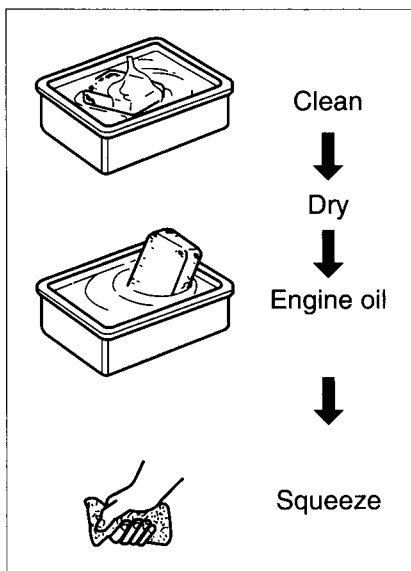

⚠ WARNING

- The washing oil is ignitable. Keep it away from fire. Otherwise fire will be caused.
- Wash in a well ventilated area.

3. Install the element in the case and install the air cleaner cover.

NOTE

- An improper installation of the element or air cleaner cover or failure to install the element will deteriorate the engine performance and durability severely. Securely install the cover and element.
- Periodically clean at every 50 operation hours. Clean more frequently after operation in an area with much dust.

EASY INSPECTION AND MAINTENANCE-3

● Inspection and cleaning of spark plug

A dirty or worn spark plug electrode will cause poor performance of the engine. Periodically inspect and/or clean.

⚠ CAUTION

The engine, muffler, spark plug and other parts are very hot immediately after the engine is stopped. Wait until it cools down before starting inspection, to avoid burns.

1. Remove the spark plug maintenance cover and remove the spark plug cap.
2. Using the accessory plug wrench, remove the spark plug.
3. Inspect the spark plug for the burning condition. A light brown color indicates regular operating condition. If the plug is blackish or whitish, inspect the air cleaner.
4. Remove dirt (carbon) from the electrode and its periphery.
5. Inspect the electrode gap.

Designated spark plug: NGK BPR6HS

Electrode gap: 0.6 ~ 0.7mm
(0.240 ~ .028in)

Inspection and cleaning interval:
At every 100 hours

6. Install the spark plug.

NOTE

- To install the spark plug, tighten with fingers to the full force, then use the plug wrench to avoid giving damage to the thread, and securely tighten.
- Do not use a spark plug other than the designated one, or failure of the engine may be caused.

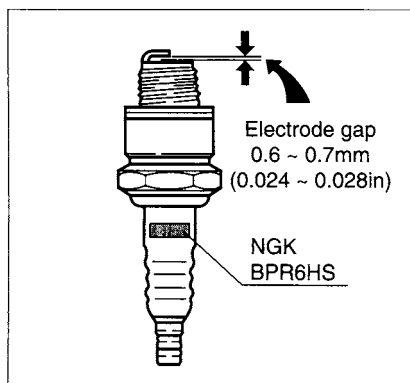
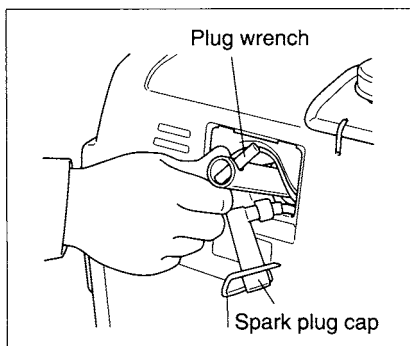

PERIODIC INSPECTION AND PREPARATION FOR STORAGE

● Periodic inspection

Periodically inspect the engine to prevent failure and accidents of the generator and to insure safe operation.

⚠ WARNING

- The engine, muffler and periphery are very hot immediately after the engine is stopped. Wait until the engine cools down before starting inspection, to avoid burns.
- The exhaust gas contains carbon monoxide and other harmful contents. Do not start the engine in a closed room or in a poorly ventilated area for inspection.

Inspection items and timing

Inspection and maintenance item		Inspection interval				
		At start of operation	At first 20 hours	At every 3 months or 50 hours	At every 6 months or 100 hours	At every year or 300 hours
Fuel	Inspect leakage and amount	○				
Fuel tank filter	Clean			○		
Fuel strainer	Replace					●
Fuel pipe	Inspect cracks					●
Engine oil	Inspect leakage and amount	○				
	Replace		○		○	
Air cleaner element	Inspect	○				
	Clean			○		
Spark plug	Inspect and clean				○	
Recoil starter	Function and breakage of rope	○				
Switches, and electrical equipment on operation panel	Function and breakage	○				
Tightened parts at each part of main body	Inspect and retighten				●	
Cylinder head	Remove carbon					●
Valve clearance	Inspect and adjust					●

Contact the dealer or our service outlet for inspection and maintenance of the items marked with solid black circle ●.

● Preparation for storage

Before stopping operation for an extended period or storing for a long time, perform the following maintenance.

- Clean each part using clean dry cloth.
- Change the engine oil.
- Clean the air cleaner.
- Drain gasoline from the carburetor.
After draining gasoline from the fuel tank, drain fuel from the drain screw of the carburetor.
- Pull the recoil starter until resistance is felt.

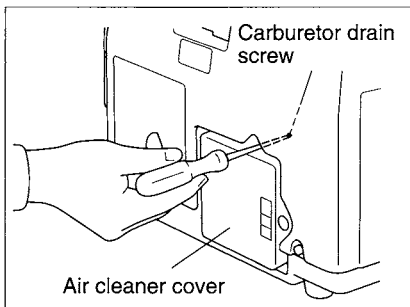

⚠ CAUTION

- Keep fire away during maintenance for storage.
- Perform maintenance for storage in a well ventilated area.
- Treat the drained fuel adequately.

TROUBLESHOOTING

Lots of failures are caused by insufficient inspection or unfamiliar handling.

Upon failure, inspect in the following procedure. If any fault persists, contact the dealer in a state where the failure is caused.

● The engine fails to start

Cause	Remedy
<ul style="list-style-type: none">● There is no fuel.● The fuel pipe is clogged.● The fuel strainer is clogged.● The carburetor is clogged.● The spark plug is dirty.● The electrode gap of the spark plug is incorrect.● The engine oil is insufficient.	<ul style="list-style-type: none">● Supply fuel.● Clean the fuel pipe.● Change the fuel strainer.● Clean the carburetor.● Clean the spark plug and dry it.● Adjust the electrode gap to the correct state.● Supply engine oil.

● Inspection of other parts

Cause	Remedy
<ul style="list-style-type: none">● The AC or DC protector is turned off.	<ul style="list-style-type: none">● Turn on the AC and DC protectors.
<ul style="list-style-type: none">● The total power consumption of the connected electric appliances exceeds the operating range of the generator.	<ul style="list-style-type: none">● Use only electric appliances so that the power consumption is contained in the operating range of the generator.
<ul style="list-style-type: none">● There is poor contact between the plug and outlet.	<ul style="list-style-type: none">● Securely insert the plug of the electric appliance into the outlet.

Wiring diagram

Control panel

----- -F01, F02 type only

