

# Operating Instructions

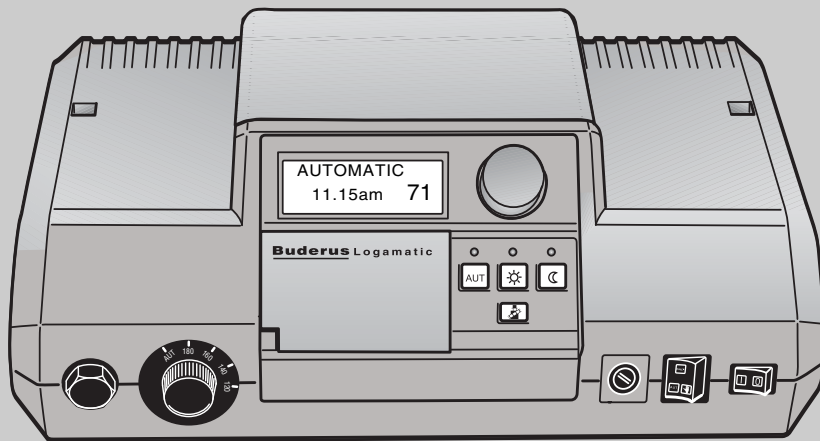

## Boiler Controls Logamatic 2107

For the user

Please read carefully before  
use.

6 720 618 081 - 08/2008 US/CA

**Buderus**



This product has been tested and is certified for both the US and Canadian markets and meets all applicable US and Canadian standards.

<b>1</b>	<b>Introduction</b>	<b>.5</b>
<b>2</b>	<b>What you should know about your heating system</b>	<b>.7</b>
<b>3</b>	<b>Tips on energy-efficient heating</b>	<b>12</b>
<b>4</b>	<b>Using the controls safely</b>	<b>13</b>
4.1	Correct use	13
4.2	For your safety	13
4.3	Cleaning the control panel	13
4.4	Disposal	13
<b>5</b>	<b>Using your controls</b>	<b>14</b>
<b>6</b>	<b>Basic functions</b>	<b>19</b>
6.1	Switching the controls ON	19
6.2	Switching the controls OFF	20
6.3	Standard display and operating values	21
6.4	Changing the operating mode	22
6.5	Setting the room temperature	24
6.6	Setting the DHW temperature	26
<b>7</b>	<b>Extended functions</b>	<b>28</b>
7.1	Changing the operating mode of the solar heating system	28
7.2	Selecting the standard program	30
7.3	Entering a vacation program	33
7.4	Setting the warm weather shutdown (WWSD) temperature	35
7.5	Setting constant mode for DHW	37
7.6	Changing the standard display	38
7.7	Setting the day and time	39
7.8	Daylight savings time	40
<b>8</b>	<b>BFU remote control</b>	<b>41</b>
8.1	General information on the BFU	41
8.2	Normal heating mode (day mode)	41
8.3	Setback heating mode (night mode)	42
8.4	Key functions	42
<b>9</b>	<b>Advanced programming options</b>	<b>45</b>
9.1	Modifying standard programs	45
9.2	Connecting heating phases	51
9.3	Creating a new heating program	53

<b>10</b>	<b>Troubleshooting</b> . . . . .	<b>55</b>
<b>11</b>	<b>Operation in the event of a fault</b> . . . . .	<b>58</b>
<b>12</b>	<b>Setup report.</b> . . . . .	<b>60</b>
<b>13</b>	<b>Flue gas test</b> . . . . .	<b>61</b>
<b>14</b>	<b>Keyword index.</b> . . . . .	<b>62</b>

# 1 Introduction

When you purchased your Logamatic 2107 controls, you chose a controls that makes it very simple to control your heating system. It will help you optimize your heat output while minimizing energy consumption.

With the Logamatic 2107 controls, you can run your heating system in a way that takes full account of all your financial, environmental and health needs. However, your personal comfort takes always priority.

Although at first glance it may appear very complex, the controls is extremely simple to use. Preset heating programs will allow you to heat rooms exactly when you need them to be heated.

Of course, you or your heating contractor can modify these preset heating programs and match them precisely to your requirements.

At the push of a button you can switch from normal heating mode (day mode) to setback heating mode (night mode), or you can just let the controls do this automatically.

You can also recharge your DHW tank at the push of a button.

## Push and turn

Other functions that you can use are hidden beneath a flap. You apply the "push and turn" principle to make your settings here.

Your settings are forwarded from the Logamatic 2107 to the heating system.

Your heating system offers a wealth of further useful functions. Some examples of these are:

- the automatic warm weather shutdown (WWSD)
- the vacation function

## Logamatic 2107 controls (brief description)

The Logamatic 2000 control system is designed primarily for use in single or two-family homes or small office buildings.

The Logamatic 2107 has a full range of safety features.

The standard features are:

- outdoor reset control of a low temperature boiler with single-stage burner
- control of a heating zone without mixers
- DHW thermostat
- control of a recirculation pump

With the full complement of equipment, the modular structure allows 2-stage or modulating burners and an additional heating zone with mixers to be used, and can be used to control a solar heating system.

You can adjust the operating panel so that you always have a good view of the display.

**About this manual**

Chapter 2 contains a synopsis of heating systems and their controls.

Chapter 3 gives you some tips on energy-efficient heating.

In Chapter 4 you will find some important notes on using the controls safely.

Chapter 5 explains how to get started with your controls.

The "basic functions" are illustrated in Chapter 6. Generally these functions are sufficient to fine-tune your heating system to your personal requirements.

Chapter 7 shows you the "extended functions" required for commissioning.

Chapter 8 explains how to use the remote control for your heating system.

If you want more in-depth information about the technology behind your controls, you can use Chapter 9 which illustrates further programming options for particular situations.

Chapter 10 offers troubleshooting if faults arise.

In Chapter 11 you will learn when and how to activate emergency mode.

Chapter 12 contains a setup report that you or your heating contractor can use to record your initial heating system settings in case you want to revert back to them at a later date.

In Chapter 13 you will find all you need to know about the flue gas test that must be carried out once a year.

Finally, the key word index in Chapter 14 will help you to quickly find the terms you are looking for.

## 2 What you should know about your heating system

Modern heating systems offer many functions for saving energy without sacrificing comfort. The first step in getting acquainted with this heating technology is the most difficult. After a short while, however, you will recognize the advantages of a heating system which is adjusted to your personal requirements. The more you are aware of the options offered by your heating system, the more advantage you will be able to take of them.

### **How does your heating system work?**

Your heating system comprises the boiler with burner, the heating controls, the pipes and the radiators.

A domestic hot water (DHW) tank heats the water for shower, bath or washing hands. It is important that the various components match each another. The burner consumes fuel (gas or oil) and heats the water inside the boiler. Using pumps, this hot water is then transported through the piping system to the radiators or the DHW tank.

Fig. 1 shows the heating circuit of a pumped central heating system: The burner (2) heats the water inside the boiler (1). This heating water is propelled by the pump (3) through the supply pipe (4) to the radiators (6). The heating water flows through the radiators, and in doing so, gives off some of its heat. The heating water flows back to the boiler via the return pipe (7); there, the circuit begins again.

The room temperature can be adjusted to your personal needs using the thermostatic radiator valves (5), if installed. All radiators are typically supplied at the same supply temperature. The heat transferred to the room thus depends only on the heating water flow rate, which can be manipulated via the thermostatic radiator valves or the pump speed.

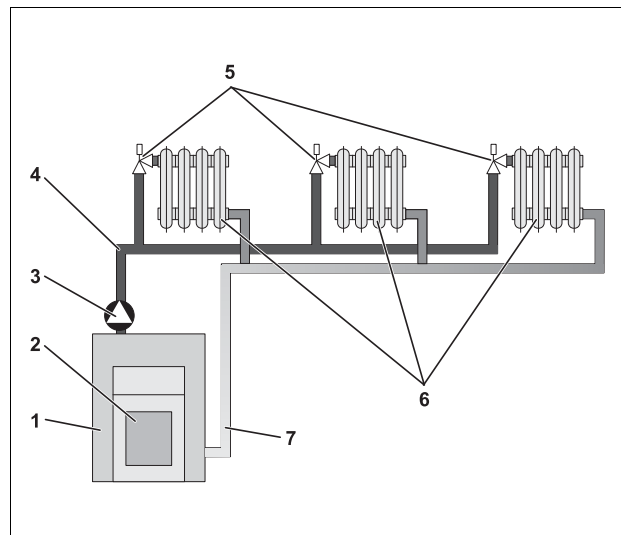

Fig. 1 Pumped central heating design

Item 1: Boiler

Item 2: Burner

Item 3: Pump

Item 4: Supply line

Item 5: Thermostatic radiator valves (optional)

Item 6: Radiators

Item 7: Return line

### What determines the heat demand of a room?

The heat demand of a room largely depends on the following factors:

- the outdoor temperature
- the desired room temperature
- the type of construction/insulation of the building
- the wind factor
- solar irradiation
- the internal heat sources (open fireplace, occupants, lamps, etc.)
- closed or open windows
- infiltration

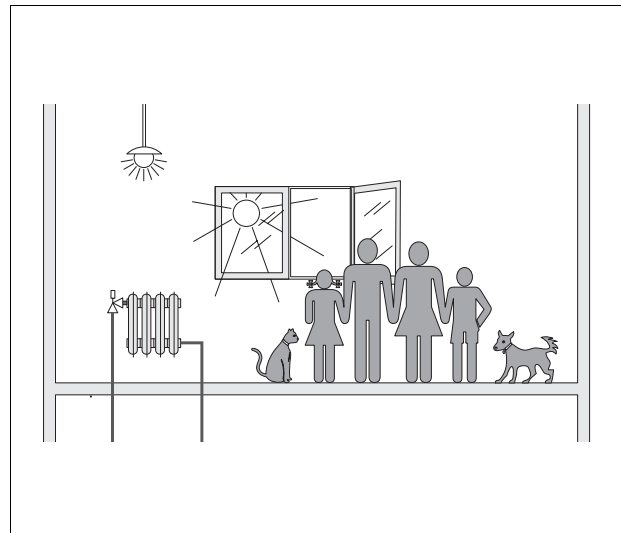

Fig. 2 Influences on the room climate

You should take these factors into consideration to achieve a comfortable room temperature.



### Why do you need a heating system controls?

The heating controls ensures comfortable heat and economical consumption of fuel and electrical energy. It switches the heat generator (boiler and burner) and pumps ON, if there is a heat demand. In doing so, it utilizes the components of your heating system at the correct time.

Furthermore, your heating system records different variables which influence the room temperature and compensates to minimize their effect.

### What does the heating controls calculate?

Modern heating controls calculate the boiler temperature required (the so-called supply temperature) subject to the outdoor temperature. The relationship between the outdoor temperature and the supply temperature is described as the characteristic heating curve. The lower the outdoor temperature, the higher the supply temperature must be to compensate for increased heat losses.

The heating controls can operate in three control modes:

- outdoor reset temperature control
- room temperature control
- outdoor reset temperature control with room temperature influence

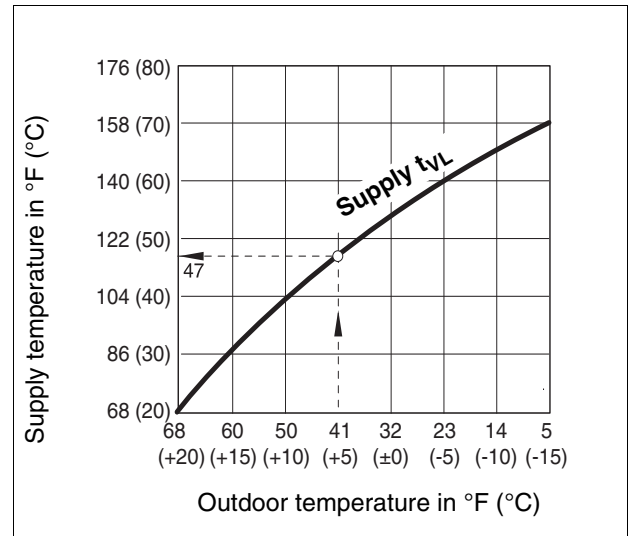

Fig. 3 Characteristic heating curve (example)

### Outdoor reset temperature control

With outdoor reset temperature control, the outdoor temperature is taken into account to determine the supply temperature. Room temperature fluctuations through solar irradiation, occupants, open fireplaces or similar external heat sources are not considered.

If you use this type of control, adjust the thermostatic radiator valves (if installed) so that the desired room temperature is obtained.

### Room temperature control

With room temperature control the heating controls calculates the boiler temperature required subject to the set and the actual room temperature.

To be able to utilize the room temperature control, a room representative of the whole house is needed where to mount the room sensor. All factors influencing the temperature in this "reference room" will also apply to all other rooms. Not every home has a room which meets these requirements. A pure room temperature control has, in such cases, certain limitations.

Should you, for example, open a window in the room where the room temperature is measured, the controls will "think" that you have opened the windows in all rooms in your home and will begin to heat vigorously.

Or conversely: You measure the temperature in a south-facing room with significant solar gain. Now the controls "thinks" that it is as hot in all rooms as in the reference room; consequently the boiler output will be severely cut back so that, for example, the north-facing rooms are too cold.

With this kind of control no thermostatic radiator valves should be installed in the reference room.

### Outdoor reset temperature control with room temperature influence

The outdoor temperature dependent control with room temperature influence combines the advantages of both above control modes. The required supply temperature, which is mainly subject to the outdoor temperature, is influenced by the room temperature only to a limited degree. This achieves improved comfort within the room containing the room sensor, without ignoring the other rooms.

With this kind of control no thermostatic radiator valves should be installed in the reference room.

### Influence of thermostatic radiator valves?

If you want to reduce the room temperature in the reference room, for example, and you therefore close the thermostatic valve further, the flow rate through the radiator will be reduced and, therefore, less heat is transferred to the room. This reduces the room temperature. The heating controls will attempt to counteract the falling room temperature by raising the supply temperature. However, raising the supply temperature will not raise the room temperature, as the thermostatic valve continues to limit the room temperature.

A supply temperature which is too high results in unnecessary heat losses in boiler and pipes. At the same time, the temperature in all rooms without thermostatic valves increases due to the higher boiler water temperature.

### Why do I need a timer?

Modern heating systems are equipped with a timer to save energy. This allows setting up an automatic changeover between two different room temperatures, subject to time, e.g. a reduced room temperature at night, while operating your heating system with the standard room temperature during the day.

You have four options for reducing the room temperature. Your heating contractor will select and set up one of these options according to your requirements:

– **Total shutdown (no room temperature control)**

With total shutdown of the heating system, no pumps or other system components are running. Heating only recommences if there is a risk of the heating system freezing up.

– **Reduced room temperature (a reduced room temperature will be maintained)**

Heating with reduced room temperature (night mode) differs from the standard heating mode (day mode) only in that it has a lower required room temperature at times at which less heating is required, e.g. at night.

– **Change between total shutdown and reduced heating subject to room temperature**

When changing from total shutdown to reduced heating, the total shutdown will be activated subject to the room temperature when the actual room temperature exceeds the set room temperature. This function is only possible with a room temperature sensor installed.

– **Change between total shutdown and reduced heating subject to outdoor temperature**

When changing from total shutdown to reduced heating, the total shutdown will be activated subject to the outdoor temperature when the actual outdoor temperature exceeds the set outdoor temperature.

### What are heating zones?

A heating describes the loop taken by the heating water from the boiler via the radiators and back to the boiler (Fig. 1 on page 8). A simple heating zone comprises a heat generator, a supply pipe, a radiator and a return pipe. A pump installed into the supply pipe circulates the heating water. Provided that the pipes are well insulated, all the radiators will be supplied with the same supply temperature.

Several heating zone may be connected to one boiler, for example, one heating zone for supplying radiators and a second heating zone to supply an underfloor radiant heating system. In this case, the radiators are supplied at a higher supply temperature than the radiant heating system.

Different supply temperatures in a heating system can only be achieved if a three-way valve is installed between the boiler and the underfloor radiant heating system, for example.

Using an additional temperature sensor in the supply of the heating zone, cold return water is added to the hot supply water via the three-way valve to achieve the required lower temperature. It is important to note that heating zones with three-way valves require an additional pump. This pump enables the second heating zone to be operated independently of the first heating zone.

### 3 Tips on energy-efficient heating

Here are a few tips on how to heat economically, without sacrificing comfort:

- Only heat if you need warmth. Use the preset heating programs (standard programs) on the controls or those which you have tailored to your personal needs.
- Ventilate smartly during the cold season: Open the window three to four times per day for approx. five minutes. Having the window slightly open all the time does not provide fresh air changes and wastes valuable energy.
- Close the thermostatic valves while ventilating.
- Windows and doors are places where a lot of heat is lost. So check that the doors and windows are properly sealed.
- Never position large objects such as a sofa or a desk immediately in front of the radiators, and maintain a clearance of at least 1 foot (30cm). Otherwise the heated air cannot circulate and heat the room adequately.
- In those rooms which you occupy during the day, a room temperature of 70°F (21°C) is recommended. 63°F (17°C) may be sufficient at night. To achieve this, use the standard heating mode (day mode) and the setback mode (night mode), (see Chapter 6 "Basic functions", page 19).
- Never overheat rooms; overheated rooms are unhealthy and waste money and energy. If you reduce the daytime room temperature, for example, from 70°F (21°C) to 68°F (20°C), you will save around six percent on your heating bill.
- Heat in an energy-conscious manner during shoulder seasons too, and make use of the warm weather shutdown (WWSD) function (see Chapter 7 "Extended functions", page 28).
- A comfortable room climate depends not only on the room temperature but also on the relative humidity. The drier a room, the cooler it feels. You can optimize the relative humidity with house plants.
- You can also save energy when heating DHW. Only operate the DHW recirculation pump via a timer. Research has shown that it is generally sufficient to run the DHW recirculation pump for three minutes in every half hour.
- Arrange with your local heating contractor to service your heating system annually.

## 4 Using the controls safely

### 4.1 Correct use

The Logamatic 2107 controls is designed to control and monitor heating systems in single family homes and small office buildings. It controls the room temperature following a heating program, and sets DHW temperature.

### 4.2 For your safety

The Logamatic 2107 controls has been designed and built in accordance with current standards and safety requirements.

However, accidents resulting from inappropriate handling of this device cannot be completely excluded.

- Only operate the Logamatic 2107 controls as intended and when it is in perfect working order.
- Let your local heating contractor instruct you in the proper operation of your system.
- Please read these operating instructions carefully.



**WARNING!**

#### RISK OF LIFE

- In an emergency, switch off at the emergency shutoff switch outside the boiler room. Let your local heating contractor immediately remedy all heating system faults.



**WARNING!**

#### RISK OF LIFE

from electric shock.

- All tasks listed in these service instructions, which require the opening of the control panel, must only be carried out by trained personnel.



**WARNING!**

#### RISK OF SCALDING

The DHW tank temperature is preset to 140°F (60°C). There is a serious risk of scalding from hot water above 122°F (50°C). Verify that your heating contractor has installed a thermostatically controlled mixing valve. Please note that pipes and fixtures can get very hot.

- In such cases, only ever draw-off mixed water (hot and cold).



**CAUTION!**

#### SYSTEM DAMAGE

from frost.

The heating system can freeze up if the control panel has been switched off.

- Protect your heating system against frost when freezing temperatures are expected.
- With the controls switched OFF, drain the water from the boiler, the DHW tank and the pipes of the heating system.

### 4.3 Cleaning the control panel

The Logamatic 2107 control panel is housed in a resilient plastic housing.

- Only clean the controls with a damp cloth and a mild cleaning agent.

### 4.4 Disposal

- Dispose of the Logamatic 2107 controls packaging in an environmentally responsible manner.
- Dispose of defunct controls in an environmentally acceptable form, through an approved organization.

## 5 Using your controls

You can set your heating system via your Logamatic 2107 controls. The clearly arranged controls make it very easy to use.

### Controls on the Logamatic 2107 controls

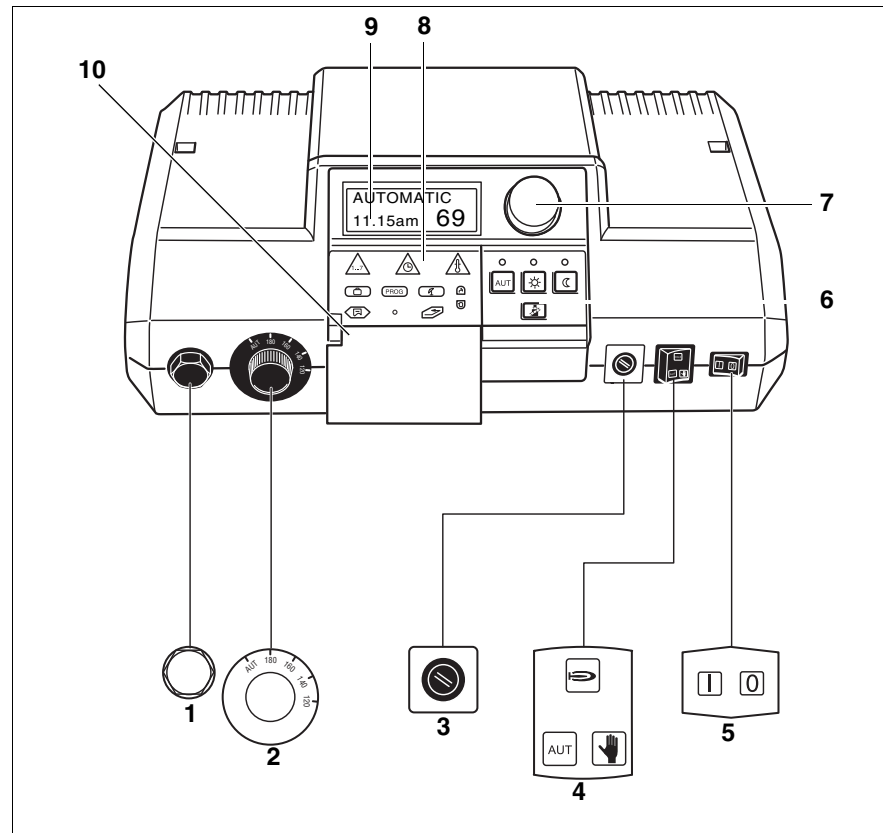

Fig. 4 Controls on the Logamatic 2107 controls

- Item 1:** Manual reset high limit (STB)
- Item 2:** Boiler water thermostat
- Item 3:** Fuse (10 Amp)
- Item 4:** Switch for Automatic mode, Emergency mode
- Item 5:** ON/OFF switch
- Item 6:** Keys for basic functions
- Item 7:** Dial
- Item 8:** Keys for extended functions
- Item 9:** Display
- Item 10:** Flap

**Manual reset high limit (STB)**

The manual reset high limit prevents your heating system from running at temperatures in excess of the temperatures for which it was designed.

**Boiler water thermostat**

The boiler water thermostat is normally set to "AUT".

Only set the boiler water thermostat to limit the water temperature in emergency mode.

**Switch for Emergency mode**

This switch is used to change to emergency mode in the event of a fault, for example. The default setting is Automatic.

**ON/OFF switch**

The ON/OFF switch is used to switch the 2107 controls ON and OFF.

**Dial**

The dial is used to set new values and to move through the menus.

**Flap**

Keys for the extended functions are hidden behind the flap.

You must therefore open the flap in order to use the extended functions.

### Keys for basic functions

These keys are used to control the basic functions.

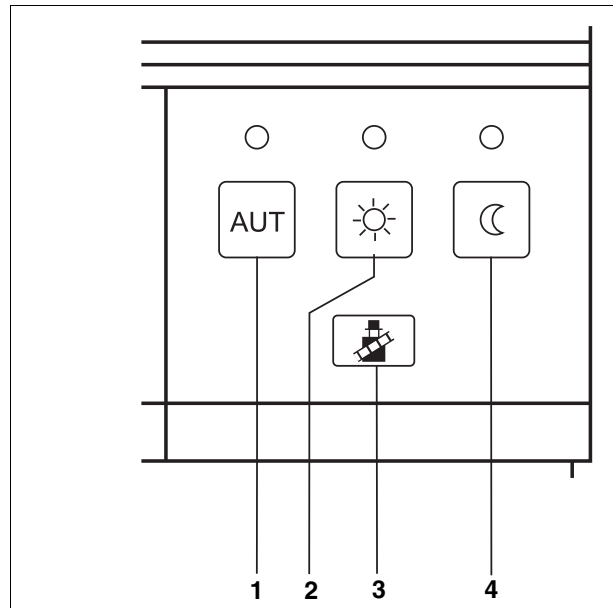

Fig. 5 Keys for basic functions

**Item 1:** Automatic mode with timer using the internal program

**Item 2:** Normal heating mode (day mode)

**Item 3:** Flue gas test (for measuring flue gases)

**Item 4:** Setback heating mode (night mode)

A green LED is allocated to each key (Fig. 5, **Item 1, 2 and 4**).  
The LEDs inform you of the current operating state.



AUT key

LED lights up = automatic mode is active. Your heating system follows the internal program. The "normal heating mode" (day mode) LED or the "setback heating mode" (night mode) LED also lights up.



"Day mode" key (manual mode)

LED lights up = normal heating mode (timer is disabled if AUT is OFF).



"Night mode" key (manual mode)

LED lights up = setback heating mode (timer is disabled if AUT is OFF).



"Flue gas test" button

This is used by your heating contractor to measure the flue gases and perform a combustion test.



### Keys for extended functions

These keys are used, for example, to enter the day, set the time, select temperature values, etc.

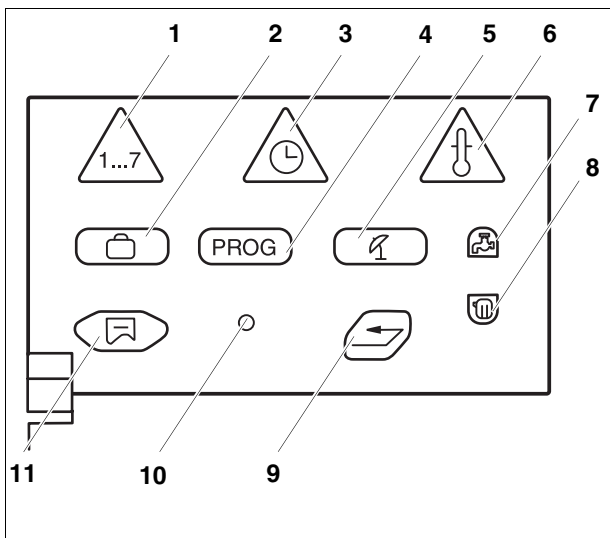

Fig. 6 Keypad for extended functions

- Item 1:** "Weekday" key – Enter the day of the week
- Item 2:** "Vacation" key - Set vacation function
- Item 3:** "Time" key – Set the time
- Item 4:** "PROG" key – Select program
- Item 5:** "WWSD" key – Sets the warm weather shutdown temperature
- Item 6:** "Temp" key – Select temperature values
- Item 7:** "DHW" key – Enter the domestic hot water temperature
- Item 8:** "Heating zone" key – Call up the heating circuits
- Item 9:** "Enter" key – Returns to standard display
- Item 10:** "Install" key – Call up the service level
- Item 11:** "Display" key – Select the standard display

## Display

The display shows set and actual values and temperatures, e.g. the measured room temperature (only with BFU connected), for example.

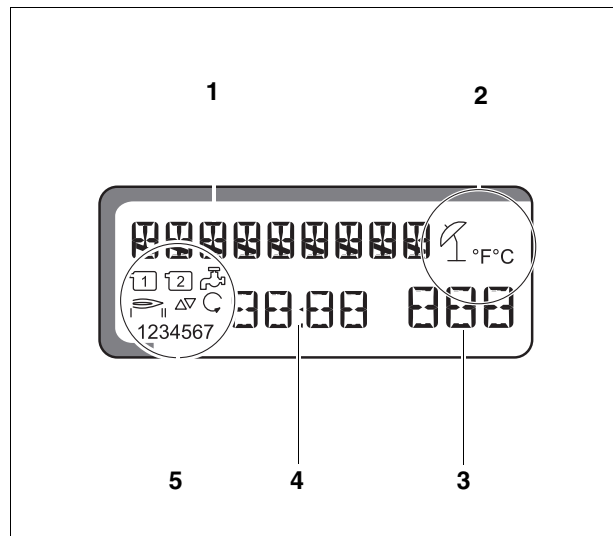



Fig. 7 Display

**Item 1:** Display text

**Item 2:**  Warm weather shutdown is active  
°F °C Temperature unit

**Item 3:** Display value e. g. room temperature

**Item 4:** Display value e. g. time

**Item 5:**  Heating zone pump 1

 Heating zone pump 2

 DHW tank filling pump / solar pump (flashing)

 Burner stage 1,2

 Mixing valve open/closed

 DHW recirculation pump

**1234567** Days of the week:

1 = Monday

2 = Tuesday

3 = Wednesday

4 = Thursday

5 = Friday

6 = Saturday

7 = Sunday

## 6 Basic functions

This chapter contains information on how to start up, shut down, and the simple controls of the Logamatic 2107 controls.

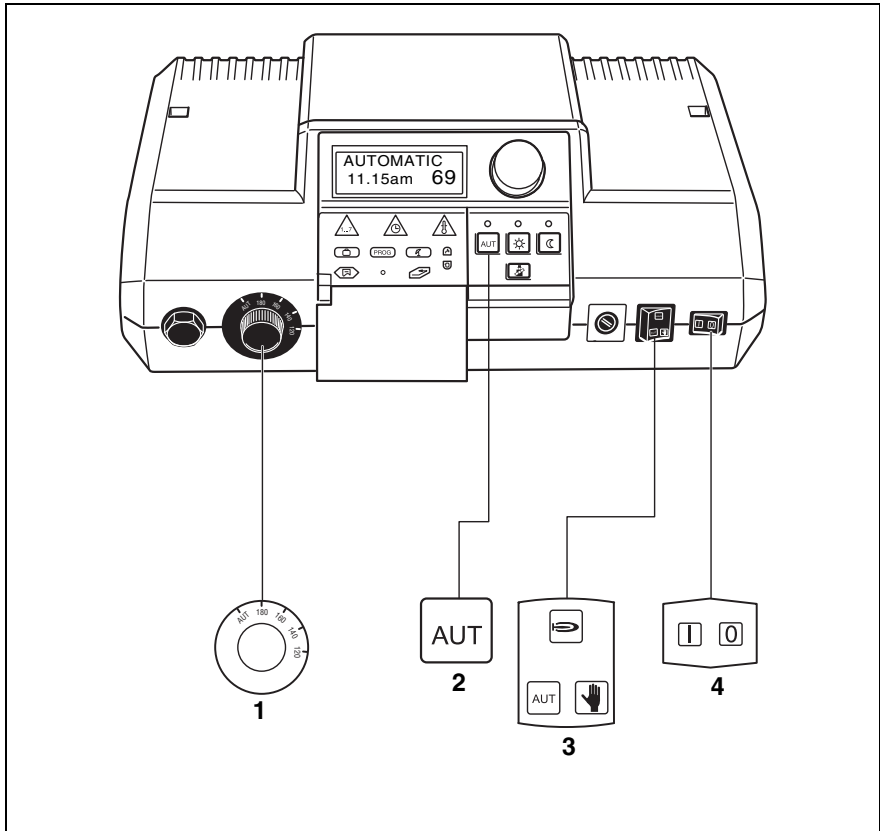

Fig. 8 Keys required to start up

### 6.1 Switching the controls ON

- Set the ON/OFF switch to "I" (ON) (Fig. 8, **Item 4**).
- Set the boiler water thermostat to "AUT" (Fig. 8, **Item 1**).
- Set the Automatic mode, Emergency mode, Heating and DHW switch to "AUT" (Fig. 8, **Item 3**).
- Press the "AUT" key to start automatic mode with program (see "Changing the operating mode" page 22) (Fig. 8, **Item 2**).

## 6.2 Switching the controls OFF



Set the ON/OFF switch to "0" (Fig. 8, **Item 4**).



**CAUTION!**

### **BOILER DAMAGE**

from frost.

- Frost protection is only active if the control device is switched ON. Switch off the controls and drain the water from the boiler, the DHW tank and the pipes of the heating system. The system is only protected from frost, if it is completely dry.

### 6.3 Standard display and operating values

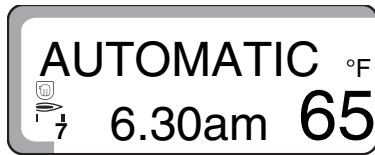

In normal mode, the display shows the day of the week, the time, the operating mode and the set room temperature.

#### Displaying other operating values

The dial can be used to display measured values for all connected temperature sensors and the operating hours of the burner.

The following operating values are displayed in sequence:

- Boiler water temperature
- DHW temperature
- Outdoor temperature
- Supply temperature in heating zone 2 (if mixer module FM 241 is used)
- Collector temperature (if solar module FM 244 is used)
- DHW solar temperature (if solar module FM 244 is used)
- Room temperature for heating zone 1 (if remote control is connected)
- Room temperature for heating zone 2 (if remote control is connected)
- Burner operating hours
- Operating hours for burner stage 2 (if 2-stage FM 242 module is used)
- Operating hours of solar pump (if solar module FM 244 is used)

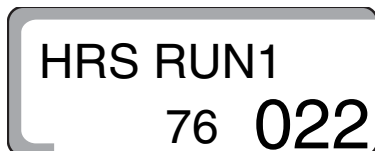

The operating hours are represented by a 5-digit display. The two numbers are of different sizes.

Please note that this counter cannot be reset.

## 6.4 Changing the operating mode

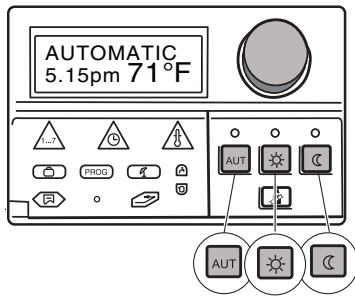

The keys on the 2107 controls (see diagram) perform the same functions as the keys on the remote control. In heating zone with remote control, the operating mode is set on the remote control. In this case, the keys on the controls are blocked, although the LEDs will indicate which operating mode is set on the controls.

For two heating zones, the operating mode keys and LEDs apply

- to both heating zones simultaneously if no remote control is installed,
- to the heating zone without the remote control if a remote control is installed on the other heating zone,
- disabled if remote controls are installed on both heating zones (in this case, the LEDs show the operating mode of the most recently modified heating zone or for the DHW).

You can operate the controls in two ways:

- Automatic mode
- Manual mode

### Automatic mode

Your heating system follows a selected heating program, i.e. it provides heat and DHW at preset times.

Typically, homes are heated less at night than during the day. With the Logamatic 2107 controls, you do not have to close the thermostatic valves on the radiators every night, and then open them again each morning.

The unit automatically switches between normal heating mode (day mode) and the setback mode (night mode).

The times at which your heating system switches between normal heating mode (day mode) and setback (night) mode are set at the factory using standard programs (see "Selecting the standard program" on page 30). However, you or your heating contractor can modify these settings as desired.

### Manual mode

For example, if you want to heat longer in the evening or not quite as early in the morning, you can also select the manual normal heating mode (day mode) or setback heating mode (night mode) (see "Selecting manual mode" on page 23). The selected operating mode remains set until changed.

### Selecting automatic mode

In addition to the green LED above the "AUT" key, the LED above the "Day mode" or "Night mode" key also lights up, depending on which heating mode is currently active based on the selected program and the time of day.

Normal heating mode and setback heating mode automatically become active at the switching times set in the selected program.

If there are two heating zones present, but only one of these is equipped with a remote control, the LED displays on the controls apply to the heating zone without remote control.



Press the "AUT" key to switch to automatic mode.

Your heating system follows a selected preset heating program, i.e. it provides heat and DHW at preset times.

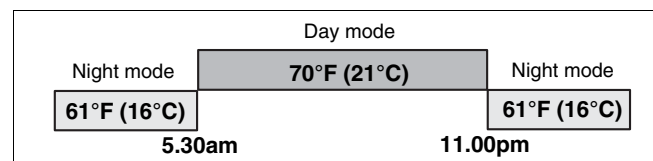

Fig. 9 Normal heating mode (day mode) and setback heating mode (night mode)

### Selecting manual mode

Press the "Day mode" or "Night mode" key to switch to manual mode.

In this operating mode, the system is heated to the set day or night room temperature, regardless of which heating program is set.

The heating program is disabled.



Press "Day mode". Your heating system is constantly in normal heating mode. The LED above the "Day mode" key lights up.



Press the "Night mode" key: Your heating system is constantly in setback heating mode, which causes the room temperature to be dropped. The LED in the "Night mode" key lights up.



#### USER NOTE

The DHW heating is also switched off when you select "Night mode" (factory default), i.e. the tank temperature is not maintained.

## 6.5 Setting the room temperature

### REMOTE 1

If a remote control is connected, it can only be used to set the room temperature for normal heating mode (day mode) and setback heating mode (night mode) for the associated heating zone.

As soon as an operating mode key is pressed on the controls, "REMOTE" appears to indicate that a remote control is connected. The "AUT", "Day mode" and "Night mode" keys on the controls are disabled for this zone and replaced by the keys on the remote control.

Only the temperatures that were set via the remote control appear on the Logamatic 2107 display.

If no remote control is connected, you can enter your room temperature for normal heating mode (day mode) and setback heating mode (night mode) on the controls.

If there are two heating zones connected without remote control, the settings on the controls apply to both heating zones.

If no remote control is installed, the desired room temperature, rather than the measured room temperature, appears on the display.

Never overheat rooms; overheated rooms are unhealthy and waste money and energy.

A comfortable room climate depends not only on the room temperature but also on the relative humidity.

70°F (21°C) is set at the factory for the normal heating mode (day mode) and 63°F (17°C) for setback heating mode (night mode).

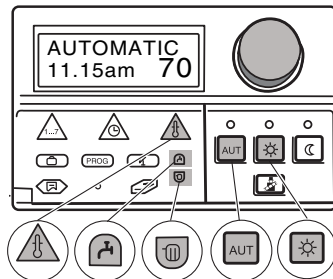



**Entering the room temperature (heating zones without remote control)**

If your room temperature is too high, reduce the temperature.  
If your room temperature is too low, increase the temperature.

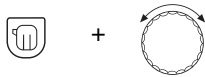

Press and hold down the "Heating zone" key and turn the dial until the heating zone without remote control appears on the display.



Press "Day mode".

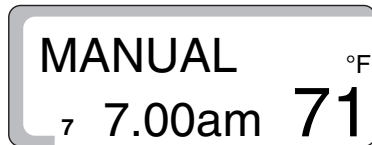

The display contains "MANUAL", the day, the time and the room temperature for normal heating mode (day mode).

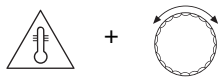

Hold down the "Temp" key and turn the dial until you reach the desired day temperature (in this case "71°F").

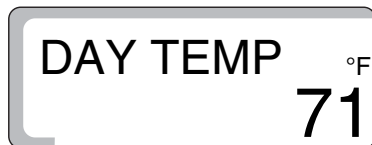

The day room temperature is now adjusted to 71°F.

Release the "Temp" key to store your input.



Press "AUT" to select automatic mode.

**USER NOTE**

To set the room temperature for night mode, simply repeat the process described above, in this case pressing the "Night mode" key, rather than the "Day mode" key.

## 6.6 Setting the DHW temperature

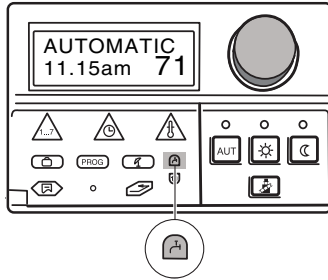

The Logamatic 2107 controls allows you to heat the DHW in an energy-conscious manner. For this purpose, the DHW heating is equipped with a timer. You can switch on the DHW heating by setting the desired temperature for the domestic hot water. To save energy, DHW heating is switched off in night mode.

The DHW heating is set at the factory to "DHW AUTO" (automatic mode).

In this setting, the DHW heating starts 30 minutes before one of the two heating zone switches to normal heating mode (day mode) and ends as soon as both heating zones are in setback heating mode (night mode) with timer.

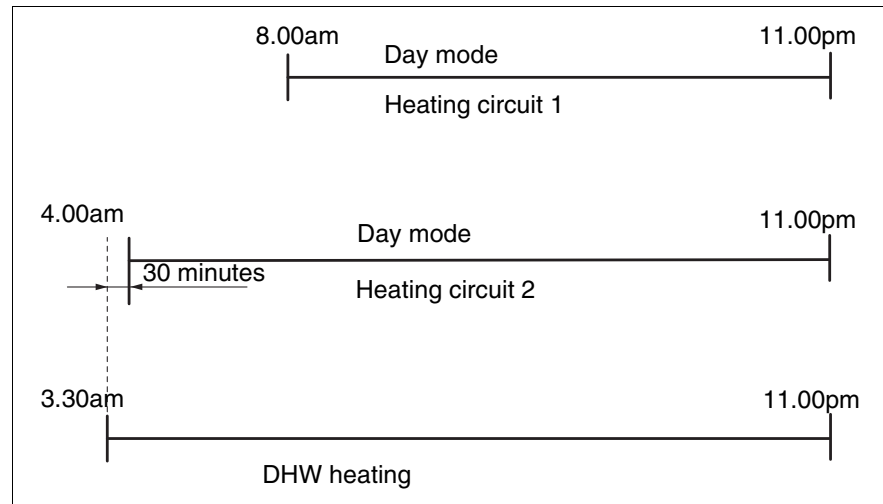

Fig. 10 Example: DHW heating

The DHW heating is set at the factory to 140°F (60°C) for automatic mode.



### USER NOTE

If a recirculation pump is installed for the DHW, it will be activated at the same time as the DHW heating.

### Setting DHW temperature

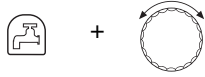

Hold down the "DHW" key and turn the dial until you reach the desired DHW temperature (in this case "122°F (50°C)").

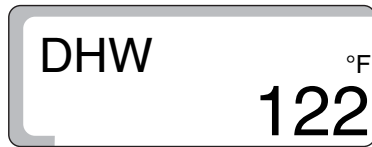

The DHW temperature is now set to 122°F (50°C).

Release the "DHW" key. The DHW temperature is saved.

	Input range	Factory setting
DHW temperature	86 – 140°F (30 – 60°C)	140°F (60°C)

## 7 Extended functions

This section contains information about the extended functions. This includes information on setting the solar heating system or about heating programs.

### 7.1 Changing the operating mode of the solar heating system

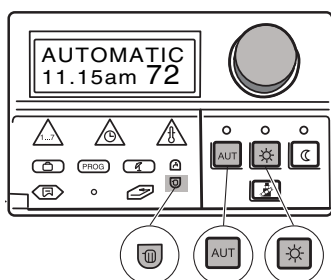

If the controls is equipped with a module for controlling a solar heating system (FM 244), you can also set the operating mode of the solar heating system.

The operating mode can be set for the solar heating system using the "AUT", "Day mode" and "Night mode" keys, just as for the heating circuits. Your heating contractor can make the controls settings for you to ensure you derive maximum benefit from your solar heating system.

#### Solar automatic operating mode

In Solar automatic operating mode, the system automatically controls whether the DHW should be recharged by the boiler or whether the solar heating system is supplying sufficient energy.

In this mode, the system works fully automated.

- Open flap.

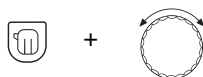

Hold down the "Heating zone" key and turn the dial until "SOLAR" appears.

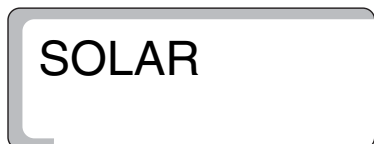

Release the "Heating zone" key to save your input.



Press "AUT" to select automatic mode.

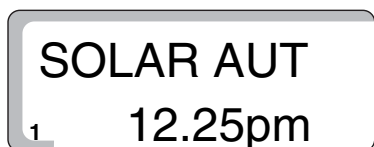

The display reads "SOLAR AUT".

### Solar manual operating mode

Function test of the solar heating system

In this mode, the system no longer works automatically. The solar pump will be operating if the system status allows (e.g. collector not in stagnation mode). Solar manual operating mode is automatically terminated after 30 minutes and automatic mode is reactivated.

- Open flap.

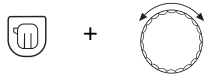

Hold down the "Heating zone" key and turn the dial until "SOLAR" appears.

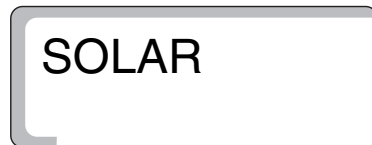

Release the "Heating zone" key to save your input.



Press "Day mode".

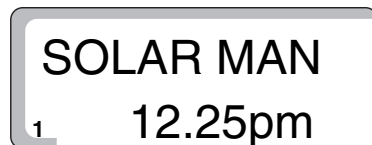

The display reads "SOLAR MAN".

### Solar off operating mode

Switching off solar heating system



#### USER NOTE

If you wish to manually and permanently deactivate the solar system, simply repeat the process described above, in this case pressing the "Night mode" key, rather than the "Day mode" key.

The solar pump remains off permanently, regardless of the system status.

## 7.2 Selecting the standard program

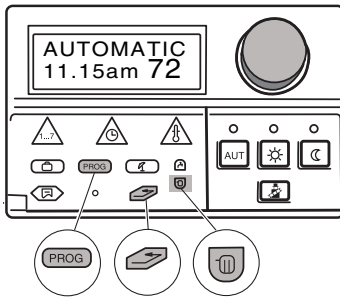

### What is a heating program?

A heating program automatically switches between normal heating mode (day) and setback heating mode (night mode) at preset times. This automatic changeover is implemented using the internal clock.

Please consider the following points before using these options:

- What time do you want day mode to start (and which days of the week)?
- Are there days when you don't need to heat during the day?
- When in the evening can you switch to night mode?

The time taken for your heating system to reach the desired temperature may vary. It will depend on the outdoor temperature, the building insulation and the drop in room temperature.

With the Logamatic 2107 controls, Buderus offers eight different preset heating programs (see chapter "Summary of standard programs" page 31). These can be used independently for the 1st and 2nd heating zones.

The "FAMILY" heating program (see chapter "Summary of standard programs") is preset at the factory.

If none of the preset heating programs suits your lifestyle, you can also create your own heating programs.



### USER NOTE

The DHW heating is activated when you set "DHW AUTO" operating mode and while one or both heating zone is in "day mode".

---

### Summary of standard programs

Select the standard program that comes closest to your needs. If you require a customized program, then you can adapt the individual switching points.

You can choose from the following eight standard programs.

You can enter up to 42 switching points in total per heating zone.

Prog Name	Day	On <sup>1)</sup>	Off <sup>2)</sup>	On <sup>1)</sup>	Off <sup>2)</sup>	On <sup>1)</sup>	Off <sup>2)</sup>
FAMILY	1-4	Monday to Thursday	5.30am	10.00pm			
	5	Friday	5.30am	11.00pm			
	6	Saturday	6.30am	11.30pm			
	7	Sunday	7.00am	10.00pm			
EARLY	1-4	Monday to Thursday	4.30am	10.00pm			
Early start	5	Friday	4.30am	11.00pm			
	6	Saturday	6.30am	11.30pm			
	7	Sunday	7.00am	10.00pm			
LATE	1-5	Monday to Friday	6.30am	11.00pm			
Late shift	6	Saturday	6.30am	11.30pm			
	7	Sunday	7.00am	11.00pm			
PM HOME	1-4	Monday to Thursday	5.30am	8.30am	12.00pm	10.00pm	
Part-time work in the morning	5	Friday	5.30am	8.30am	12.00pm	11.00pm	
	6	Saturday	6.30am	11.30pm			
	7	Sunday	7.00am	10.00pm			
AM HOME	1-4	Monday to Thursday	6.00am	11.30am	4.00pm	10.00pm	
Part-time work in the afternoon	5	Friday	6.00am	11.30am	3.00pm	11.00pm	
	6	Saturday	6.30am	23.30pm			
	7	Sunday	7.00am	22.00pm			
NOON	1-4	Monday to Thursday	6.00am	8.00am	11.30am	1.00pm	5.00pm
At home in the middle of the day.	5	Friday	6.00am	8.00am	11.30am	11.00pm	
	6	Saturday	6.00am	23.00pm			
	7	Sunday	7.00am	22.00pm			
SINGLE	1-4	Monday to Thursday	6.00am	8.00am	4.00pm	10.00pm	
	5	Friday	6.00am	8.00am	3.00pm	11.00pm	
	6	Saturday	7.00am	11.30pm			
	7	Sunday	8.00am	10.00pm			
SENIOR	1-7	Monday to Sunday	5.30am	10.00pm			
OWN PROG	1	Monday	-				

Tab. 1 Summary of standard programs

1) "ON"  $\triangleq$  the set day temperature

2) "OFF"  $\triangleq$  the set night temperature

After selection, the display contains the program description, as shown in the table.

**Selecting a standard program (selecting a program for a heating zone)**

- Open flap.

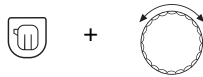

Hold down the "Heating zone" key and turn the dial until "Heating zone 1", for example, is displayed.

Release the "Heating zone" key.

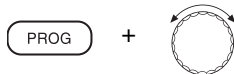

Hold down the "PROG" key and turn the dial until the desired standard program (in this case "LATE") is displayed.



Release the "PROG" key to save your input.

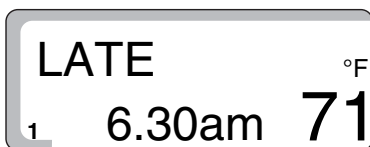

The display shows the first switching point for "LATE".



Press "Enter" to return to the standard display.

The heating system is now running with your individual "LATE" program for heating zone 1.

**USER NOTE**

At any time that you are unsure about how the timer is programmed, you can return to the initial state by simply selecting a standard program.

**USER NOTE**

If you wish to select a program for heating zone 2, for example, you must first select heating zone 2.



### 7.3 Entering a vacation program

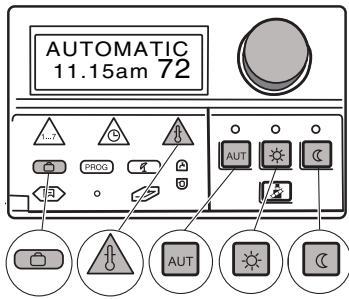

You can interrupt the set heating program if you will be on vacation for the next few days, for example. You will need less heat during this time.

The advantage over setback heating mode (night mode) is that you can return to an already heated home when you get back from your vacation, due to the fact that heating resumes in time.

The vacation program is only active for the heating zone(s) that is/are in "Automatic" operating mode. If heating zone 1 and, if installed, heating zone 2 are set to the vacation program, then the DHW heating also remains switched off. The solar heating system is switched off for most of your vacation to avoid expending energy on the pump. It is switched on again, however, 3 days before the end of your vacation to allow charging the tank.

The vacation program starts as soon as it is programmed (day 1) and ends when the set time has elapsed. The last day of vacation should be the day before you return. If you program "Vacation = 1 day", the vacation program will end on the same day at midnight.

- Open flap.



Hold down the "Vacation" key and turn the dial until the number of days of your vacation is displayed (in this case "15").

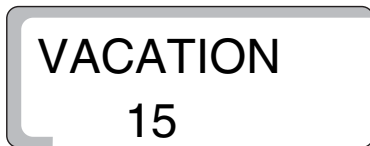

Today is counted as the first day of your vacation.

Release the "Vacation" key to store your input.

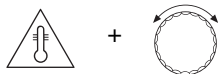

Hold down the "Temp" key and turn the dial until the room temperature to be maintained during your vacation is displayed, e.g. 50°F (10°C).

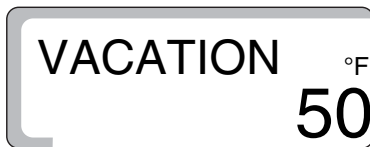

Release the "Temp" key to store your input.

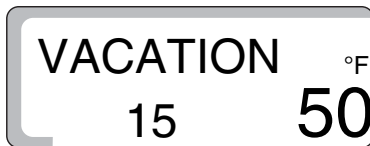

Your vacation dates and the room temperature are stored. Room temperature settings on the remote control will have no effect during your absence.



#### USER NOTE

If two heating zones are installed, the vacation program will apply to both heating zones if both are in automatic mode.

### Canceling a vacation program

The procedure for canceling a (currently) running vacation program and then switching to normal heating mode is as follows:

- Open flap.

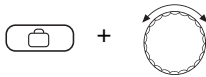

Hold down the "Vacation" key and turn the dial until "VACATION 00" appears on the display.

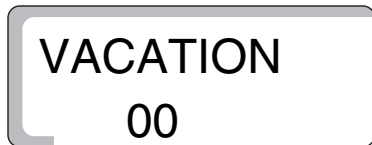

Release the "Vacation" key to store your input.

The normal heating program starts to work again in automatic mode.

### Temporarily interrupting a vacation program

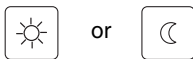

Press the "Day mode" or "Night mode" key on the remote control of the particular heating circuit (if installed), or the controls itself.

### Continuing a vacation program



Press "AUT" to select automatic mode.

## 7.4 Setting the warm weather shutdown (WWSD) temperature

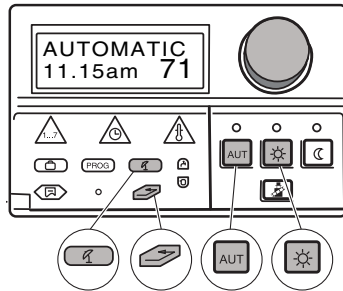

In addition to the outdoor temperature, your Logamatic 2107 controls considers the ability of the building to store heat (called the "adjusted outdoor temperature" below) and automatically delays changing over between summer and winter mode. The changeover takes place regardless of the actual time of year.

The automatic summer / winter changeover only applies to heating zones that are in automatic mode with timer.

### Summer mode

The heating mode will be switched off after a delay which depends on the building's capacity to store heat and its thermal insulation if the "adjusted outdoor temperature" exceeds the changeover threshold (factory default 63°F (17°C)).



This symbol on the display indicates Summer mode.

If a remote control is installed, the LED next to this symbol lights up.



Press the "Day mode" key if you want to heat at short notice in summer mode.



Press "AUT". The system then returns to automatic Summer mode.



Press "Back" to return to the standard display.

The heating system will now run following the default program for heating zone 1, for example.



### USER NOTE

The DHW system remains operational even if Summer mode is active.

### Winter mode

The heating is restarted if the "adjusted outdoor temperature" falls below the factory-set changeover threshold of 63°F (17°C).



This symbol no longer appears on the display.

### Setting the automatic warm weather shutdown temperature

- Open flap.

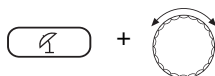

Hold down the "WWSD" key and turn the dial until "WWSD" appears and the desired "adjusted outdoor temperature" is displayed.

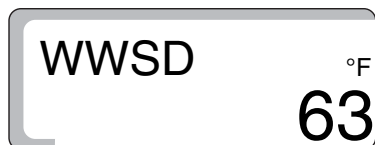

Release the "WWSD" key to store your input.



The symbol and the word "SUMMER" appear in the display when the controls automatically changes over to Summer mode.

If a remote control is installed, the LED next to this symbol lights up.



#### USER NOTE

In all modes (WWSD ON or OFF), all zone pumps are activated for approximately 30 seconds every Wednesday at 12.00pm in order to avoid pump seizing up during the extended off cycle. The actuator is then run for approximately 3 minutes (known as pump kick).

### Setting constant Summer or Winter mode

In this setting, the automatic warm weather shutdown is deactivated.

- Open flap.

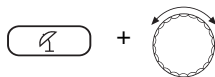

Hold down the "WWSD" key and turn the dial until "SUMMER" appears.

Release the "WWSD" key.



The symbol and the word "SUMMER" appear in the display when the controls automatically changes over to Summer mode.

If a remote control is installed, the LED beside this symbol lights up.



#### USER NOTE

Reverse the order described above to set constant Winter mode.

Hold down the "WWSD" key and turn the dial until "WINTER" appears. The "SUMMER" symbol no longer appears on the display.

## 7.5 Setting constant mode for DHW

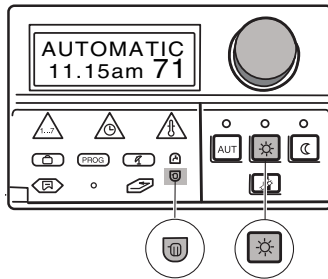

In certain situations it may be necessary to have DHW available all the time during day and night.

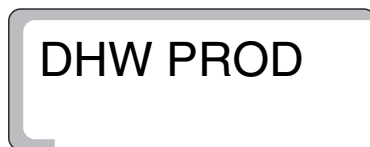
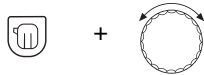

- Open flap.

Hold down the "Heating zone" key and turn the dial until "DHW PROD" appears.

Release the "Heating zone" key to save your input.



Press "Day mode".

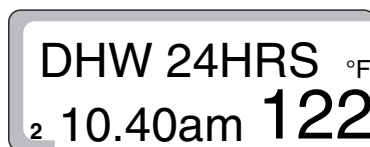

The display reads "DHW 24HRS".

Domestic hot water is now produced around the clock.

After 5 minutes, the controls automatically switches back to the standard display.



### USER NOTE

If you wish to **switch OFF the DHW heating**, simply repeat the process described above, in this case pressing the "Night mode" key, rather than the "Day mode" key. The DHW heating is now permanently switched OFF. It can be manually activated by pressing the "DHW" key.

If you wish to set the DHW heating to **automatic mode**, again repeat the process described above, in this case pressing the "AUT" key, rather than the "Day mode" key. The DHW heating is will then run in automatic mode.



### USER NOTE

If you also run a solar heating system with the controls and there is sufficient solar gain, then the DHW temperature generated by the boiler can be automatically reduced in favor of collecting solar energy. However, the relevant function must first be activated at the service level by your heating contractor.

## 7.6 Changing the standard display

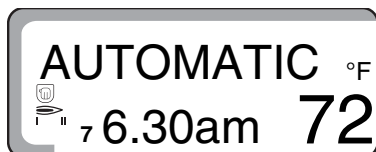
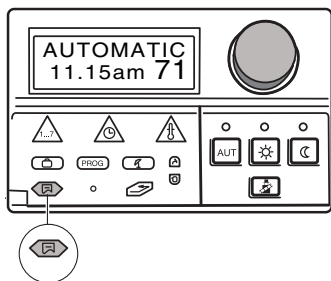

Select which value the controls should display as default.

The factory setting is:

"AUTOMATIC", time, day, current set room temperature for heating zone 1.

This standard display can be changed to one of the following:

- Boiler water temperature
- DHW temperature
- Outdoor temperature (current value)
- Collector temperature if the solar module (FM 244) is installed.

Each of the standard displays contains additional symbols that indicate the current operating status of your heating system, e.g.:



Circulating pump for heating zone 1 running.



DHW tank charging pump running.

### Changing the standard display

- Open flap.

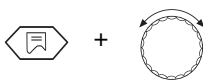

Hold down the "Display" key and turn the dial until the desired standard display appears (in this case "DHW PROD").



The display shows the current DHW temperature.

Release the "Display" key.

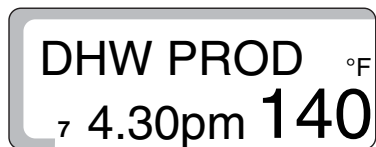

The standard display is stored.

## 7.7 Setting the day and time

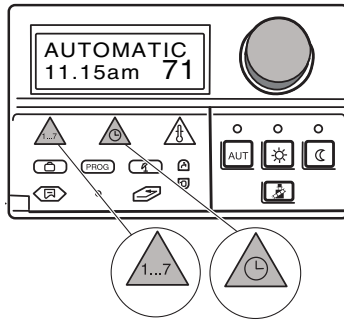

This chapter describes how to set the clock.

- Open flap

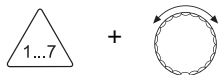

Hold down the "Day" key and turn the dial until the desired day of the week appears (in this case "1" for "MONDAY").

Release the "Weekday" key.

Monday is thus stored and is indicated by the "1".

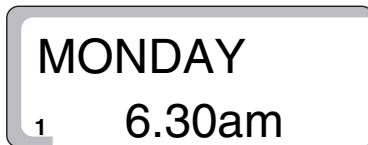

Monday = 1  
 Tuesday = 2  
 ...  
 Sunday = 7

You can now enter the time.

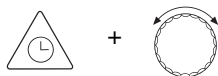

Hold down the "Time" key and turn the dial until the desired time appears (in this case "4.30pm").

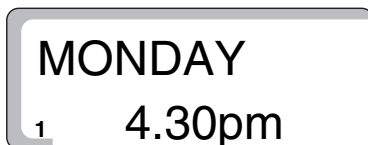

Release the "Time" key to store your input.



### USER NOTE

After a longer power failure, the "Day" and "Time" entries may flash. If the flashing display agrees with the current day and time, press the "Time" key once.

If this is not the case, please enter the time manually as described above.

## 7.8 Daylight savings time

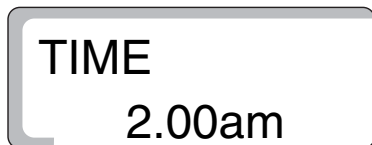
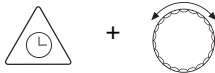
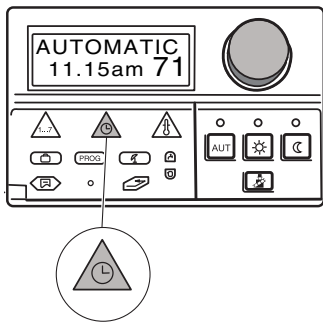

To adjust the time for daylight savings time, follow below procedure:

- Open flap.

Hold down the "Time" key and turn the dial 1 hour to the right or left, depending on whether you wish to turn daylight savings time ON or OFF. In the spring turn the clock forward, in the fall turn it back.

Release the "Time" key.

The time has now been saved.



## 8 BFU remote control

A BFU (accessory) remote control allows you to easily control your heating system from your living space.

### 8.1 General information on the BFU

The remote control is equipped with different functions.

If the vacation program is active, only the "AUT" key LED lights up.

For the room temperature control to work perfectly, all the thermostatic valves in the room containing the remote control or the external room temperature sensor must be fully open at all times.

The remote control should not be exposed to the direct influence of other external heat sources, e.g. lamps, televisions, sunlight or open doors or windows.

### 8.2 Normal heating mode (day mode)

Set the room temperature for normal heating mode (day mode) as follows:

- Turn the dial (Fig. 11, **Item 1**) to the desired day-time room temperature, e.g. 70°F (21°C).  
The setting range is 52 – 86°F (11 – 30°C).

If your heating contractor activated the "room temperature compensation" function, any temperature fluctuations that are signaled by the room temperature sensor (in the remote control or external) to the electronic controls are automatically compensated by raising or lowering the boiler water temperature.

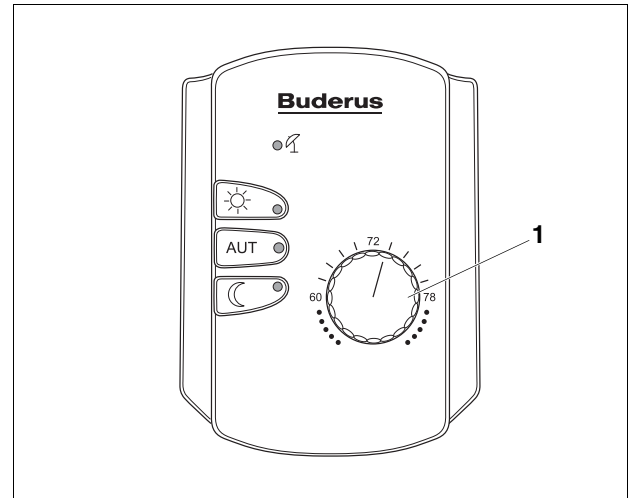

Fig. 11 Remote control

**Item 1:** Dial

### 8.3 Setback heating mode (night mode)

The setback heating mode is set as a temperature differential with respect to the normal heating mode.

This setting should be made by your heating contractor when the system is commissioned.

The setting range is 34 – 50°F (1 – 10°C).

The factory default is 7°F (4°C).

#### Example

Dial set to 70°F (21°C) daytime room temperature.  
Set temperature differential 7°F (4°C).

This gives a night-time room temperature of 63°F (17°C).

### 8.4 Key functions

The keys on the remote control can be used to set three different operating modes:

- Automatic mode
- Setback heating mode (night mode)
- Normal heating mode (day mode)

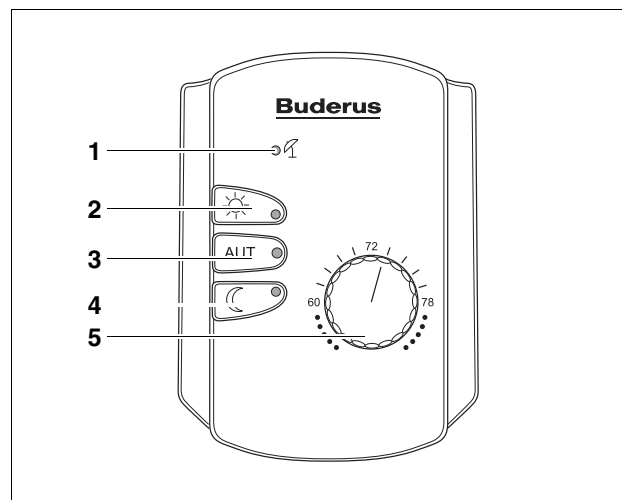

Fig. 12 Remote control

**Item 1:** "WWSD" LED

**Item 2:** "Day mode" key

**Item 3:** "AUT" key

**Item 4:** "Night mode" key

**Item 5:** Dial

### Automatic mode

In addition to the green LED over the "AUT" key, the LED over the "Day mode" or "Night mode" key also lights up, depending on which heating mode is currently selected.

If there are two heating zones present, but only one of these is equipped with a remote control, the LEDs on the controls apply to the heating zone without remote control.

Normal heating mode and setback heating mode automatically switch at the switching times set in the selected program.



Press the "AUT" key to start automatic mode.

### Manual mode

#### Normal heating mode (day mode)

Switch to manual mode in order to change the desired temperature.

Normal heating mode (day mode) is indicated by the green LED over the "day mode" key.

In this operating mode, the system is heated to the set day-time room temperature, regardless of which heating program is set.

The heating program has no effect.

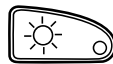

Press the "Day mode" key to start normal heating mode (day mode).

### Party function

You are having a party and want the rooms to be heated for longer.



Press the "day mode" key.



After the party, press "AUT" to return to automatic mode.

**Manual mode****Setback heating mode (night mode)**

Switch to manual mode in order to change the desired temperature.

The mode is indicated by the green LED above the "night mode" key.

In this operating mode, the system runs in setback heating mode (night mode), regardless of which heating program is set.

If both heating zones are in setback heating mode (night mode), the DHW heating is also switched off.

The heating program has no effect.

**Pause function**

You are about to leave your home for a few hours and would like to reduce the heat while you are away.



Press the "night mode" key.



On your return, press the "AUT" key.

**Summer mode**

In Summer mode, no heating takes place, but the water continues to be heated.



The LED beside this symbol lights up.



Press the "Day mode" key, if you want to heat at short notice in summer mode.



Press the "Night mode" key, if you want to interrupt summer mode. The controls will then remain constantly in Winter mode.

## 9 Advanced programming options

### 9.1 Modifying standard programs

If a standard program only partly meets your needs, you or your heating contractor can modify it. The modified standard program is stored under the name "OWN PROGRAM".

A standard program is determined by switching points, and each switching point is defined by three things: "Day", "Time" and "Temperature". The higher temperature set corresponds to "Day mode ON", while the lower value equates to "Night mode OFF". The switching points indicate the start and end of normal heating mode (day mode).

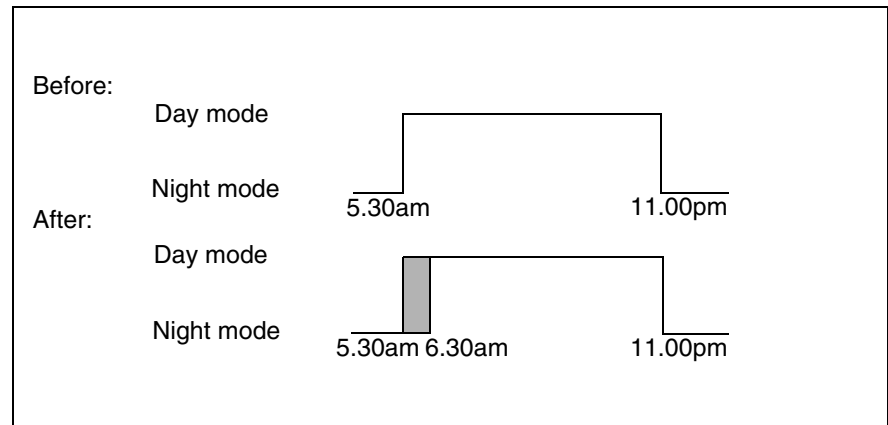
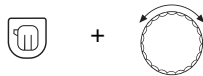
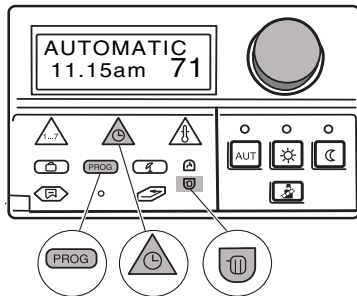

Fig. 13 Changing the switching point

#### Example

In the Family program, we are moving the heating ON time for heating zone 2 on Monday from 5.30am to 6.30am (Fig. 13).



Hold down the "Heating zone" key and turn the dial until "CIRCUIT 1" is displayed.

Release the "Heating zone" key.

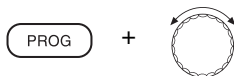

Hold down the "PROG" key and turn the dial until the desired standard program (in this case "FAMILY") is displayed.

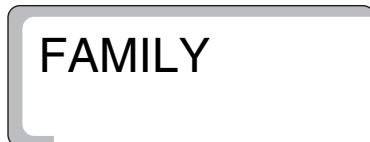

The "FAMILY" standard program has now been selected.

Release the "PROG" key.

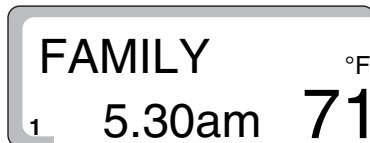

The display shows the first switching point for the "FAMILY" standard program (in this case "5.30am").



Hold down the "Time" key and turn the dial to the desired value (in this case "6.30am").

Release the "Time" key to store your input.

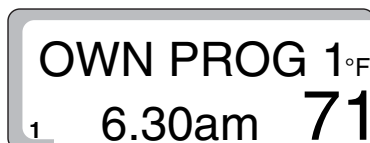

"OWN PROG 1" is now displayed since you have changed the standard program into a customized program.

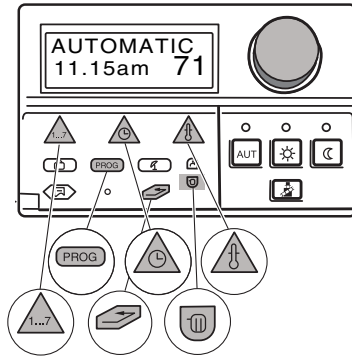

### Inserting a switching point

You can insert switching points (specifying the day, time and temperature) to an existing heating program in order to interrupt a heating phase, for example.

### USER NOTE

Make sure that you always enter alternating ON and OFF points.

### Example

In the "FAMILY" program for heating zone 1 you also want to switch the heating off on Friday (day 5) from 10.00am – 1.00pm.

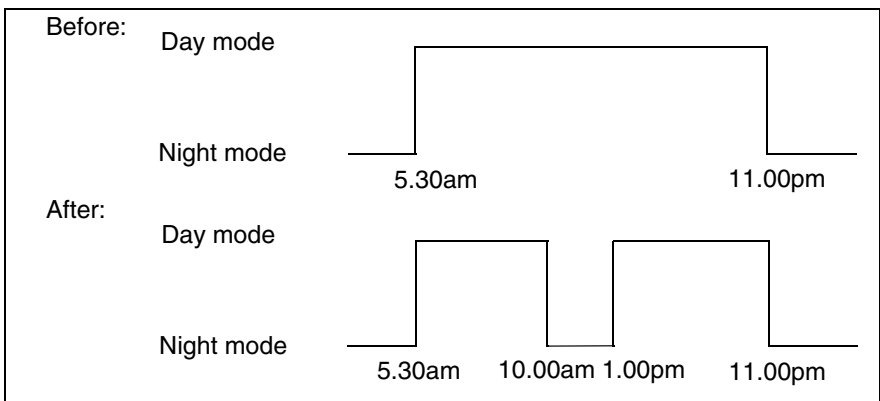
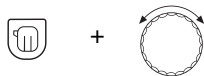

Fig. 14 Entering a switching point

- Open flap.



Hold down the "Heating zone" key and turn the dial until "CIRCUIT 1" appears.

Release the "Heating zone" key.

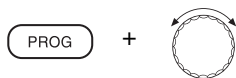

Hold down the "PROG" key and turn the dial until the desired standard program (in this case "FAMILY") is displayed.



The "FAMILY" standard program has now been selected.

Release the "PROG" key.

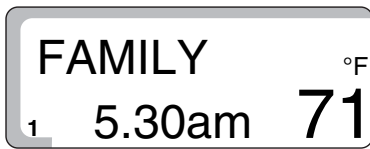

The display shows the first switching point for the "FAMILY" standard program.



Turn the dial counter-clockwise, until "NEW SP" is displayed.

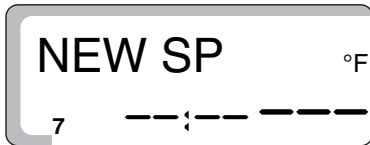

+



Hold down the "Day" key and turn the dial until the desired day of the week 1 ... 7 appears, e.g. "5" for Friday.

Release the "Weekday" key to store your input.



+



Hold down the "Time" key and turn the dial until the desired time for the new switching point appears, e.g. "10.00am".

Release the "Time" key to store your input.



+



Hold down the "Temp" key and turn the dial until the desired operating mode appears, e.g. "63°F" (17°C) for setback mode or "71°F" (21°C) for normal heating mode.

Release the "Temp" key to store your input.

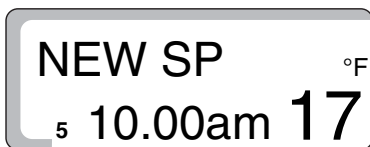

The display shows "NEW SP". You have now entered a new switching point at which the heating will be lowered / switched off.

You must then enter the switching point for switching back on again.



#### USER NOTE

Enter the switching point for switching the heating system back on again in the order described above (specifying the day, time and temperature).



Press "Back". Your input is stored under "OWN PROGRAM 1".



#### USER NOTE

The switching point can still be changed while dashes appear on the display. The new switching point is not stored until you release the "Temp" key.



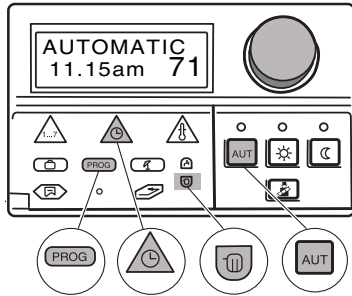

### Deleting a heating phase

A heating phase consists of two switching points, e.g. a start and a stop time. If you wish to delete a heating phase, you will have to delete both switching points.

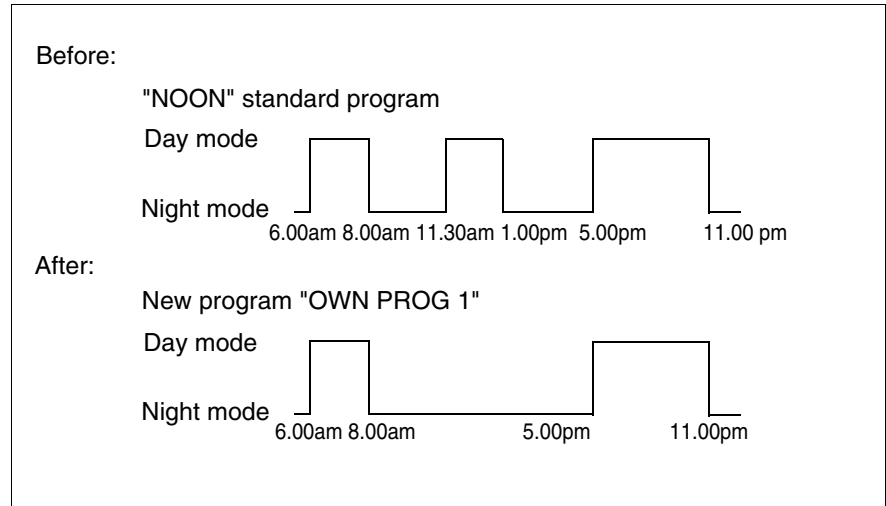
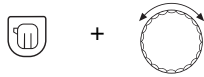

Fig. 15 Deleting a heating phase

### Example

Starting from the "NOON" standard program, you wish to delete the heating phase on Monday from 11.30am – 1.00pm so that there is a heating pause from 8.00am – 5.00pm:

- Open flap.



Hold down the "Heating zone" key and turn the dial until "CIRCUIT 1" is displayed.

Release the "Heating zone" key.

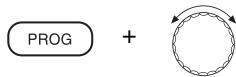

Hold down the "PROG" key and turn the dial until the desired standard program (in this case "NOON") is displayed.



The "NOON" standard program has now been selected.

Release the "PROG" key.

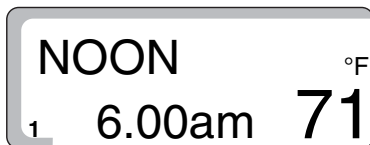

The display shows the first switching point for the "NOON" standard program (in this case "6.00am").



Turn the dial until the switching point of the heating phase that you wish to delete is displayed, e.g.: "11.30am".

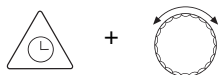

Hold down the "Time" key and turn the dial to the desired value (in this case "1.00pm").

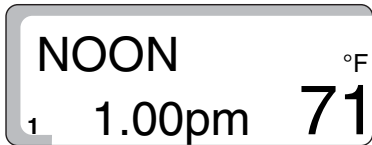

The switching point cannot be turned any further since another switching point is programmed at 1.00pm.

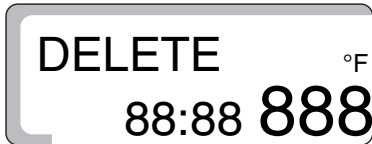

Once you have turned to the "1.00pm" switching point, the display changes to "DELETE" and an "8" appears for each numerical value in the display. Each "8" disappears after a short time.

Once all eight have disappeared, you can release the "Time" key. The two switching points "11.30am" and "1.00pm" are deleted and the new program is stored under "OWN PROGRAM 1".



#### USER NOTE

labelling the deletion

Release the "Time" key before all the eights have disappeared. The switching points of the heating phases are retained.



Press the "AUT" key to return to the standard display.

## 9.2 Connecting heating phases

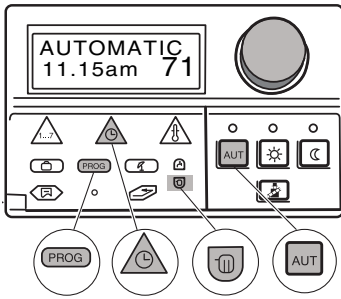

A heating phase consists of a switch ON point and a switch OFF point. To connect two consecutive heating phases, set the switch OFF time of the first heating phase to the switch ON time of the next heating phase.

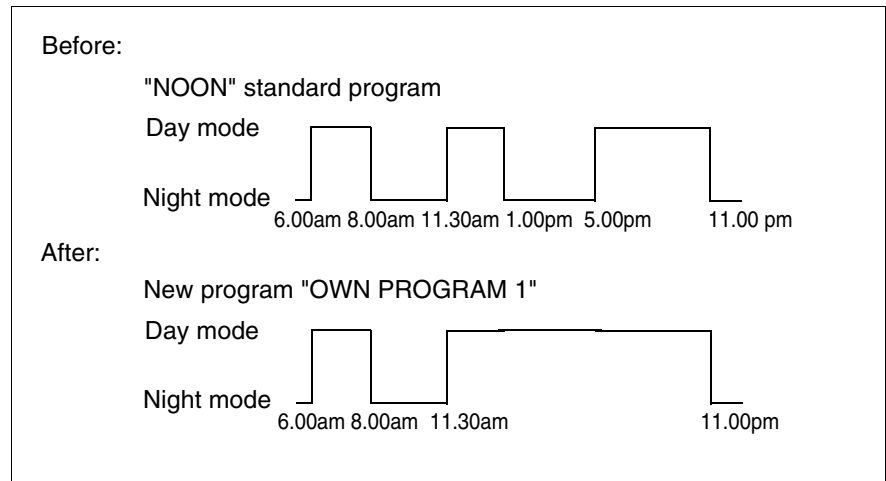
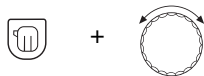

Fig. 16 Connecting heating phases

### Example

Starting from the "NOON" standard program, you wish to connect the heating phase on Monday from 11.30am – 1.00pm to the heating phase from 5.00pm – 11.00pm. This means that you wish to heat continuously from 11.30am to 11.00pm.

- Open flap.



Hold down the "Heating zone" key and turn the dial until "HEAT CIRC 1" is displayed.

Release the "Heating zone" key.

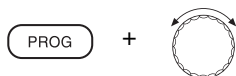

Hold down the "PROG" key and turn the dial until the desired standard program (in this case "NOON") is displayed.

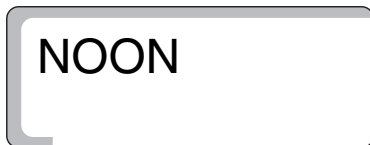

The "NOON" standard program has now been selected.

Release the "PROG" key.

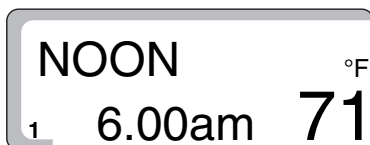

The display shows the first switching point for the "NOON" standard program.



Turn the dial until the switching point of the heating phase that you wish to connect to another is displayed (in this case "1.00pm").



+



Hold down the "Time" key and turn the dial to the desired value (in this case "5.00pm").

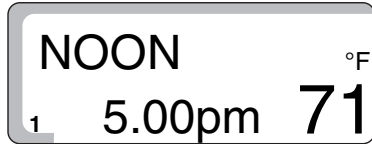

The switching point cannot be turned any further since another switching point is programmed at 5.00pm.

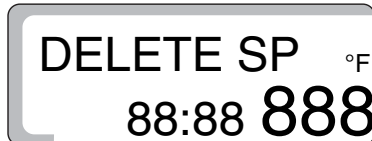

Once you have turned to the "5.00pm" switching point, the display changes to "CONNECT" and an "8" appears for each numerical value in the display. Each "8" disappears after a short time.

Once all eight have disappeared, you can release the "Time" key. The two switching points "1.00pm and 5.00pm are deleted and the new program is programmed with a continuous heating phase from "11.30am – 11.00pm" and stored under "OWN PROGRAM 1".



#### USER NOTE

Cancelling the deletion

Release the "Time" key before all the eights have disappeared. The switching points of the heating phases are retained.

Press the "AUT" key to return to the standard display.

### 9.3 Creating a new heating program

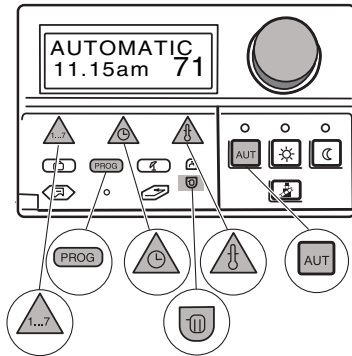

You can also set up a new heating program that is tailored entirely to your personal requirements. The new heating program is stored under the name "OWN PROGRAM 1".

#### Enter switching points for, in this case "Monday".

Make a note of your custom program.

- Open flap.

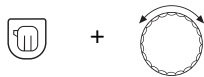

Hold down the "Heating zone" key and turn the dial until "CIRCUIT 1" is displayed.

Release the "Heating zone" key.

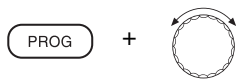

Hold down the "PROG" key and turn the dial until the "NEW" standard program is displayed.

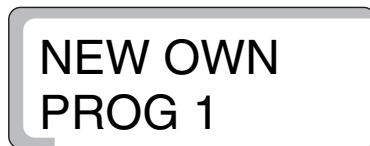

The "NEW" standard program has now been selected.

Release the "PROG" key.

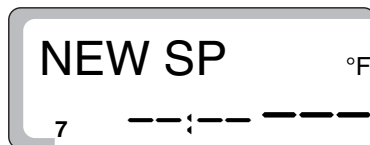

"NEW SP", dashes and "7" for Sunday, for example, immediately appear in the display.

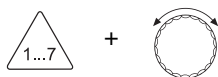

Hold down the "Day" key and turn the dial until the desired day of the week 1 ... 7 appears, e.g. "1" for Monday.

Release the "Weekday" key.

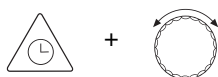

Hold down the "Time" key and turn the dial until the desired time for the new switching point appears, e.g. "5.00am".

Release the "Time" key.

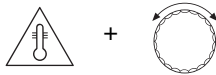

Hold down the "Day" key and turn the dial until the room temperature for normal heating mode appears, e.g. "71°F" (21°C).

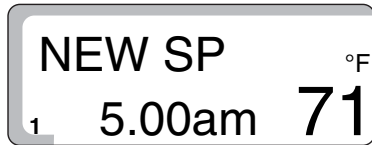

Release the "Temp" key. The switching point is stored.

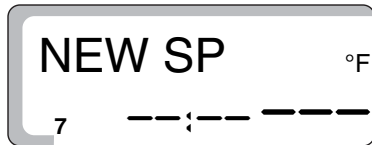

The switching point is stored under "OWN PROG 1" for heating circuit 1. "NEW SP", dashes and "7" for Sunday, for example, immediately appear in the display.



#### USER NOTE

Enter all the other the switching points for other days in the order described above (specifying the day, time and temperature).



Press the "AUT" key to return to the standard display.

## 10 Troubleshooting

If faults occur in the heating system, they are displayed on the controls.

You can remedy some faults yourself (see chapter "Fault table" page 56). You may have to switch the heating system to emergency mode (see chapter 11 "Operation in the event of a fault" page 58).

If you cannot remedy the fault yourself, please follow these instructions:

- Check whether there is a fault message on the controls' display.
- Report the fault initially by telephone to your heating contractor.  
Have the faults remedied by your heating contractor immediately.

## Fault table

Fault message	Effect	Remedy
BURNER ERR	Burner system fault – The heating stays cold	Reset the burner as described in the boiler or burner documentation.
HEATING ERR	– The heating system stays cold – The boiler stays cold. – The electronic circuit is faulty. – The boiler water thermostat is set too low. – The high limit safety cut-out has responded.	<ul style="list-style-type: none"> <li>● Consult your local heating contractor.</li> </ul>
DHW PROD ERR	DHW – No domestic hot water. available.	<ul style="list-style-type: none"> <li>● On the controls, switch the emergency mode switch to "Manual". In emergency mode, the heating system works without the electronic program. The boiler water temperature determines the DHW temperature. The DHW priority circuit has not effect.</li> <li>● Turn the boiler water thermostat to 140°F (60°C).</li> <li>● Consult your local heating contractor.</li> </ul>

**WARNING!****RISK OF SCALDING**

The DHW temperature can be set to a maximum of 194°F (90°C). At DHW temperatures over 122°F (50°C) there is a risk of scalding at the taps if the DHW line has no thermostatic mixing valve installed.

- If the DHW temperature is set to above 122°F (50°C), you should only draw off mixed hot and cold water.

**USER NOTE**

No DHW can be produced if the DHW tank charging pump is defective, even in "emergency mode".



Fault message	Effect	Remedy
REMOTE 1 ERR or REMOTE 2 ERR	Remote control faults – The controls cannot communicate with the (relevant) remote control. – The controls is working with the set default values.	<ul style="list-style-type: none"> <li>● Consult your local heating contractor.</li> </ul>
BLR SENSR ERR OA SENSOR ERR DHW SENSR ERR MIX SENSR ERR SL SENSOR ERR DHW SLR ERR	Temperature sensor is defective – A defective temperature sensor is displayed. – For safety reasons, no hot water will be produced if the DHW sensor is faulty.	<ul style="list-style-type: none"> <li>● Consult your local heating contractor.</li> </ul>
The following displays appear when the controls can no longer detect a previously detected module:  FM 241 ERR  FM 242 ERR  FM 244 ERR	No module functions present.  Error message for mixer module (FM 241).  Error message for burner module (FM 242).  Error message for solar module (FM 244).	<ul style="list-style-type: none"> <li>● Consult your local heating contractor.</li> </ul>

**Power failure**

The system remains non-operational for the duration of a power failure and starts up again automatically when the power is restored. All the controls settings and programs are permanently stored. After longer power failures, the day and time flash on the display and must be checked (clock power reserve: approx. 5 – 8 hours).

If the power reserve is exhausted, the display jumps to Monday, 12.00am.

# 11 Operation in the event of a fault

If there is a fault in the controls, you may continue to run your heating system temporarily.

**RISK TO LIFE**  
from electric shock.

**WARNING!**

- Never open the controls.
- Never attempt to dismantle individual components.

- Check whether individual controls are set incorrectly before making the settings for emergency mode.
- Depending on the fault, set the emergency switch and the controls as shown in the following table (Tab. 2).
- Boiler water thermostat (Fig. 17, **Item 1**)
- Emergency mode, heating and DHW switches (Fig. 17, **Item 2**).
- Set the On/Off switch to the **I** position (Fig. 17, **Item 3**).

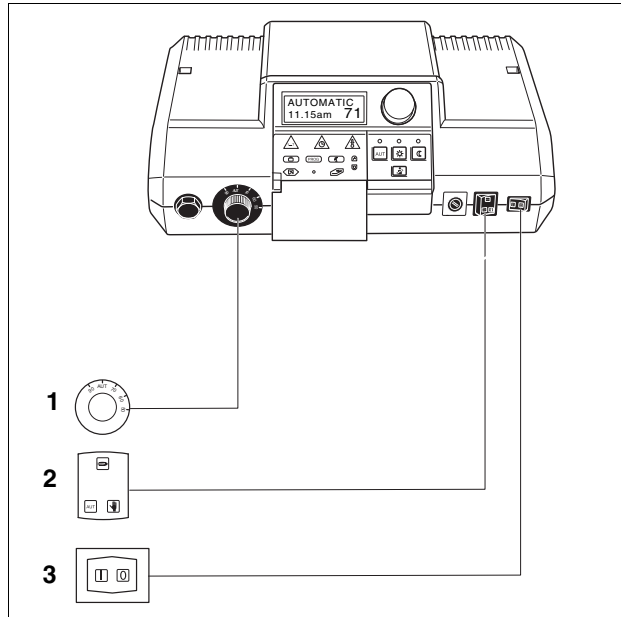

Fig. 17 Check the settings of the controls

**Item 1:** Boiler water thermostat

**Item 2:** Emergency mode, heating and DHW switches

**Item 3:** ON/OFF switch

Fault	Settings for an emergency operation		
	ON/OFF switch	Manual Emergency mode Boiler circuit and DHW	Boiler water thermostat
Central heating failed	I	Hand icon <sup>1)</sup>	140 – 194°F (60 – 90°C)
DHW heating failed	I	Hand icon <sup>1)</sup>	140°F (60°C)
Central heating and DHW heating failed	I	Hand icon <sup>1)</sup>	140°F (60°C)

Tab. 2 Emergency mode settings

<sup>1)</sup> If a mixer is installed for heating circuit 2, the mixing valve must be set manually in emergency mode so that overheating (underfloor heating) is prevented.

In the event of faults, immediately notify your heating contractor. It would be helpful for your heating contractor if you could provide him with precise details about the fault.



#### Operation

In manual mode, the pumps for the heating circuit(s) and the DHW tank filling pump are switched on **constantly**. The recirculation pump remains switched OFF.



#### WARNING!

#### RISK OF SCALDING

The DHW temperature can be set to a maximum of 194°F (90°C). At DHW temperatures over 122°F (50°C) there is a risk of scalding at the taps if the DHW line has no thermostatic mixing valve installed.

- If the DHW temperature is set to above 122°F (50°C), you should only draw off mixed hot and cold water.

## 12 Setup report

### Operating values

	Input range	Factory setting	Your setting
Factory set programs	FAMILY EARLY LATE PM HOME AM HOME NOON SINGLE NEW CUSTOM	FAMILY	
DHW	86 – 194°F (30 – 90°C)	140°F (60°C)	
Warm weather shutdown (WWSD) Constant summer Constant winter	50 – 86°F (10 – 30°C)	63°F (17°C)	
Day room temperature	52 – 86°F (11 – 30 °C)	71°F (21°C)	
Night room temperature	50 – 84°F (10 – 29°C)	63°F (17°C)	
Vacation room temperature	50 – 86°F (10 – 30 °C)	63°F (17°C)	

## 13 Flue gas test

The flue gas test must only be carried out by a heating contractor. It is carried out once a year during the annual service.

The individual heating zones then pass their maximum possible demand to the boiler. With the pumps switched off, the boiler is brought as rapidly as possible to the supply temperature required for the tests (current boiler water temperature shown in display) and attempts are then made to maintain this temperature without turning the burner off while switching on additional consumers. This has the effect of extending the test periods as long as possible.

The ON/OFF switch on the control device must be ON.



Push the "Flue gas test" button once and hold down for 1 second.

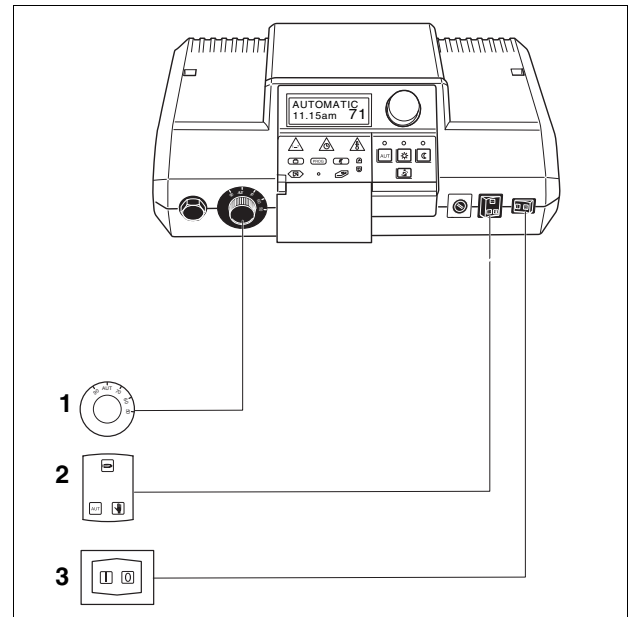

Fig. 18 Checking control settings

**Pos. 1:** Boiler water thermostat

**Pos. 2:** Emergency operation, heating and DHW switches

**Pos. 3:** ON/OFF switch

"BRNR TEST" and the boiler water temperature appear in the display.

After 30 minutes the control device reverts automatically to the mode it was in prior to the test.

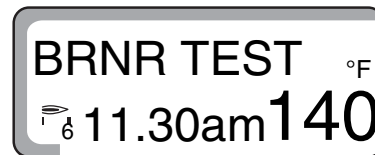

### Interrupting the flue gas test



Push the "Flue gas test" button again and hold down for 1 second.



**WARNING!**

#### RISK OF SCALDING

Do not open any hot water tap without mixing in cold water, if the DHW circuit of your heating system is not equipped with a thermostatic mixer!

## 14 Keyword index

<b>A</b>		
Automatic mode	. . . . .	.23, 42
<b>B</b>		
BFU remote control	. . . . .	.41
Boiler	. . . . .	7
Brief description	. . . . .	5
<b>C</b>		
Changing the switching point	. . . . .	.46, 47
Connecting heating phases	. . . . .	.51
Controls	. . . . .	.14
<b>D</b>		
Day mode	. . . . .	.11
Daylight savings time change	. . . . .	.40
Deleting a heating phase	. . . . .	.49
DHW	. . . . .	.26
DHW recirculation pump	. . . . .	.26
DHW continuous mode	. . . . .	.37
DHW tank	. . . . .	7
Dial	. . . . .	.15
Domestic hot water thermostat	. . . . .	.26
<b>E</b>		
Emergency mode	. . . . .	.58
<b>F</b>		
Factory setting	. . . . .	.27, 60
Faults	. . . . .	.58, 61
Flue gas test	. . . . .	.61
Frost protection	. . . . .	.20
<b>H</b>		
Heating controls	. . . . .	7
Heating mode	. . . . .	.41
Heating mode set back	. . . . .	.42
Hours run	. . . . .	.21
<b>I</b>		
Initial start-up	. . . . .	.19
<b>K</b>		
Key functions	. . . . .	.22
<b>M</b>		
Manual mode	. . . . .	.59
<b>N</b>		
Night mode	. . . . .	.11
<b>O</b>		
Operating mode, heating mode	. . . . .	.23, 24
Operating values	. . . . .	.60
<b>P</b>		
Party function	. . . . .	.43
Pause function	. . . . .	.44
Pipes	. . . . .	7
Power failure	. . . . .	.58
Power loss	. . . . .	.61
Program selection	. . . . .	.32
<b>R</b>		
Radiators	. . . . .	7
Room temperature	. . . . .	24
<b>S</b>		
Setting automatic mode	. . . . .	37
Setting the day and time	. . . . .	39
Setting the time	. . . . .	39
Setup report	. . . . .	60
Shutting down	. . . . .	20
Solar automatic	. . . . .	28
Solar heating system	. . . . .	28
Solar manual	. . . . .	29
Solar OFF	. . . . .	29
Standard program	. . . . .	30
Summary of standard programs	. . . . .	31
Summer mode	. . . . .	35
Switching off DHW heating	. . . . .	37
<b>T</b>		
Thermostatic radiator valve	. . . . .	8
<b>W</b>		
Warm weather shutdown (WWSD)	. . . . .	35
Winter mode	. . . . .	35



United States and Canada

Bosch Thermotechnology Corporation  
50 Wentworth Avenue  
Londonderry, NH 03053  
U.S.A.  
Tel. 603-552-1100  
Fax 603-584-1681  
[www.buderus.net](http://www.buderus.net)

Products manufactured by  
Bosch Thermotechnik GmbH  
D-35573 Wetzlar  
[www.buderus.de](http://www.buderus.de)

Bosch Thermotechnology Corporation reserves the right to make changes without notice due to continuing engineering and technological advances.

**Buderus**