

Emax Air Dryer

REFRIGERATED TYPE COMPRESSED AIR DRYERS

EDRCF1150029 – EDRCF4602000

Rev No:0

Instructions Manual

TABLE OF CONTENTS

1. Important safety notes - Please read	1
1.1. Transportation.....	1
1.2 Positioning	1
1.3 Installation.....	1
1.4 Before operating	1
1.5 Maintenance by an engineer	1
1.6 Maintenance by the user.....	1
2.Introduction	2
3.Operation	4
4.Technical specifications	7
5.Diagrams	8
6.General Arrangements	18
7. Main Settings	18
8.Drawings	19
9.Components location	60
10.Troubleshooting	61
11. Warranty	63

I. IMPORTANT SAFETY NOTES – Please READ

- A)** When operating the air dryer the operator must apply safe working methods and observe all local safety instructions and relevant regulations.
- B)** Prior to installation, the dryer and the compressed air system are to be depressurized and disconnected from the electrical main supply.
- C)** The user is responsible for safe operating conditions. Parts and accessories must be replaced if inspection shows that safe operation cannot be assured.
- D)** Installation, operation, maintenance and repair are only to be authorized, trained and skilled engineers.
- E)** The minimum and maximum values stated must be observed, as well as all of the safety precautions described in this manual.
- F)** If any statement in this manual does not comply with the local legislation, the strongest standard is to be applied.

1.1. Transportation

- A)** Use care and caution when transporting the dryer. Avoid dropping and other physical abuse.
- B)** A forklift can be used to transport the dryers provided the forks are long enough to support its full width or length and caution is used throughout the move.

1.2. Positioning

- A)** The dryer must be installed horizontally. A minimum of 20" clearance around the dryer is necessary to allow a good ventilation and easy access for servicing.
- B)** The ambient temperature in the room should not exceed 122°F and should not be below 39°F, taking the heat radiated by the dryer into account.
- C)** (40 watt for each liter/sec under ISO 7183-A condition or 18 watts for each SCFM under ISO 7183-B condition).

1.3. Installation

- A)** In addition to the general mechanical construction procedures and local regulations, the following instructions need to be emphasized:
 - 1) Only authorized, trained and skilled engineers should install the compressed air dryer.
 - 2) Safety devices, protecting covers or insulation in the dryers never to be dismantled or modified. Each pressure vessel or accessory installed outside the dryer with air above atmospheric pressure must be fitted with the required pressure relief safety valves.

1.4. Before Operating

- A)** Review all safety precautions.
- B)** The piping must have the correct diameter and be adapted to the operating pressure (see technical specification).
- C)** Never operate the dryer at pressure above the maximum specified on the dryer label (check the technical specs too).

1.5. Maintenance by an Engineer

- A)** Maintenance and repairs should only be performed when the air dryer is shut down and depressurized and when the main power switch is turned off.
- B)** Use only the appropriate tools for maintenance and repair.
- C)** Before dismantling a part under pressure, disconnect the pressure sources and depressurize the system.
- D)** Proceed carefully during maintenance and repair. Prevent dirt from entering by covering parts and orifices with a clean cloth, paper or tape. A receiver should never be welded or modified in any way.
- E)** Never leave tools, loose parts or cleaning rags in or on the air dryer.
- F)** Before returning the dryer into service, check the setting of the control and safety devices as well as the pressure and the temperature of the compressed air circuit.

1.6. Maintenance by the user

- A)** Keep the dryer clean.
- B)** Regularly check the correct operation of the condensate drain trap.
- C)** Every six months, check and clean the drain strainer by undoing the access screw and rinsing the filter with tap water to remove the trapped dirt from the inside.

- D) For air cooled dryers, clean the air condenser as soon as it's dirty or clogged.
- E) For optional water-cooled condensers, use only clean water and install a water filter if needed. Use water counter flow to clean condenser if need.
- F) Check the trouble-shooting list in case of maintenance troubles.
- G) Check operating pressures, temperatures and time settings after maintenance. If operating and safety devices function properly, the air dryer may be used.

2. INTRODUCTION TO THE DRYER

A) Manufacturer:

B) Purpose of this dryer

- 1) This refrigerated compressed air dryer has been designed to remove water vapor from industrial compressed air.
- 2) This dryer has been designed for indoor operation.
- 3) The minimum and maximum values stated must be observed, as well as the safety precautions described in this manual.

C) Dryer label

The following label is affixed on the cabinet of the refrigerant compressed air dryer.

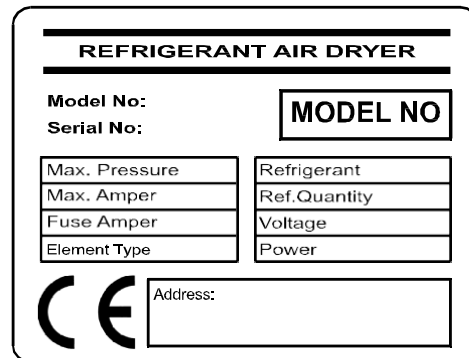

D) Working details

1) Refrigerant circuit:

The refrigerant circuit can be divided in 3 parts:

- a) Low pressure section with an evaporator (heat exchanger)
- b) High-pressure section including: Condenser, liquid receiver, (if installed) and the filter dryer.
- c) Control circuit including: Compressor, Expansion valve, by-pass valve (if installed), Fan pressure switch (if installed)

2) For water - cooled dryers:

- a) Water valve
- b) Safety high pressure switch (if installed)

3) The Refrigerant circuit operates as follows:

- a) The compressor compresses gaseous refrigerant to a high temperature.
- b) The hot refrigerant condenses in the condenser. Being liquefied it is stored in the liquid receiver (if installed).
- c) The liquid is taken out the storage vessel and injected in the evaporator (heat exchanger) by an expansion valve. This expansion valve is protected by a filter, which removes particles and humidity that could be in the circuit.
- d) The injected liquid fills in the refrigerant section of the air / refrigerant heat exchanger and evaporates by taking out the calories from the compressed air. The gaseous refrigerant is sucked in the compressor and the cycle carries on.
- e) In order to keep the evaporation pressure steady, and thus the refrigerant temperature in the heat exchanger, a by-pass valve is injecting hot gaseous refrigerant in the circuit. On certain dryers, an automatic expansion valve regulates this.

4) Compressed air circuit

- a) The saturated hot compressed air flows into the Economiser where it is pre-cooled by the out flowing dry chilled air. In the cold zone of the air refrigerant section it continues to cool

down to dew point and enters the separator where condensates are collected. The outgoing chilled air is then warmed up in the economizer by the hot incoming air.

- b) The condensates are collected after centrifugal separation and drained out through the automatic trap.
- c) As long as the compressed air temperature does not drop below dew point, there will be no condensation in the air circuit.

5) Refrigerant compressor

Being of the hermetic type, it requires no servicing.

6) Condenser

- a) The air condensers are equipped with a helicoidal at the condenser refrigerant level. On certain type of dryers, a water-cooled condenser can be fitted.
- b) In this case, a water valve being driven by the refrigerant circuit is taking care of its regulation.

7) Refrigerant circuit protection

- a) **Klixon:** The single phase compressors are equipped with a klixon which is a thermal sensitive switch controlling the temperature of the compressor and possible over intensity. In case of malfunction, the klixon trips but switches on again automatically as soon as the compressor has cooled down.
- b) **High Pressure Security Switch:** Refrigerant line is considered as a pressure vessel. That is why it is protected against bursts by the help of manually reset switch. It is set to 362.5 psi for dryers working with R134a
- c) **Filter dryer:** A refrigerant circuit is a closed circuit and total water removal in the refrigerant circuit is paramount in order to obtain a correct functioning.
- d) To avoid problems, the refrigerant circuit must be vacuumed before loading the refrigerant. It is equipped with a filter dryer, which also traps any solid particles, which may have migrated into the circuit during assembly.
- e) Water-cooled dryers have a safety high-pressure switch. In case of cooling water failure, the safety switch stops the dryer. When the safety switch has tripped out, it has to be manually resettled before switching on the dryer.

8) Refrigerant circuit controls

- a) Liquid refrigerant injection: The liquid refrigerant is into the evaporator by a control valve. This valve is a thermostatic or pressostatic one maintaining a constant overheats of the refrigerant in the evaporator(s).
- b) Constant evaporating pressure: In the dryers equipped with a by-pass valve, the evaporating pressure is kept constant by a controlled injection of hot gas from the high-pressure side into the low-pressure section of the circuit.

9) Condensate drain - trap assembly

Dismantling the drain is easy because it can be isolated from the air circuit under pressure with a ball valve. The drain has to be depressurized before being dismantled.

10) Heat Exchanger Modular design

- a) The dryers are equipped with a compact Mono Bloc Heat Exchanger module. This assembly has been specially designed to dry compressed air and is made of:
 - 1) An Economiser which pre-cools the entering hot air with the out flowing cold air.
 - 2) An air/refrigerant exchanger cooling down the compressed air.
 - 3) A centrifugal separator concentrating all condensates and requiring no maintenance.

11) Accessories

- a) Dew point indicator: Located on the control panel, it displays the value of the pressure dew point.
- b) Temperature switch: Located inside the dryer, this temperature switch is adjustable from 32 °F up to 95 °F
- c) Energy Saving Device: (ESD) This device helps dryer save energy when there is not any compressed air flow in the dryer. (Please see the models have standart and optional in next page)
- d) Filter change alarm on the front panel

3. OPERATION

3.1. Operation

A) Control panels: The control panel of the dryer includes the following elements:

Monophase	Dew point indicator
PDRCF1150029 - PDRCF2300288	●

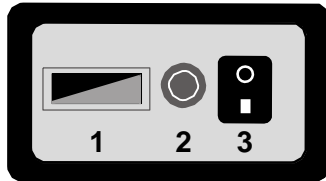

- 1) Dewpoint indicator (Standard)
- 2) Filter change Alarm**
- 3) Start / Stop Button

Monophase	Dew point indicator
DN120-US - DN130-US	●

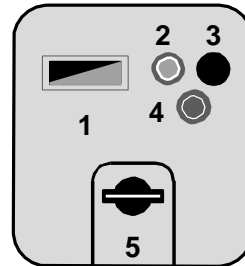

- 1) Dewpoint indicator (Standard)
- 2) Start Light
- 3) N/A
- 4) Filter change Alarm**
- 5) Main Switch

Triphase	ESD3
PDRCF4600575 - PDRCF4601200	●

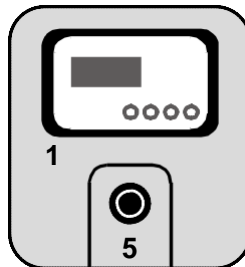

- 1) ESD3 (Standard)
- 5) EMERGENCY STOP

**** IMPORTANT NOTE:** The Dryer has two Compressed Air Filter inside. It is better to change filter element for the best efficiency when the alarm light is active. It is recommended to keep replacement filter elements in your stock in order to replace them when needed.

ATTENTION : DN-US range dryers have low pressure drop according its competitors. Do not use DN-US range dryers together with other dryers which have higher pressure drop without getting the confirmation from our technical team.

3.2. During Operation

Regularly check the digital temperature controller ESD3 or dew point indicator on dryer.

B) Start up and shut-down

Warning: Avoid leaving the dryer off when compressed air is still flowing through it.

C) Starting for the first time or after a long stop

1) Set the rotary switch to "1" This preheats the dryer and turns the drain system on.

It is recommended to leave the dryer power on permanently so the crankcase heater runs continuously.

2) **IMPORTANT NOTE!**

After a long stop of the dryer it is **MANDATORY** to allow a preheating period of minimum **4 hours** before starting again, to avoid any compressed air flow during preheating.

3) Follow the daily starting and shut down procedure.

D) Daily starting and shut-down

1) Push on the green button to start the dryer.

2) The start light will indicate that the dryer is running.

3) To stop the dryer, first stop the airflow (either shut-down the air compressor or close the inlet/outlet or by-pass valve) When the air flow is stopped set the rotary switch on " 0 " Set it again on " 1 " in order to keep the preheating on.

4) **IMPORTANT NOTE!**

Avoid leaving the dryer stopped when compressed air is still flowing through it.

5) To switch the already preheated dryer on again, simply push the green start button.

E) Digital Temperature Control technical features (ESD3)

ESD3: PLC clear text multilingual indication of alarms, maintenance and running hours

+ Energy Saving Device automatic switching OFF at no load and ON when warm compressed air is entering.

(Please see the ESD3 manual which is given with Dryer)

Emax Air Dryer

REFRIGERATED TYPE COMPRESSED AIR DRYERS

Technical Specifications & Diagram



Model	Capacity (CFM)	Connection Size	Voltage	Total Electric Power	Refrigerant Type	Pressure Drop	Max Work pressure (bars)	Max Ambient Temperature	Max inlet Temp.
PDRCF1150029	29	1/2"	115	0.42	R134a	<3	232	122	140
PDRCF1150058	58	3/4"	115	0.68	R134a	<3	232	122	140
PDRCF1150115	115	1 1/2"	115	0.93	R134a	<3	232	122	140
PDRCF1150144	144	1 1/2"	115	1.28	R134a	<3	232	122	140
PDRCF2300288	288	2"	230	1.94	R134a	<3	232	122	140
PDRCF4600288	288	2"	460	1.94	R134a	<3	232	122	140
PDRCF4600575	575	3"	460	3.01	R134a	<3	232	122	140
PDRCF2300575	575	3"	230	3.01	R134a	<3	232	122	140
PDRCF4600850	850	3"	460	4.31	R134a	<3	232	122	140
PDRCF4601200	1200	3"	460	5.68	R134a	<3	232	122	140
PDRCF4601600	1600	3"	460		R134a	<3	232	122	140
PDRCF4602000	2000	3"	460		R134a	<3	232	122	140

For All Models	
Maximum Pressure	232 PSI
Maximum Ambient Temperature	122 F
Minimum Ambient Temperature	40F
Maximum Inlet Temperature	140 F



5.1 AIR FLOW DIAGRAMS

EDRCF1150029 - EDRCFR1150144

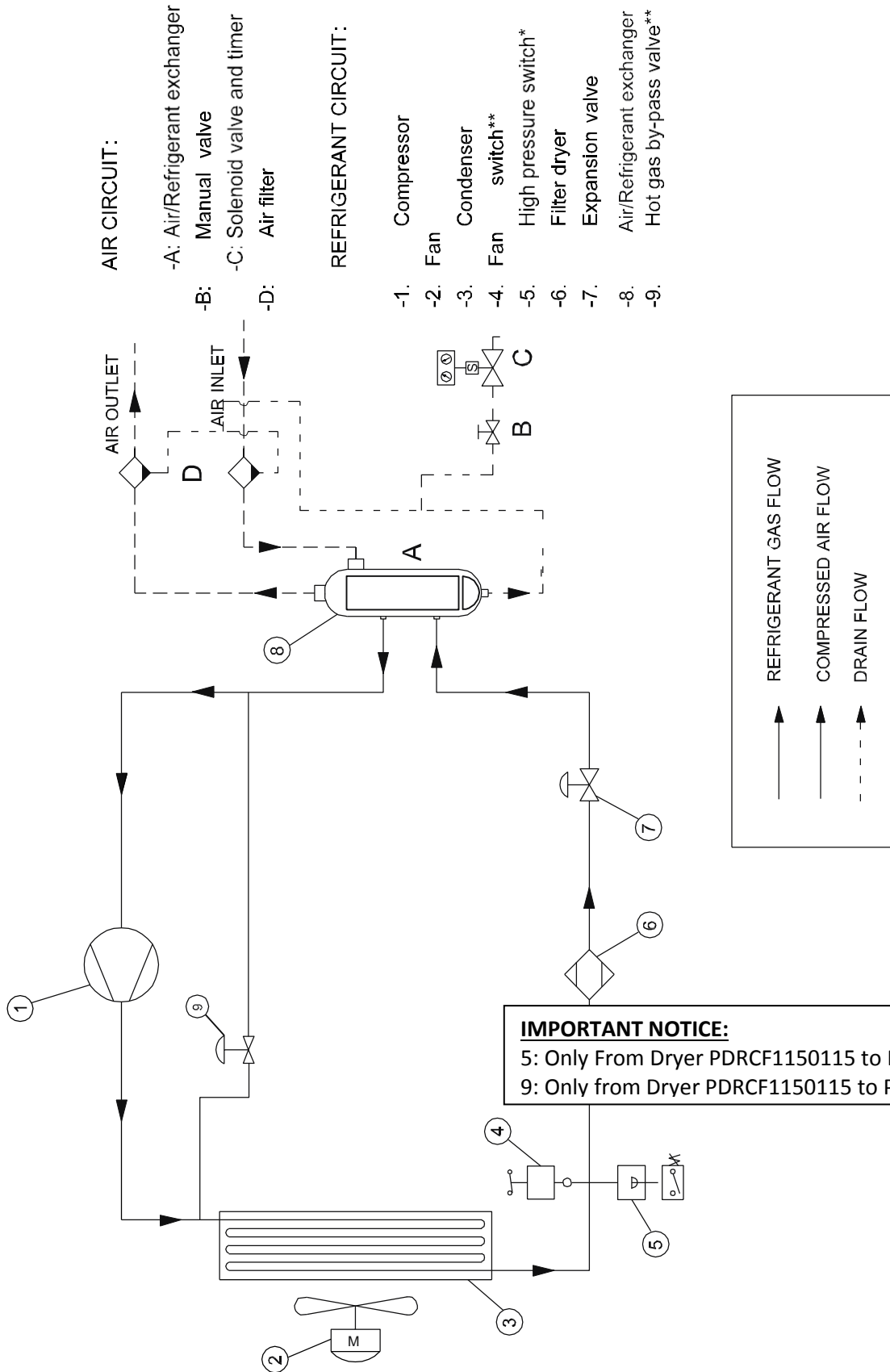

AIR CIRCUIT:

- A: Air/Refrigerant exchanger
- B: Manual valve
- C: Solenoid valve and timer
- D: Air filter

REFRIGERANT CIRCUIT:

- 1. Compressor
- 2. Fan
- 3. Condenser
- 4. Fan switch**
- 5. High pressure switch*
- 6. Filter dryer
- 7. Expansion valve
- 8. Air/Refrigerant exchanger
- 9. Hot gas by-pass valve**

IMPORTANT NOTICE:
 5: Only From Dryer PDRCF1150115 to PDRCF1150144
 9: Only from Dryer PDRCF1150115 to PDRCF1150144



Dryair DN100-US - Dryair DN170-US

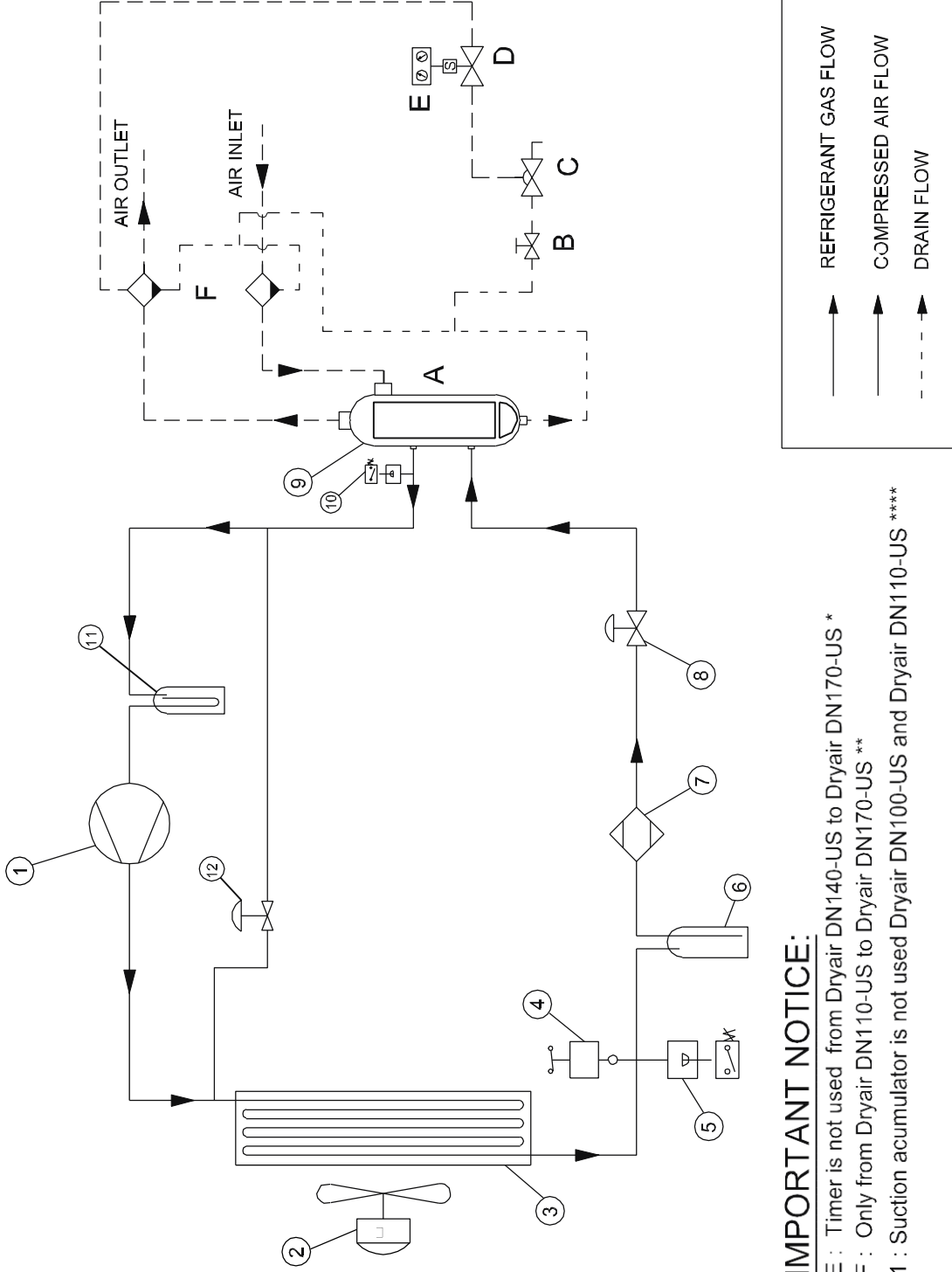

AIR CIRCUIT:

- A: Air/Refrigerant exchanger
- B: Manual valve
- C: Membrane valve
- D: Solenoid valve
- E: Timer*
- F: Air filter**

REFRIGERANT CIRCUIT:

- 1. Compressor
- 2. Fan
- 3. Condenser
- 4. Fan switch
- 5. High pressure switch
- 6. Liquid receiver
- 7. Filter dryer
- 8. Expansion valve
- 9. Air/Refrigerant exchanger
- 10. Low pressure switch
- 11. Suction accumulator****

IMPORTANT NOTICE:

- E : Timer is not used from Dryair DN140-US to Dryair DN170-US *
- F : Only from Dryair DN110-US to Dryair DN170-US **
- 11 : Suction accumulator is not used Dryair DN100-US and Dryair DN110-US ****

5.2 ELECTRICAL DIAGRAMS

Dryair DN10-US - Dryair DN30-US

Electrical Circuit

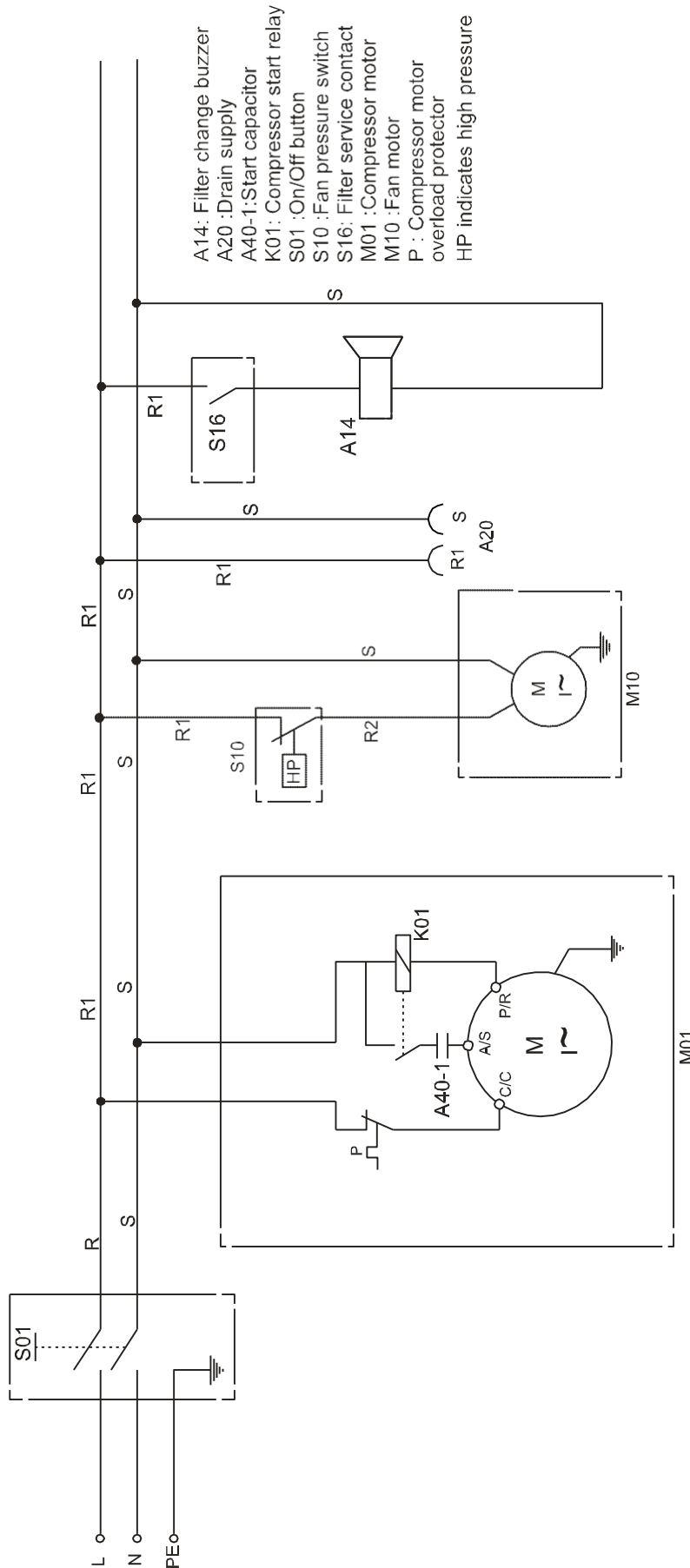

- A14: Filter change buzzer
- A20 :Drain supply
- A40-1:Start capacitor
- K01: Compressor start relay
- S01 :On/Off button
- S10 :Fan pressure switch
- S16: Filter service contact
- M01 :Compressor motor
- M10 :Fan motor
- P : Compressor motor overload protector
- HP indicates high pressure

Dryair DN100-US - Dryair DN110-US

Electrical Circuit

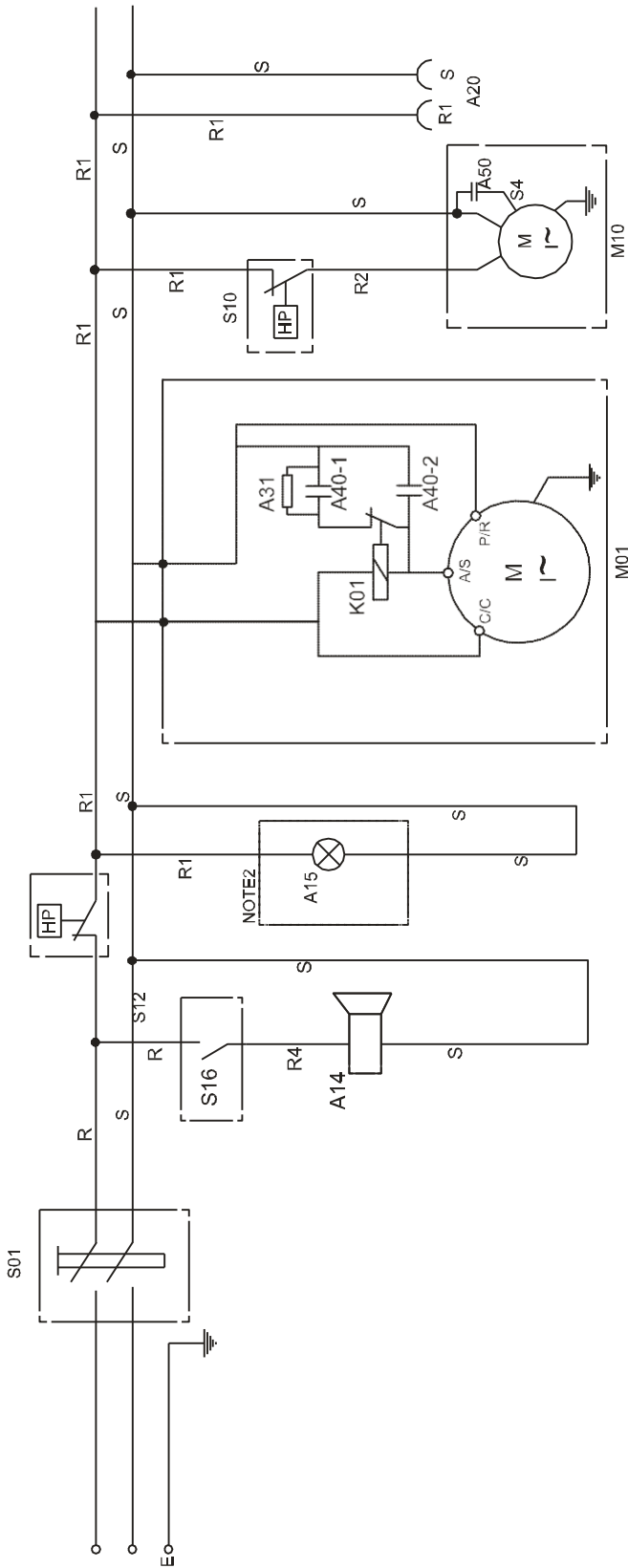

- A14: Filter change buzzer
- A15: Running lamp (green)
- A20: Drain supply
- A31: Bleeder resistor
- A40-1: Start capacitor
- A40-2: Run capacitor
- A50: Fan motor capacitor
- K01: Compressor start relay
- S01: Main switch
- S10: Fan pressure switch
- S12: High pressure safety switch
- S16: Filter service contact
- M01: Compressor motor
- M10: Fan motor
- HP indicates high pressure

Dryair DN140-US - Dryair DN170-US

Electrical Power Circuit

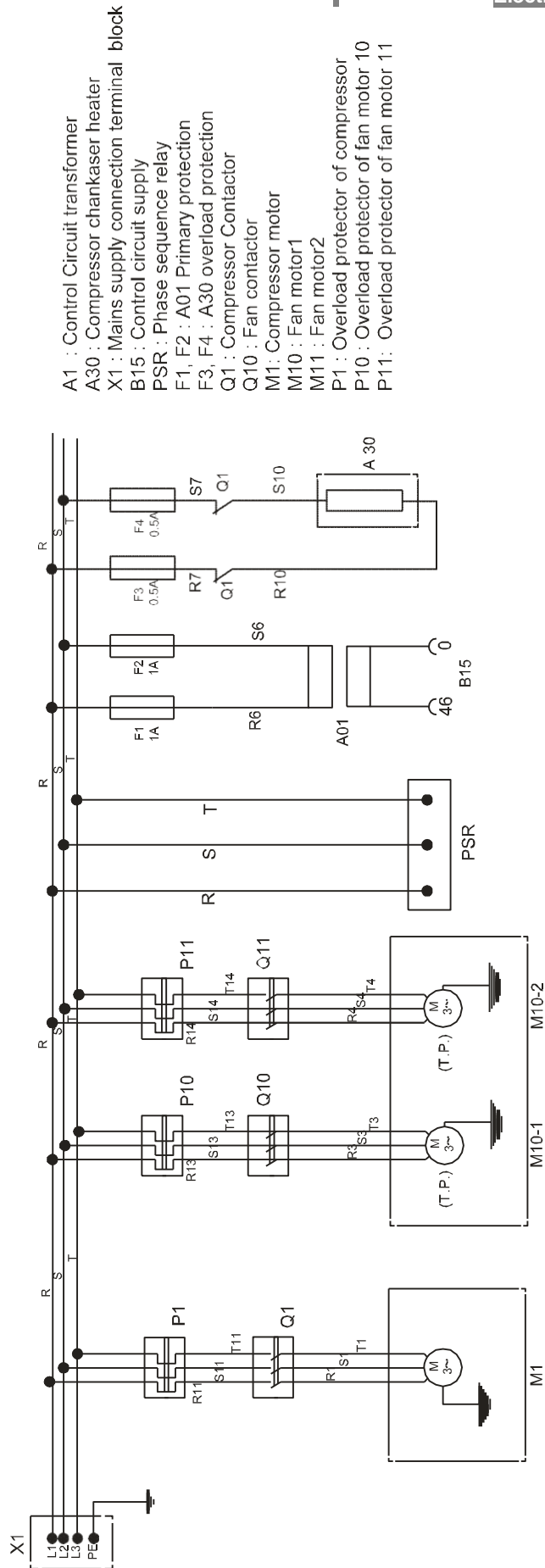

- A1 : Control Circuit transformer
- A30 : Compressor chankaiser heater
- X1 : Mains supply connection terminal block
- B15 : Control circuit supply
- PSR : Phase sequence relay
- F1, F2 : A01 Primary protection
- F3, F4 : A30 overload protection
- Q1 : Compressor Contactor
- Q10 : Fan contactor
- Q11 : Fan motor2
- M1 : Compressor motor
- M10 : Fan motor1
- M11 : Fan motor2
- P1 : Overload protector of compressor
- P10 : Overload protector of fan motor 10
- P11 : Overload protector of fan motor 11

Emax Air Dryer

REFRIGERATED TYPE COMPRESSED AIR DRYERS

General Arrangements

Main Settings

Drawings

6. GENERAL ARRANGEMENTS

Model						
Dryair DN10-US	1 * GKO50X + 1 * GKO50Y	MKO50 KIT	16.26	14.29	21.93	70.40
Dryair DN20-US	1 * GKO50X + 1 * GKO50Y	MKO50 KIT	16.26	14.29	21.93	70.40
Dryair DN30-US	1 * GKO50X + 1 * GKO50Y	MKO50 KIT	16.26	14.29	21.93	70.40
Dryair DN40-US	1 * GKO150X + 1 * GKO150Y	MKO150 KIT	18.62	17.83	32.76	112.20
Dryair DN50-US	1 * GKO150X + 1 * GKO150Y	MKO150 KIT	18.62	17.83	32.76	116.60
Dryair DN60-US	1 * GKO150X + 1 * GKO150Y	MKO150 KIT	18.62	17.83	32.76	121
Dryair DN70-US	1 * GKO500X + 1 * GKO500Y	MKO500 KIT	21.77	19.80	34.41	171.60
Dryair DN80-US	1 * GKO500X + 1 * GKO500Y	MKO500 KIT	21.77	19.80	34.41	182.60
Dryair DN90-US	1 * GKO500X + 1 * GKO500Y	MKO500 KIT	21.77	19.80	34.41	189.20
Dryair DN100-US	1 * GKO851X + 1 * GKO851Y	MKO851 KIT	26.69	25.51	45.55	352
Dryair DN110-US	1 * GKO1210X + 1 * GKO1210Y	MKO1210 KIT	26.69	25.51	45.55	363
Dryair DN120-US	1 * GKO1210X + 1 * GKO1210Y	MKO1210 KIT	37.32	28.66	53.94	484
Dryair DN130-US	1 * GKO1210X + 1 * GKO1210Y	MKO1210 KIT	37.32	28.66	53.94	506
Dryair DN140-US	1 * GKO1820X + 1 * GKO1820Y	MKO1820 KIT	37.32	31.42	57.48	594
Dryair DN150-US	1 * GKO1820X + 1 * GKO1820Y	MKO1820 KIT	37.32	31.42	57.48	627
Dryair DN160-US	1 * GKO2700X + 1 * GKO2700Y	MKO2700 KIT	45.79	30.63	67.91	862.40
Dryair DN170-US	1 * GKO2700X + 1 * GKO2700Y	MKO2700 KIT	45.79	30.63	67.91	902

7. MAIN SETTINGS

Superheat of thermostatic expansion valve	Evaporating pressure	Fan pressure switch	Security (*) high pressure switch	Security (**) low pressure switch	Drain timer (***)	Low pres. High Temp. switch (****)	Water flow valve (if water condenser)
41°F - 50°F	29.7 psi	130 - 174 psi	362.5 psi	23.2 psi	1 min. - 5- sec. 5 min. - 4- sec.	113°F	159.5 psi

(*) Available up to Dryair DN40-US and above

(**) Available up to Dryair DN140-US and above

(***) 1 min. - 5 sec. (up to DN100-US and above)

5 min. - 4 sec. (up to DN90-US and above)

(****) Available up to Dryair DN140-US and above

8. ED and ID DRAWINGS

Dryair DN10-US - Dryair DN30-US

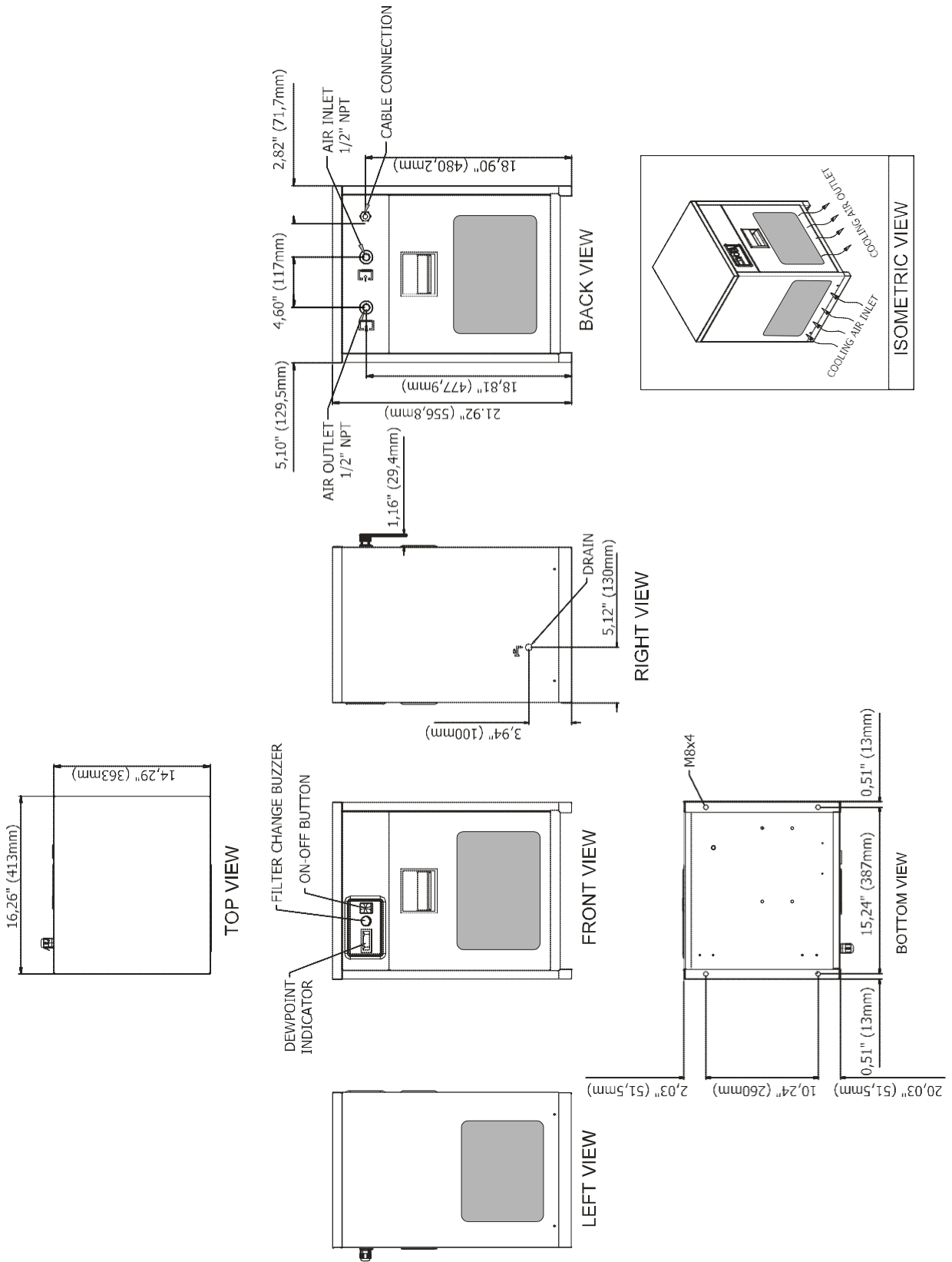

Dryair DN40-US - Dryair DN60-US

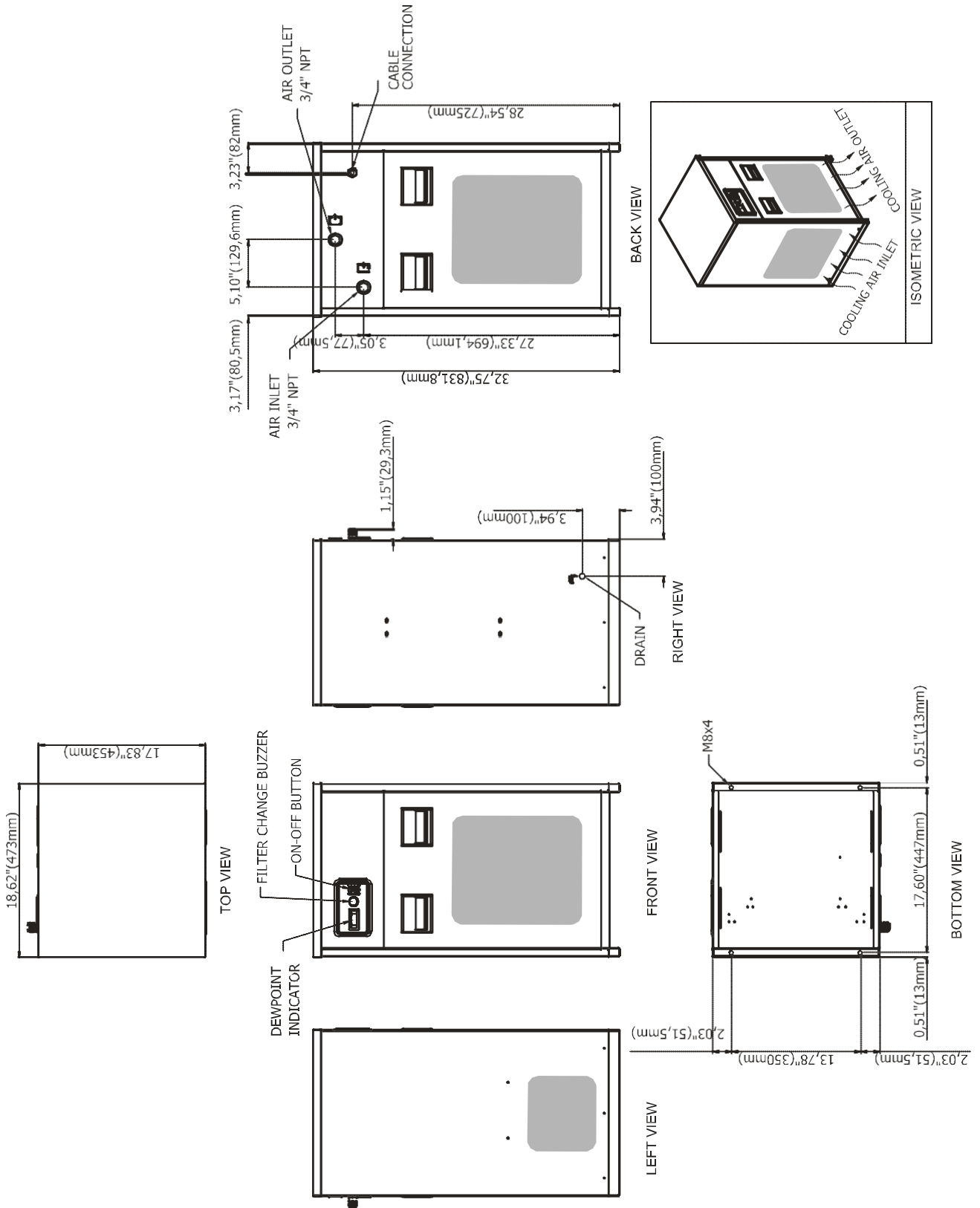

Dryair DN70-US - Dryair DN90-US

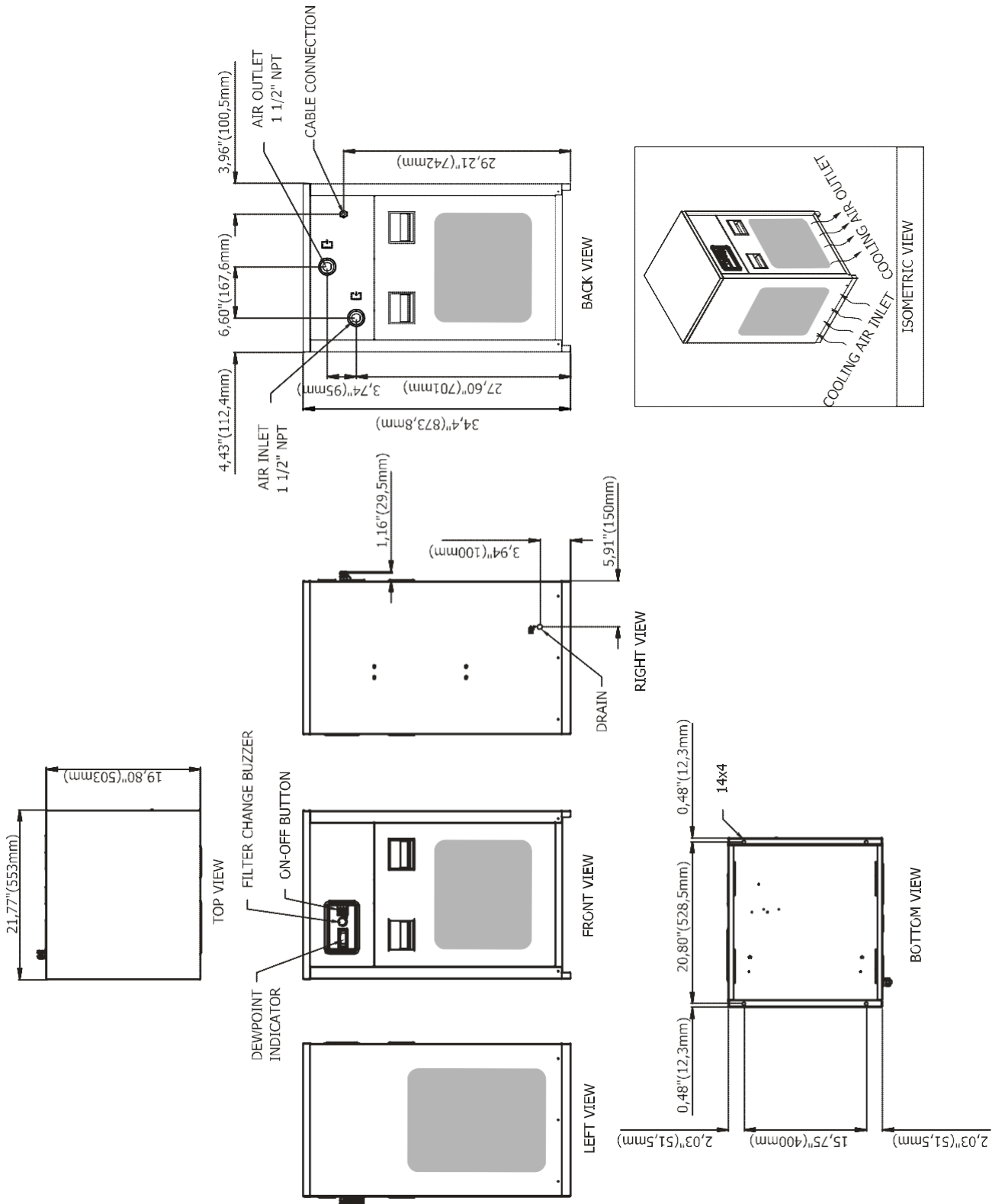

Dryair DN100-US - Dryair DN110-US

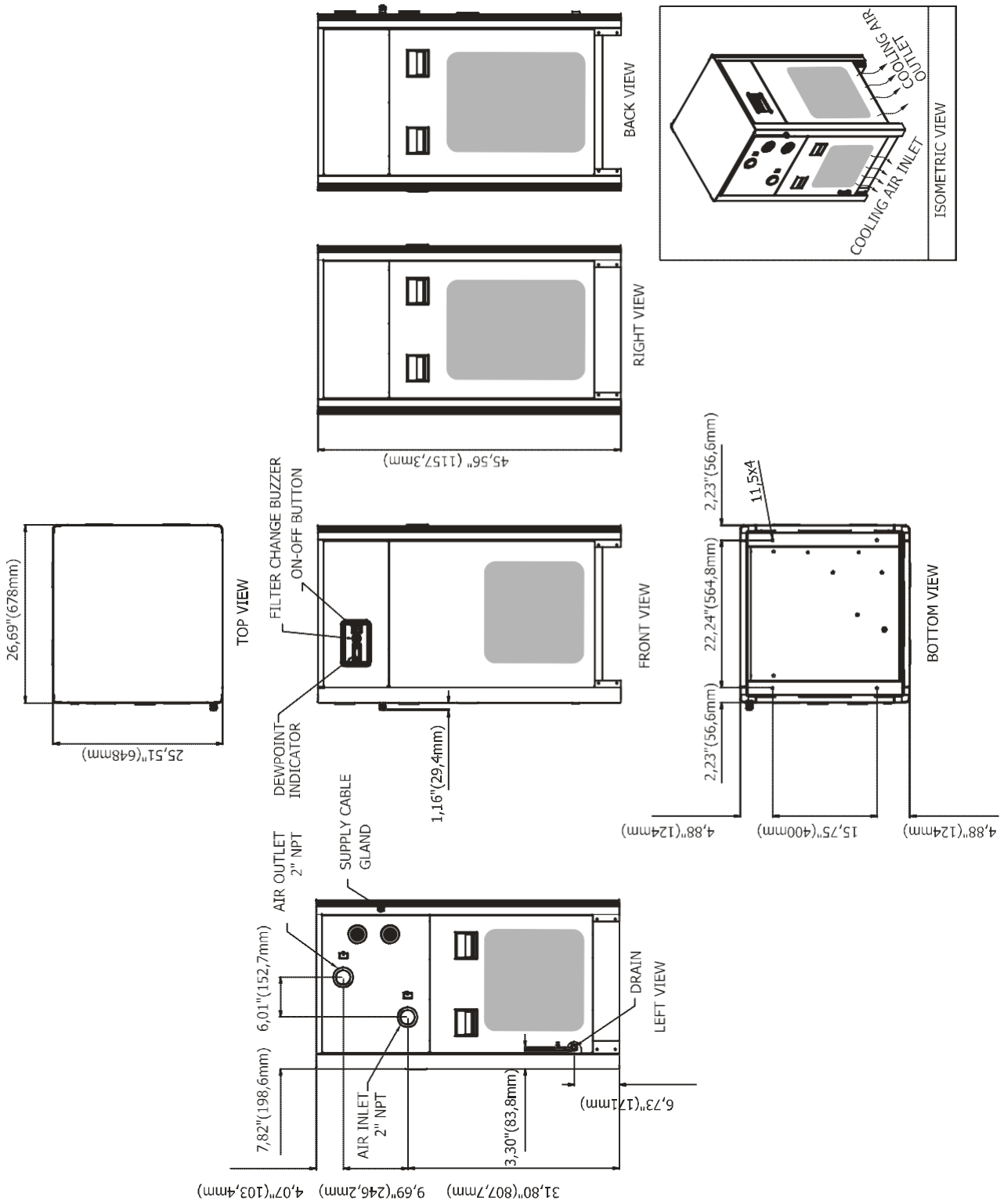

Dryair DN140-US - Dryair DN150-US

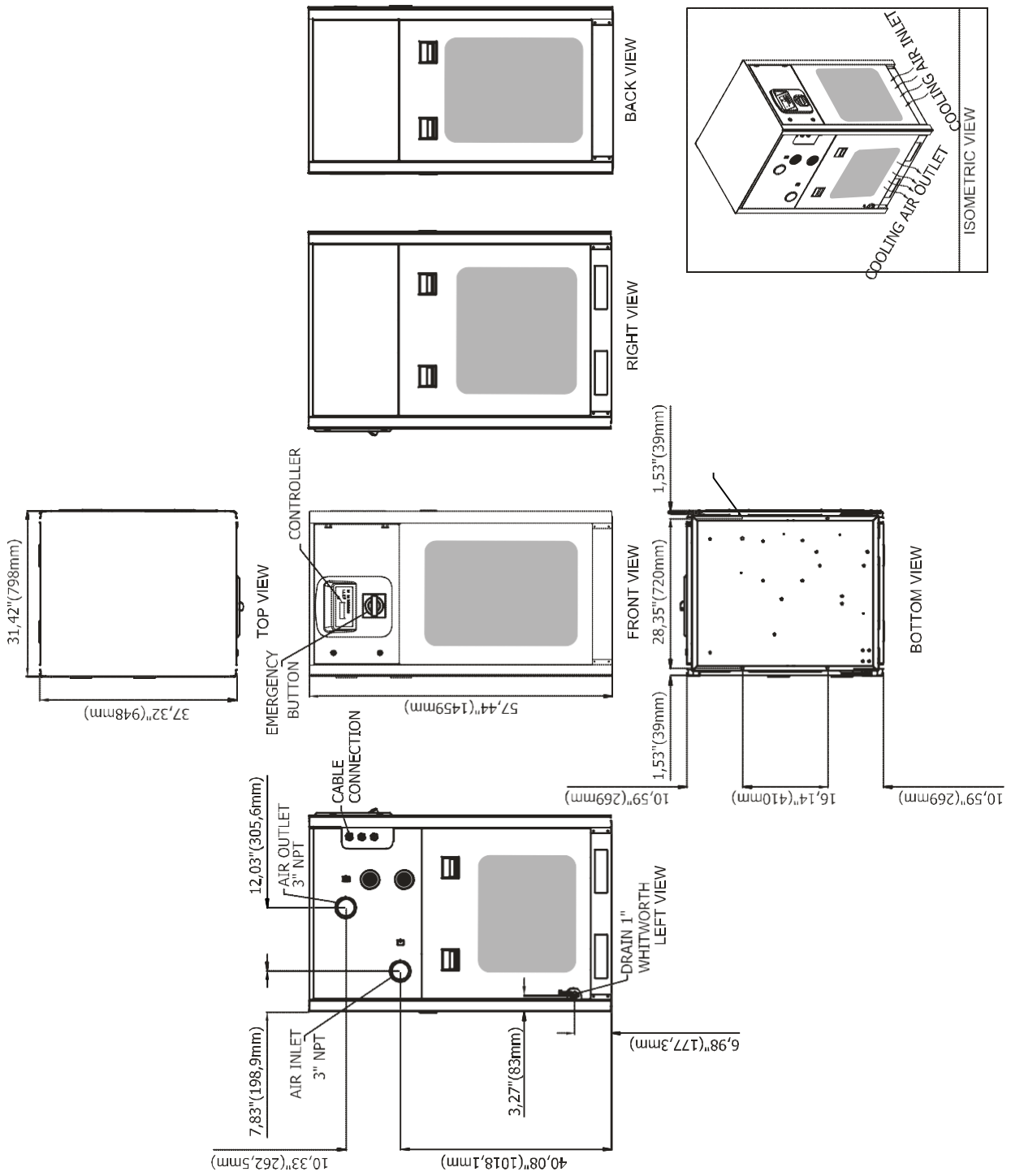

Dryair DN30-US

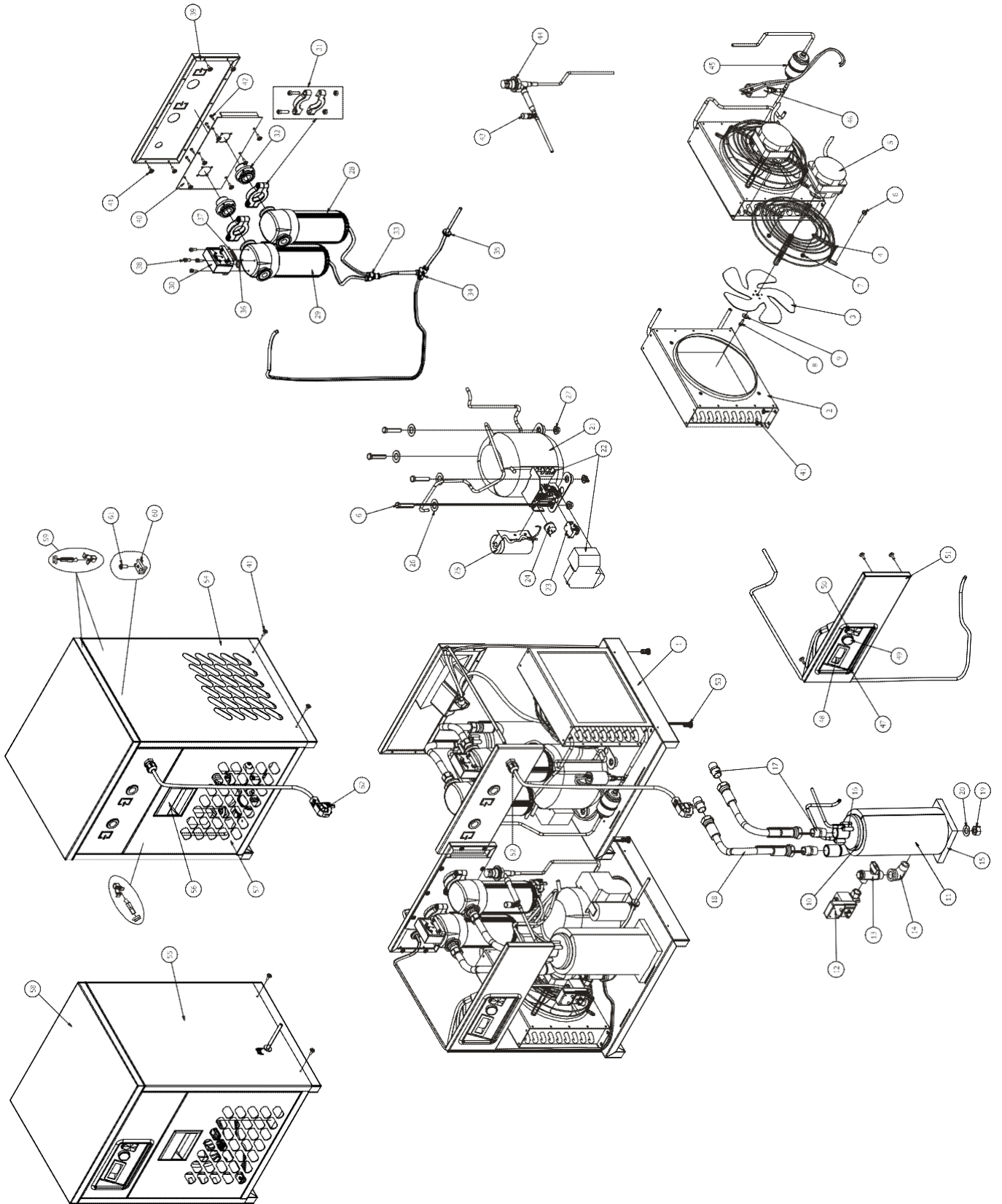

Dryair DN50-US

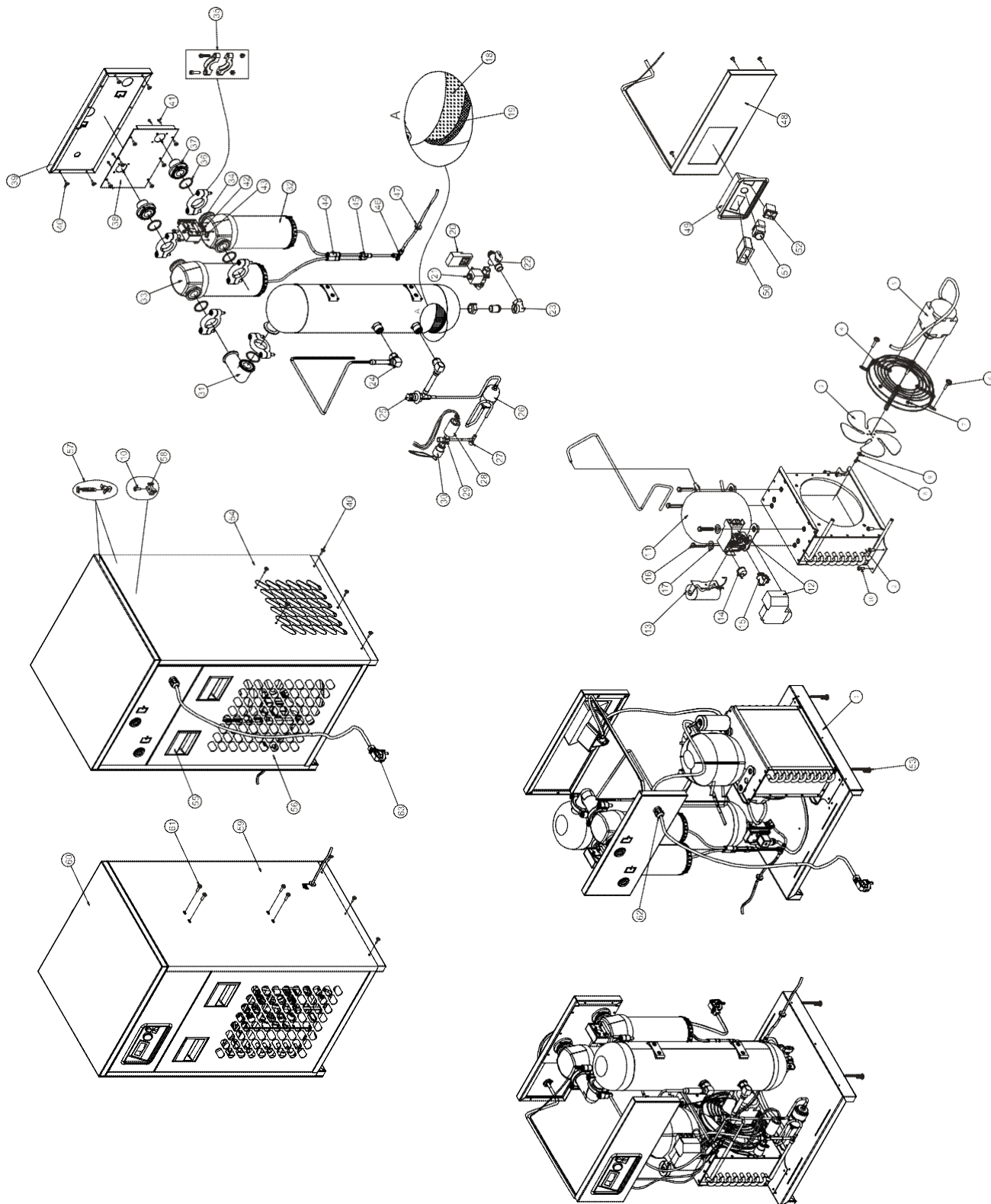

Dryair DN70-US

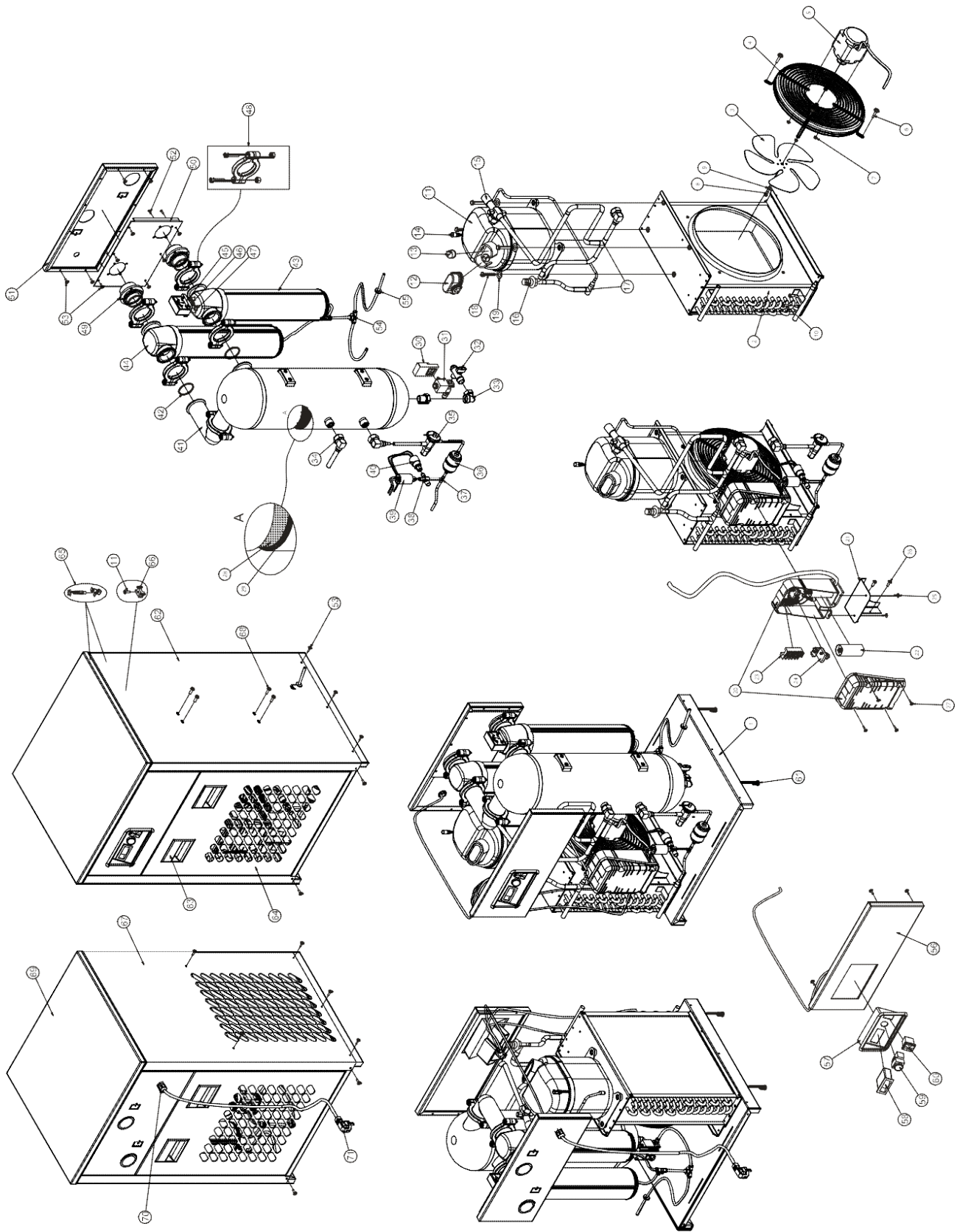

Dryair DN80-US

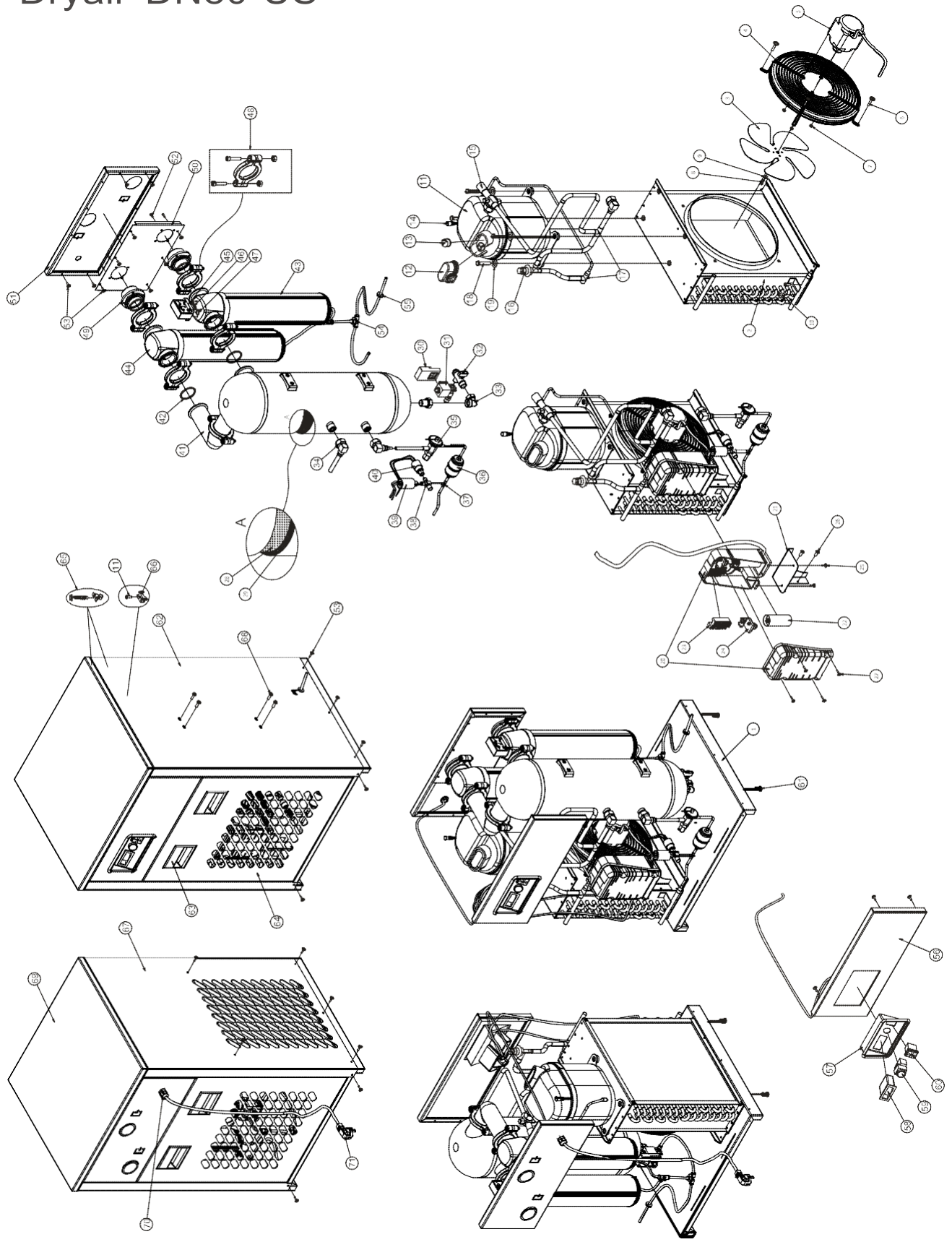

Dryair DN110-US

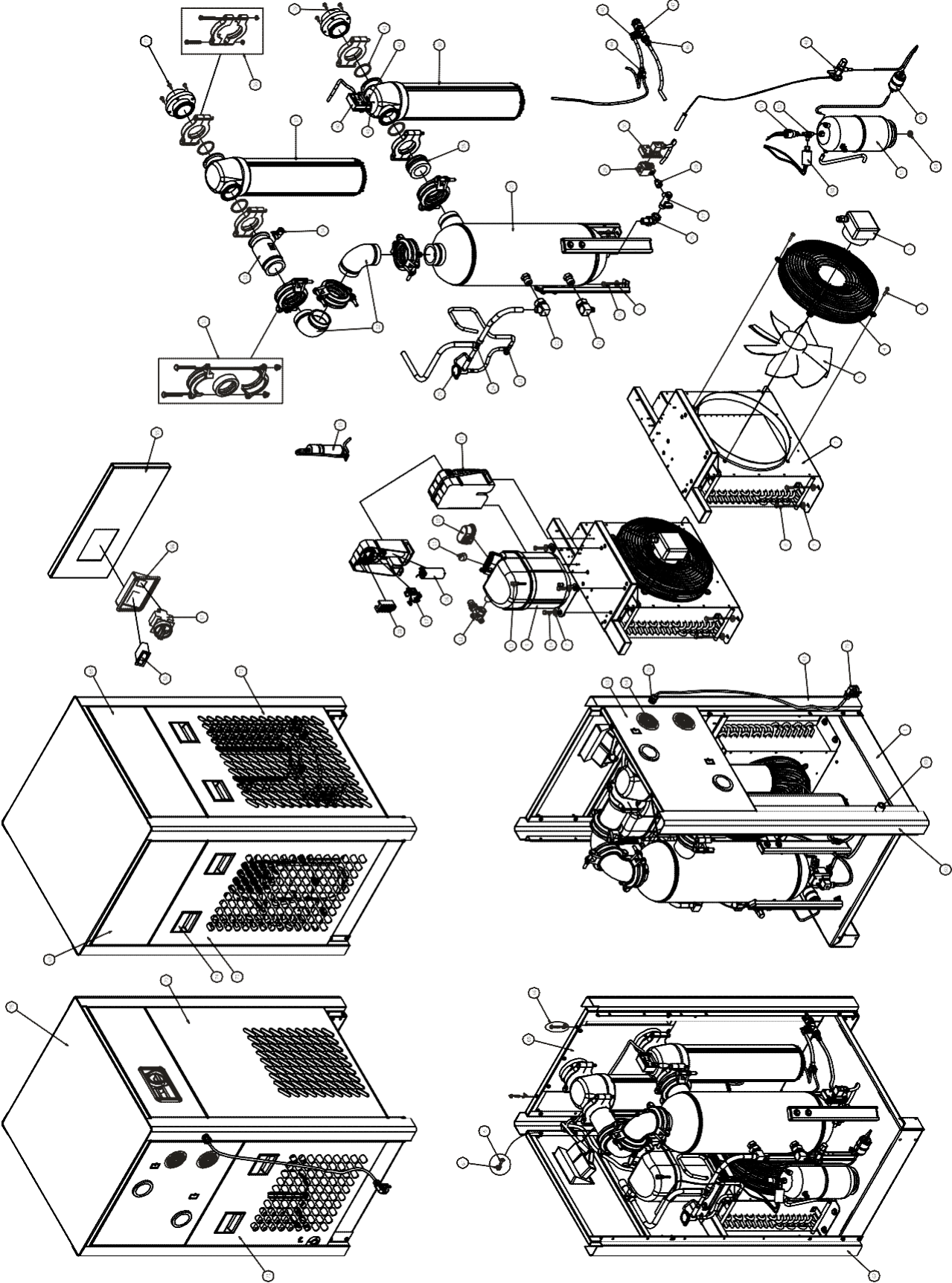

Dryair DN140-US

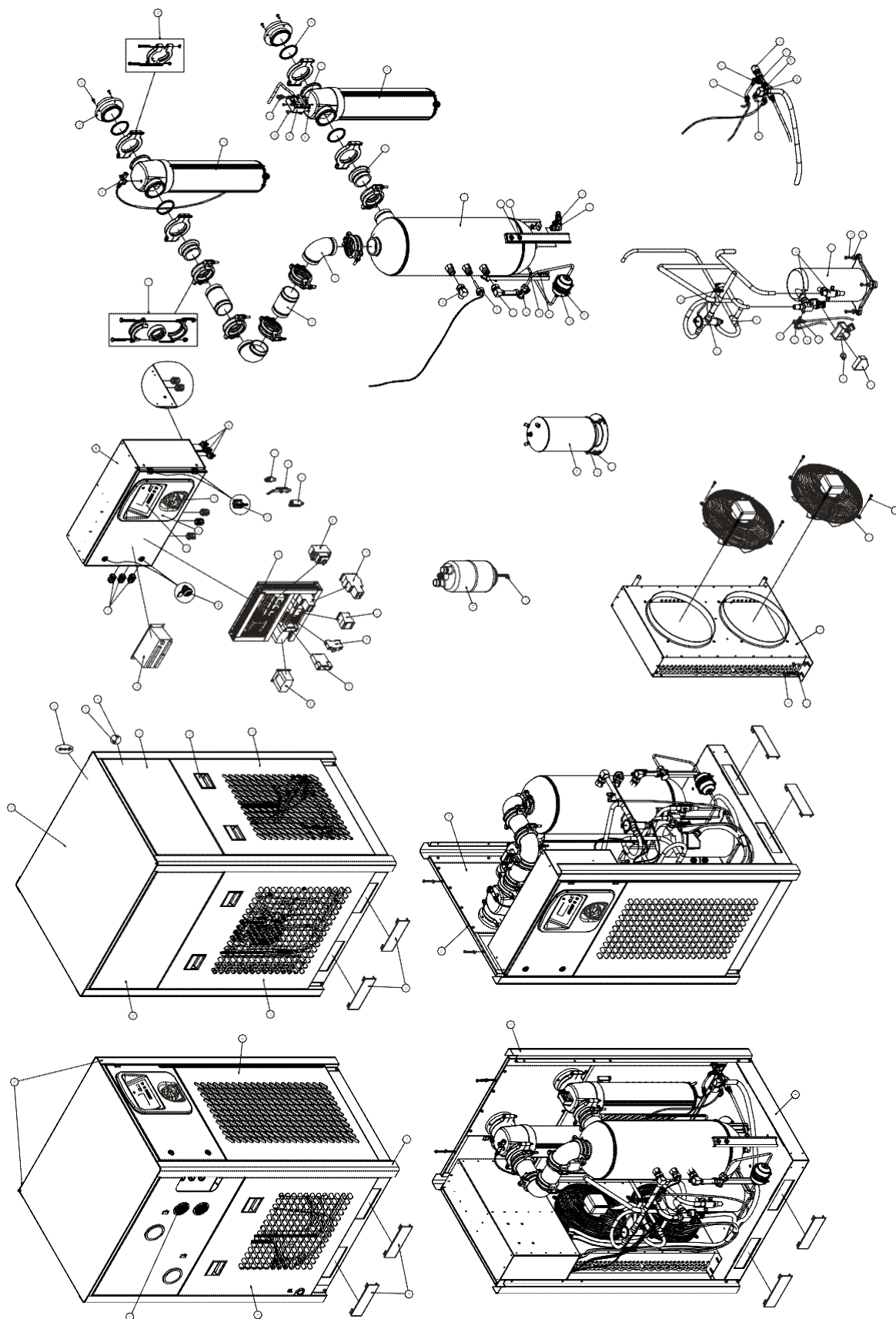

Dryair DN160-US

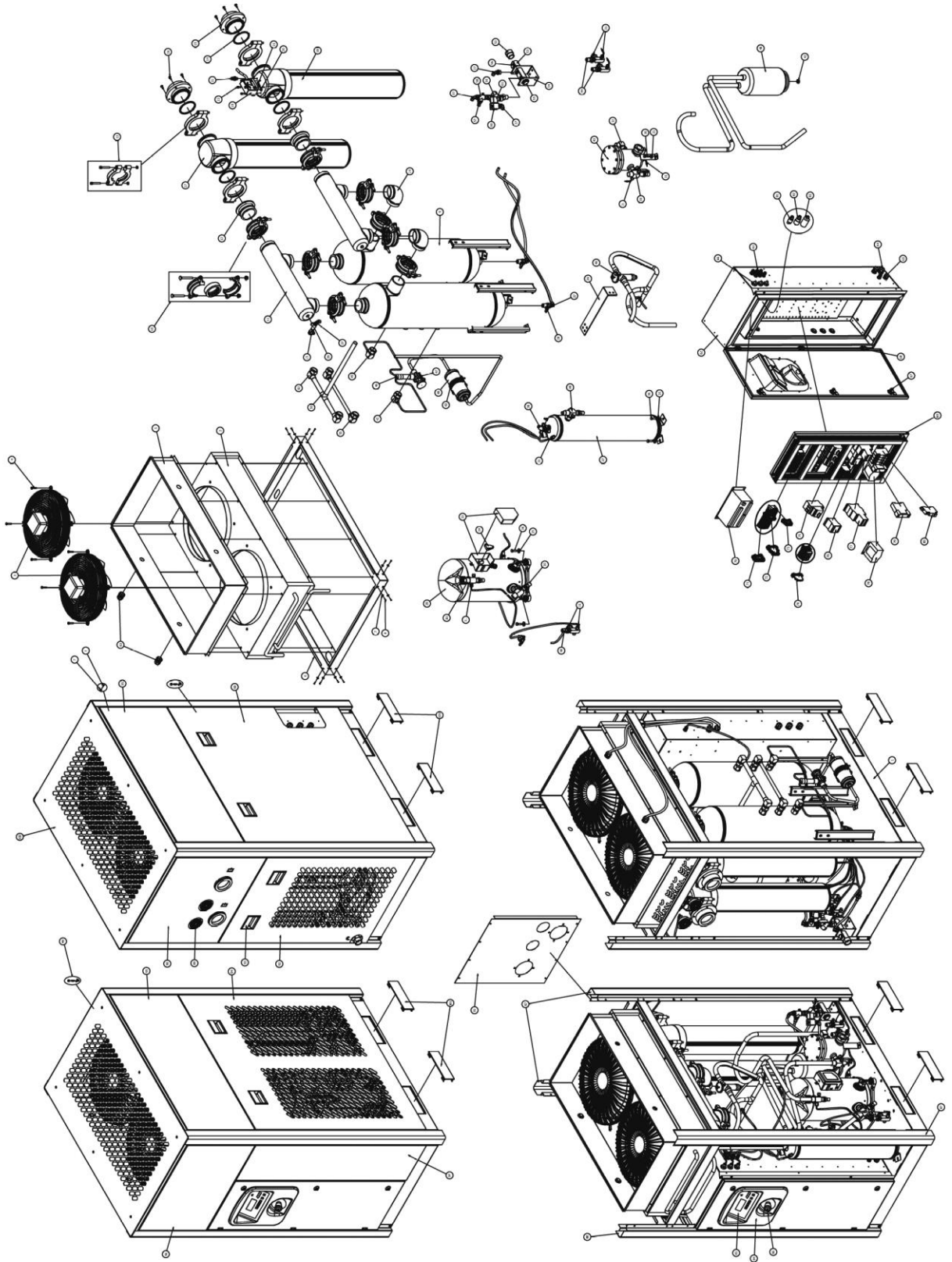

Dryair DN170-US

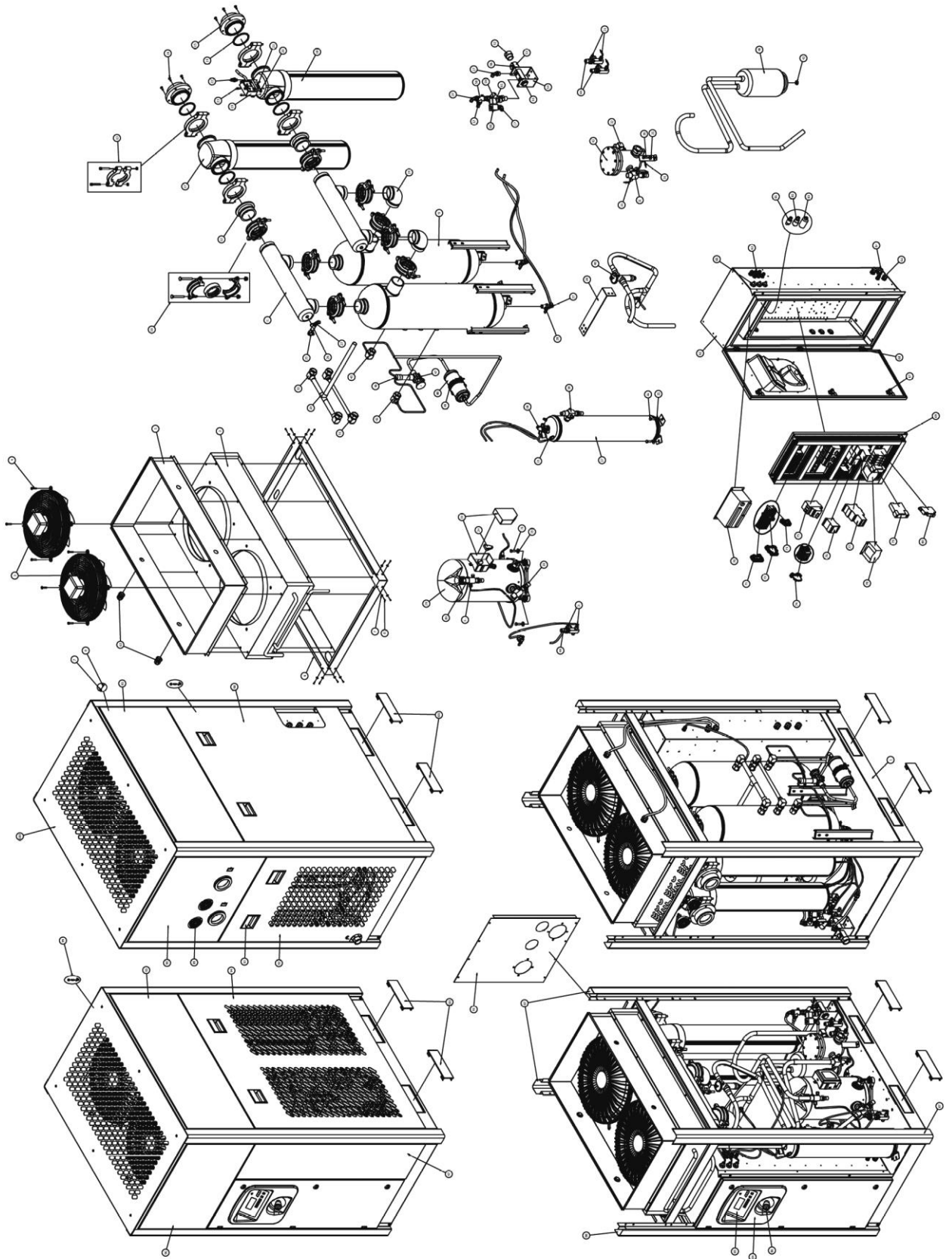

9. COMPONENTS LOCATION

Electrical components:

Accessories :

A01:	Control circuit transformer
A02:	Power circuit transformer
A10:	ON warning light
A11:	OFF warning light
A20:	Drain solenoid valve
A30:	Crankcase heater
A31:	Electrical resistor
A40:	Electrical capacity
A50-3:	Energy Saving Device 3 (ESD3)

S01 :

S02 :

S03 :

S10:

S11 :

S12 :

S13: K01: Compressor motor relay

S20: K10: Fan motor relay

S21: K20: Drain timer or Bekomat (optional)

K30: Temperature Controller

Switches :

Main switch
Start push button
Stop push button
Fan pressure control
High-low pressure security control
High pressure security control
Low pressure security control
Refrigerant temperature control
Air temperature control

Motors:

M01:	Refrigerant compressor motor
M10:	Fan motor

Thermal protections :

P01:	Refrigerant compressor thermal overload
P10:	Fan motor thermal overload

Fuses protections :

See complete identification into electrical sketch
included in dryer

F- -:	Transformer protection
F- -:	Fan protection
F- -:	Compressor relay protection
F- -:	Transformer protection
F- -:	Drain protection
F- -:	Fan relay protection

Refrigerant components:

G01:	Liquid receiver
G02:	Refrigerant drier
G03:	Expansion valve
G04:	Liquid separator
G05:	Hot gas bypass valve
G06:	Refrigerant solenoid valve
G10:	Water cooled condenser
G11:	Water control valve
G20:	Refrigerant evaporating pressure gauge
G21:	Refrigerant evaporating temperature gauge

Compressed air components:

H01:	Air inlet prefilter
H11:	Drain filter
H12:	Pneumatic drain valve

Terminal boxes:

B01:	Main terminal box
B11:	Refrigerant unit terminal box
B12:	Free of potential terminal box

10. TROUBLESHOOTING

Problem	Possible Cause	Repair	Comments	
Dryer is switched on, indicator light is lit but the refrigerant compressor does not turn on.	The connection has inverted phases	Invert two phases	3-phase dryers are equipped with a phase controller to avoid the fans from turning in the opposite direction.	
	Refrigeration unit is not functioning	Check refrigeration compressor	Several factors can cause compressor failure. A qualified refrigeration technician needs to check all the electrical and refrigerant circuit and controls.	
	The refrigerant high pressure protection has tripped	The refrigerant safety high pressure switch has tripped.	In case of water cooled condensers, check the water control valve	The dryer is protected against excessively high refrigerant pressure. If the condenser efficiency has reduced, the switch will trip. Manually reset the switch.
		Excessive ambient temperature		
Dryer is switched on, but the refrigerant compressor does not turn on.	Excessive temperature on crankcase of compressor.	Allow time to compressor to cool down. Reason may be a possible incorrect adjustment of hot gas bypass valve or shortage of refrigerant	Compressor is protected against overly high temperatures of the crankcase by a thermal switch.	
	Excessive compressed air inlet temperature.	Be sure that dryer is working in temperatures lower than design conditions.	The dryer is designed for working in calculated conditions (see description in this manual). If conditions are exceeded, the dryer will be overflowed, dew point will go up and protecting devices can switch off.	
	Clogged condenser fins or clogged water condenser. Possible high crankcase temperature Possible loss of phase Possible low voltage causing overload trip Possible failed compressor	Clear fins or water condenser of all obstructions.	The clogged fins in the condenser will restrict the air passage and reduce the refrigeration capacity, causing high temperature in the evaporator. Same will occur if water condenser is clogged with mud or dirt. Air condenser and water condenser should be periodically checked and cleaned. Protect water circuit by an adapted filter.	
	Too much compressed air flow.	Check actual flow through the dryer.	This dryer is designed for a maximum air flow at design conditions. If too much air is pumped into the dryer, water removal capacity may not be sufficient, resulting in liquid carryover down stream. Check the rated output the air compressor.	
	Faulty electrical wiring	Inspect the circuit	The compressor-on light should be wired into the refrigerant compressor circuit. See wiring diagrams in this manual.	
	One electrical protection has tripped.	Reset the protection or replace the blown fuse.	The dryer is protected against high amp draw by fuse and/or overload relay that can trip in case of need. Reset or replace fuse once, but do not persist if it trips again, request assistance from a qualified refrigeration contractor.	
Dryer is switched on but fan is not running.	Fan has to run if refrigerant high pressure reaches upper set point.	Check that compressed air flows through the dryer. Check that fan blades are free to move. Check the fan pressure switch.	Fan operates automatically to keep refrigerant pressure below the maximum value. The fan can stop if pressure is under the recommended setting.	
When compressor starts, it vibrates a lot and makes mechanical noise.	Compressor is slugging liquid refrigerant at start up.	Be sure the pre-heating period of at least 2 hours is respected	Refrigerant may move between receivers when refrigerant compressor is stopped and not heated, especially if stopped for a long time. This migration may cause liquid shock (slugging) in valves specially on large dryers containing more refrigerant	

Problem	Possible Cause	Repair	Comments
Water in system	Compressed Air Inlet and outlet connections are reversed.	Check inlet and outlet connections.	This dryer is designed for air flow in one direction only. Inlet and outlet directions are identified on the dryer.
	Drain system is clogged or inoperative.	Restore a free flow of water condensate. Check water evacuation.	Drain system is timed solenoid valve, pneumatically assisted which has to be adjusted in accordance with values listed in this manual. The Solenoid valve includes a strainer that has to be periodically checked and cleaned. Membranes of pneumatically assisted drain have to be checked or replaced every 6 months.
	Bypass system is open	Check the valves	Important: Bypass piping should be installed around the dryer so the dryer can be isolated for service without shutting down the air supply. During dryer operation, valves must be set so all air goes into the system. Check tightness of the bypass system.
	Free moisture remains in pipe lines.	Blow out the system	Before the dryer is first started all free moisture should be blown out of the system.
	Excessive air flow	Check actual flow through the dryer.	This dryer is designed for a maximum air flow. If too much air is pumped into the dryer, water removal capacity may not be sufficient, resulting in liquid Carry over downstream. Check the rated flow of the air compressor.
	Excessive free moisture	Check the separator and drain system and compressor after cooler ahead of the dryer.	In some system there may be an accumulation of free moisture in the line ahead of the dryer. If this moisture is pumped into the dryer intermittently, the water removal capacity may not be sufficient. A water separator should be installed in the line before the dryer.
	Excessive compressed air inlet temperature.	Be sure that dryer is working lower than design conditions	The dryer is designed to work for calculated design conditions. Should the conditions be exceeded, the dryer will be overflowed, dew point will go up and protecting devices can switch off.
	Clogged condenser fins	Clear fins of all obstructions	The clogged fins in the condenser will restrict air passage and reduce refrigerant capacity causing water downstream. Fins should be periodically checked and cleaned.
	Shortage of refrigerant	Fix the leak and add a charge of refrigerant.	Loss of refrigerant will cause improper functioning. A qualified, refrigeration specialist should perform the necessary repairs, or factory should be contacted if the unit is in warranty.
	Refrigeration system is not functioning	Check to be certain refrigerant compressor is running	To check if the compressor is running, check compressor-on light. It is possible for the fan to be operating but not the compressor. Compressor not running can be caused by several taeters. A qualified refrigeration technician should check all refrigerant and electrical controls
	Excessive pressure dew point	Readjust refrigerant evaporating pressure	The refrigerant pressure adjustment should be done by a qualified refrigeration engineer. This is a very sensitive device and incorrect settings may create other failures.
High pressure drop	Excessive compressed air flow or too low air inlet pressure.	Check actual pressure and flow through the dryer.	This dryer is designed for a maximum air flow. If too much air is pumped into the dryer, water removal capacity may not be sufficient, resulting in liquid carry-over downstream. Check the rated flow of the air compressor.
	Freeze up	Check that compressor room ambient,	Frosting of the lines is an indication that controls are set too low. The following should be done by an experienced refrigeration technician.
Fan switch could have failed in closed position keeping fan on.		Controls may be adjusted in the fields by means of the hot gas bypass valve. This is to be done by a qualified refrigerant technician.	
The unit will not run or cycles off and on.	Clogged heat exchanger	Clean heat exchanger with areverse air flow.	Dryer are supposed to be used with compressed air free of any aggressive contaminants. Some contamination may require extra maintenance of the heat exchanger.
	Line disconnect switch is open.	Close the start or disconnect switch.	If the dryer is not operating, check the disconnect switch or circuit breaker to be certain it is on.
	Fuse or breaker is open	Replace fuse or reset breaker.	The fuse to the power line should be checked and replaced if needed. Never replace a burnt fuse with an oversized fuse.
	Faulty refrigerant compressor or controls.	Determine the cause and make correction	Failure of compressor to run may be caused by several factors. A qualified refrigeration specialist should check all electrical and refrigeration controls, or factory should be contacted if unit is in warranty.
	Excessive compressed air inlet temperature.	Design conditions and correction factors are described in this manual. Be sure that dryer is working in ambient temperatures below design conditions.	The dryer is designed for working into calculated design conditions. Should the conditions be exceeded, the dryer will be overflowed, dew point will go up and protecting devices may trip.

Problem	Possible Cause	Repair	Comments
The unit will not run or cycles off and on.	Excessive ambient temperature	Designed conditions and correction factors are described in dryer . Be sure that dryer is working lower than design conditions.	A high ambient temperature may cause the refrigerant system to operate at higher than normal pressures. Results will be a higher than normal evaporator temperature. Important: there should be adequate air circulation around the dryer, and proper ventilation in the equipment room should guarantee a low enough ambient temperature.
	Clogged condenser fins	Clear fins of all obstructions.	The clogged fins in the condenser will restrict the air passage and reduce the refrigeration capacity, causing high temperature in the evaporator. Fins should be periodically checked and cleaned.
	Shortage of refrigerant	Fix the leak and add a charge of refrigerant.	Loss of refrigerant will cause improper functioning. Dryers are equipped with a temperature switch which maintains the amount of refrigerant to maintain proper cooling of the compressor. A shortage of refrigerant may cause suction line to become very hot, causing the temperature switch to trip. A qualified refrigeration specialist should perform the necessary repairs.
Error sign occurs on digital temperature control device	The dew point is too low or too high.	Check refrigerant gas and make sure that the working conditions are within the correct range.	If there is not enough refrigerant gas or if the working temperature and inlet temperatures are very high, the dew point will increase.

Refrigerated Dryer WARRANTY POLICY

When used under the conditions recommended the heat exchanger will be warranted for five (5) years. This warranty is limited to the replacement of the heat exchangers,

Some restrictions as outlined below concerning misuse, abuse or accident. The standard equipment external float drain and automatic drain carry a 90-day warranty.

This warranty will apply to equipment installed, operated and maintained in accordance with the procedures and recommendations as outlined in the owner's manual published by Emax During the life of this warranty, Emax will repair or replace (at Polar air's option) any defective part or assembly free of charge if such defect occurred in normal service and was not due to apparent misuse, abuse or accident.. Customer is responsible for shipping charges.

This Warranty is not transferable.

Any warranty service performed in the field must be authorized by EMAX air Unauthorized service voids the warranty and any resulting charges will not be paid by Emax

Polar air makes no other warranties or guarantees, expressed or implied. Polar air assumes no liability for indirect or consequential damages.