



Application:

RA 2000 Thermostatic Radiator Valves regulate the flow of hot water or low pressure steam through free-standing radiators, baseboards, or convectors in hot water and two-pipe steam

systems. Operators and valves are packaged separately to allow an installer to select a suitable combination for each application.

Operator Features:

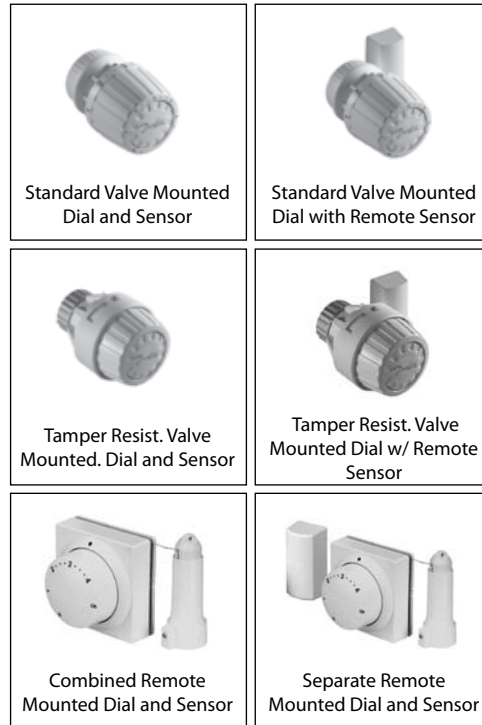

- Valve mounted operators provide fast acting modulating control of the space temperature through a patented vapor charge, ensuring the highest level of comfort control.
- Standard valve mounted operators are equipped with a “snap-action” mechanism that allows for easy installation and removal without the use of tools. Optional anti-theft protection clips are available.
- Tamper resistant versions of the valve mounted operators are available to discourage unauthorized adjustment, vandalism and theft.
- Conforms to ASHRAE / ANSI Standard 102-1983.

Valve Features:



- RA 2000 valves are fitted with a packing gland assembly that is replaceable while the system is in operation. The packing gland is fitted with a grease cup to ensure the o-ring packing is lubricated for life.
- Sturdy EPDM rubber valve disc provides a positive seal against the valve seat at differential pressures of up to 15 PSI in hot water heating systems, while 15psig for low pressure steam systems.
- Plastic cap supplied to protect the valve pushpin can provide manual control of the valve during installation. If manual operation is required, a separate hand knob is available as an accessory.
- Valves remain normally open with no operator mounted.
- Conforms to ASHRAE / ANSI Standard 102-1983.

Technical Specifications:

Hydronic Hot Water Systems

Maximum Temperature: 250 °F
Maximum Static Pressure: 145 psi
Maximum Test Pressure: 232 psi
Max. Diff. Pressure (water): 15 psi
Max. Sensor Temperature: 140 °F
Adjustable Temp. Range: 45-86°F (7-30°C)

Two-Pipe Low-Pressure Steam Systems

Maximum Temperature: 250 °F
Maximum Test Pressure: 232 psig
Maximum Steam Pressure: 15 psig
Max. Sensor Temperature: 140 °F
Adjustable Temp. Range: 45-86°F (7-30°C)

Comfort Control:

Control of the space temperature at a comfortable level is easily accomplished by adjusting the dial clockwise or counter-clockwise. The dial has a numbered scale of 1 to 5 corresponding to temperatures of approximately 57°F to 79°F (14°C to 26°C).

Should the space be unoccupied for an extended period, the dial can be set to the "*" symbol for freeze protection (50°F or 9°C) to save energy.

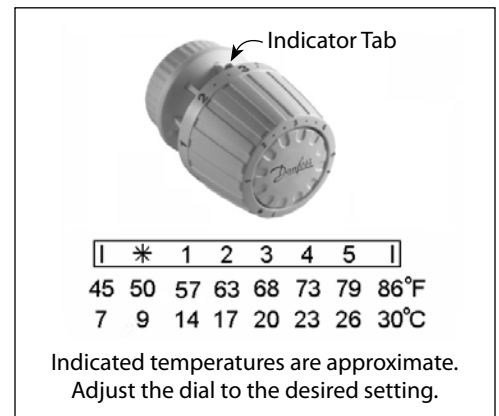

Design and Function:

The RA 2000 thermostatic operator consists of a saturated vapor charged bellows and a setting dial. The dial is set to the position equal to the desired temperature. When the ambient temperature lowers, the pressure from the bellows will reduce, allowing the valve to open. A rise of temperature increases the pressure

in the bellows closing the valve. The balanced pressures between the adjustment spring and the bellows ensure a smooth and modulating operation of the valve. Danfoss RA 2000 are manufactured to the highest quality standards in an ISO 9001 factory.

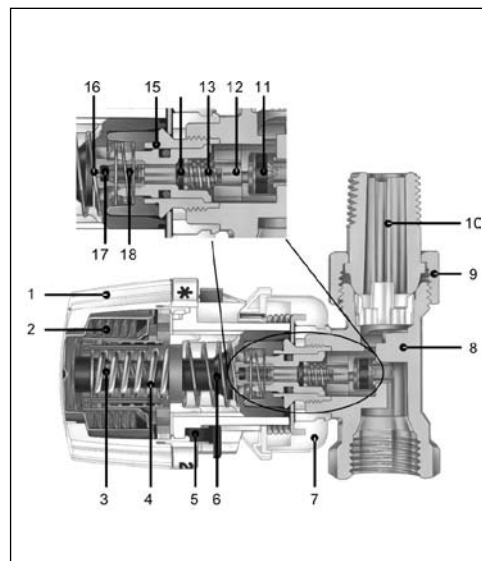

No. Description:

- 1- Operator setting dial (ABS)
- 2- Vapor charged bellows
- 3- Safety spring (steel)
- 4- Adjustment spring (steel)
- 5- Locking/limiting pin (steel)
- 6- Pressure spindle (plastic)
- 7- Snap-on mounting ring (plastic)
- 8- Valve body (nickel plated brass)
- 9- Union nut (nickel plated brass)
- 10- Tailpiece (nickel plated brass)
- 11- Valve disc (EPDM)
- 12- Valve spindle (brass)
- 13- Valve spring (stainless steel)
- 14- Back seat washer (EPDM)
- 15- Valve bonnet (brass)
- 16- Pressure pin (stainless steel)
- 17- Packing o-ring (EPDM)
- 18- Packing gland (DRZ brass)

Applications:

Typical Installation Configuration	=	Operator Type	+	Valve Type
<p>Free-Standing Radiators The freestanding hot water or low-pressure steam radiator is located where air circulation is unobstructed and passes freely over the operator.</p>	=	<p>Valve -mounted dial and sensor, standard or tamper resistant models. Always install these operators in a horizontal position.</p>	+	<p>Straight, Side-Mount Angle or Double Solder Union</p>
<p>Free-Standing Radiators Freestanding hot water or low-pressure steam radiator. Air circulation does not pass freely over the operator due to furniture, drapes, coverings, etc.</p>	=	<p>Valve -mounted dial with remote sensor, standard or tamper-resistant models. The sensor can be mounted on a wall up to 6 feet away in a location free of drafts.</p>	+	<p>Straight, Angle, Side-Mount Angle or Double Solder Union</p>
<p>Baseboards/Convectors The hot water or low-pressure steam fin-tube baseboard or convector is located where air circulation is unobstructed and passes freely over the operator.</p>	=	<p>Valve -mounted dial and sensor, standard or tamper resistant Models. Always install these operators in a horizontal position.</p>	+	<p>Straight, Side-Mount Angle or Double Solder Union</p>
<p>Baseboards/Convectors Hot water or low-pressure steam fin-tube baseboard or convector. Air circulation does not pass freely over the operator due to furniture, drapes, coverings, etc.</p>	=	<p>Combined remote mounted dial and sensor. The dial operators are wall mounted and are available with 6', 16' or 26' long capillary tubes.</p>	+	<p>Straight, Angle, Side-Mount Angle or Double Solder</p>
<p>Baseboards/Convectors The hot water or low-pressure steam fin-tube baseboard or convector arrangement requires the dial and sensor to be mounted separately, away from the valve.</p>	=	<p>Separate remote mounted dial and sensor. The remote dial mounts on the wall or enclosure (max. 6' away). The sensor is mounted beneath the radiation or on a draft free wall 6' away from the dial.</p>	+	<p>Straight, Angle, Side-Mount Angle or Double Solder Union</p>

Important!

Valve mounted dial and sensor operators should be installed horizontally. If mounted vertically, the operators will sense



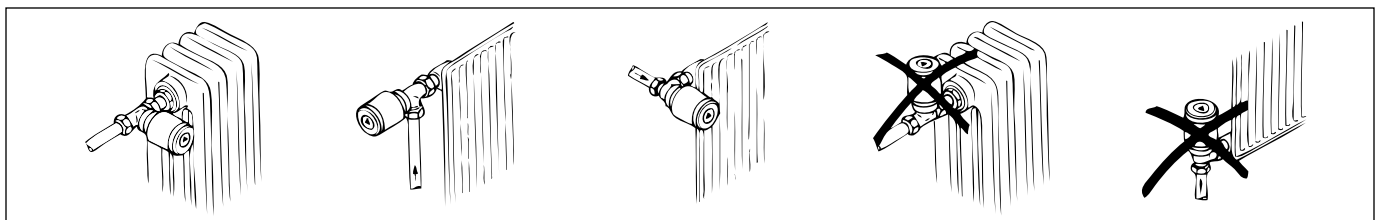



heat radiating upwards from the valve resulting in the premature closing of the valve.









Ordering Information:

RA 2000 Operators

Operator	Code No.	Description	Sensor	Capillary
	013G8250	Valve mounted dial and sensor	Built-in	-
	013G8252	Valve mounted dial with remote sensor	Remote	6'
	013G8240	Valve mounted dial and sensor, Tamper-resistant	Built-in	-
	013G2922	Valve mounted dial with remote sensor, Tamper-resistant	Remote	6'
	013G8562	Combined remote mounted dial and sensor*	Built-in	6'
	013G8565	Combined remote mounted dial and sensor*	Built-in	16'
	013G8568	Combined remote mounted dial and sensor*	Built-in	26'
	013G8564	Separate remote mounted dial and sensor*	Remote	6' + 6'
	013G5002	Manual adjustment handle	-	-

* Includes sockets for use on RAV, KOVM and VMT valve bodies.

RA 2000 Valves					
Valve	Code No.	Size	Valve Type	Cv*	Connections (inlet x outlet)
	013G8015	1/2"	Straight	1.6	FPT X MPT Union Tailpiece
	013G8020	3/4"		2.7	
	013G8025	1"		2.8	
	013G8032	1-1/4"		2.8	
	013G8014	1/2"	Angle	1.6	FPT X MPT Union Tailpiece
	013G8019	3/4"		2.7	
	013G8024	1"		2.8	
	013G8031	1-1/4"		2.8	
	013G8013	1/2"	Side Mount Angle	1.6	FPT X MPT Union Tailpiece
	013G8018	3/4"		2.1	
	013G8023	1"		2.8	
	013G8030	1-1/4"		2.8	
	013G8042	1/2"	Straight	1.6	Double Solder Union
	013G8044	3/4"		2.7	

* Cv is the water flow rate through the fully open valve at a pressure drop of 1psi. To determine the pressure drop through the valve at other flow rates use the formula: $\Delta P = (Q/Cv)^2$, where Q= water flow in GPM

Dimensions:

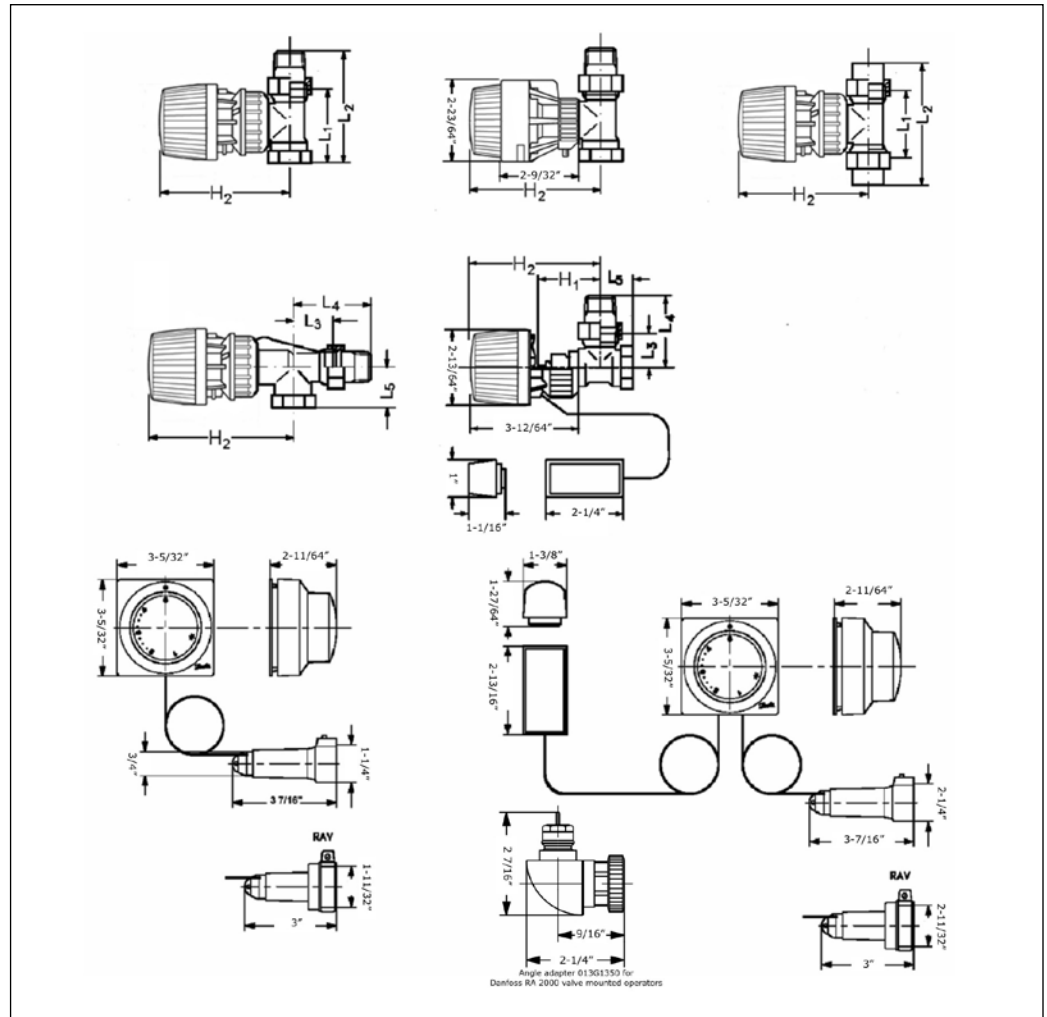

Valve Type	Connection Type	L1	L2	L3	L4	L5	H1	H2
Straight	1/2" NPT	2-5/8"	3-3/4"				1-57/64"	3-3/4"
	3/4" NPT	2-29/32"	4-3/16"				2-1/16"	3-15/16"
	1" NPT	3-17/32"	4-31/32"				2-1/16"	3-15/16"
	1-1/4" NPT	4-1/4"	5-29/32"				2-9/64"	4-1/64"
Angle	1/2" NPT			1-3/16"	2-9/32"	1-1/64"	1-57/64"	3-3/4"
	3/4" NPT			1-11/32"	2-5/8"	1-9/64"	2-1/16"	3-15/16"
	1" NPT			1-9/16"	3"	1-11/32"	2-1/16"	3-15/16"
	1-1/4" NPT			1-3/4"	3-3/8"	1-9/16"	2-1/16"	3-15/16"
Side Mount	1/2" NPT			1-1/8"	2-1/4"	1-1/64"	2-3/8"	4-1/4"
	3/4" NPT			1-11/32"	2-5/8"	1-9/64"	2-7/16"	4-5/16"
	1" NPT			1-9/16"	3"	1-11/32"	2-3/8"	4-1/4"
	1-1/4" NPT			1-3/4"	3-3/8"	1-9/16"	2-3/8"	4-1/4"
Double Solder	1/2"	2-5/8"	3-15/16"				1-57/64"	3-3/4"
	3/4"	2-15/16"	4-5/8"				2-1/16"	3-15/16"



Capacity:

Hydronic Hot Water Applications

Example:

Flow Required:
0.65 US GPM
Pipe Size: 1/2"

Solution:

Draw a line from 0.65 USgpm until it intersects with the dashed line for the 1/2" valve. Draw a vertical line down to find the additional system pressure drop due to the valve will be 0.6 psi.

Note: For best control, select valve based on 4°F P-deviation and maximum 5 psi pressure drop. P-deviation is the difference between the thermostat setting and the actual space temperature. For best comfort control and long life, valves should be selected to provide design flow at a 4°F P-deviation.

The shaded area represents differential pressure above those recommended for quiet operation. The maximum differential pressure ratings indicate the maximum pressure at which valves regulate satisfactorily. In order to prevent noise, pumps that provide only the required pressure should be recommended. Experience shows that in most systems a differential pressure of 0.5 - 2.5 psi across the valve is sufficient to provide the required flow.

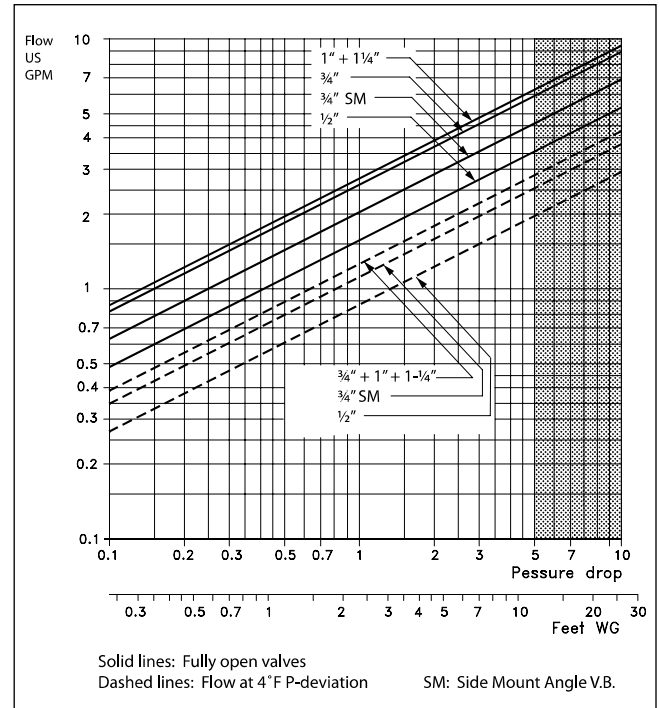

Low Pressure Steam Applications:

Step-by-step selection technique

1. Before selecting valves, consider P-deviation.
2. Check that system pressure is below 15psig.
3. Determine load requirements for each valve.

Solution:

From the table below a 3/4" valve will provide 28MBH at a 4°F P-deviation at a pressure drop of 3psi. If the system pressure is 3psi or greater a 3/4" valve can be used.

Example:

Design load: 28MBH
Pipe Size: 3/4"
P-deviation ≤ 4°F

Pressure Drop		1 psig		2 psig		3 psig		4 psig		5 psig	
P-Deviation °F		4	Fully open	4	Fully open	4	Fully open	4	Fully open	4	Fully open
Valve Size	Rating Code										
1/2"	MBH	10	16	14	22	16	28	20	32	35	62
3/4"	MBH	15	30	20	40	28	50	32	58	60	108
1" & 1-1/4"	MBH	18	40	25	52	30	60	36	72	66	140

Conversion Factors:

Sq. ft. EDR to Btu/hr = Sq. ft. EDR x 240 (steam)
Btu/hr to Sq. ft. EDR = Btu/hr / 240
1 MBH = 1,000 Btu/hr

Rating Abbreviations:

MBH = Thousands of Btu/hr.

EDR = Equivalent Direct Radiation

Important

P-deviation refers to the difference between the thermostat setting and the actual space temperature. For best comfort and long life, valves should be selected which provide the design heating load at approximately a 4°F P-deviation.

Spare Parts and Accessories:

	Code No.	Description
RA 2000 Valve Mount Operators 013G8250 013G8252 013G8240 013G2922	013G1236	Screwdriver tool set
	013G1246	Limitation pins for RA 8250/52 (10 pcs)
	013G1237	Limitation pins for tamper resistant operators RA 8240 / 2922 (30 pcs)
	013G5245	Anti-theft protection clips for RA 8250/52 (20 pcs)
	013G1232	Locking screw plugs for tamper resistant operators RA 8240 / 2922 (10 pcs).
	013G1672	Cover plate for scale window of tamper resistant operators (20 pcs)
	013G1350	Angle Adapter for RA 2000 valves & sensors

RA Socket For RA 2000 Wall Mount Operators			
013G8562 013G8565 013G5068 013G8564 013G8568	Code No.	Description	Position No.
	013G8591	Socket Body for RA 2000	1
	013G5503	Bellows Holder (set of 2 pcs)	2

RA Socket For RA 2000 Wall Mount Operators			
013G8562 013G8565 013G5068 013G8564 013G8568	Code No.	Description	Position No.
	013G8593	Socket Body for RAV, VMT and KOVM	1
	013G5503	Bellows Holder (set of 2 pcs)	2

	Code No.	Description
RA 2000 Valve Bodies	013G0290	Packing Gland
	013G5002	Manual adjustment handle (Water applications only)
	013-7045	Gasket for RA valves
	013G8070	RA to RA 2000 adapter
	013G8072	RAV to RA 2000 adapter
	013G8037	Insert, valve top & gland replacement, 1/2" NPT angle & straight valve
	013G8038	Insert, valve top & gland replacement, 1/2" NPT sidemount angle valve
	013G8039	Insert, valve top & gland replacement, 1/2" solder, & all 3/4", 1", 1-1/4"
	003L0213	Demounting tool for valve tops RA 2000, RA-S, RA-N, FHV-A
	013G1350	Right angle Operator adapter

Changing the Packing Gland:

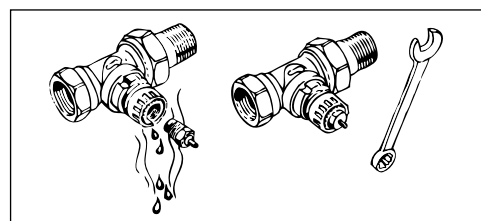

Should the packing gland on the valve body show signs of weeping, it can be replaced in a few minutes with the system in operation.

Order packing gland 013G0290 for RA 2000 and FHV-A valves.

**Warning:**

Brass products such as Danfoss thermostatic radiator valves should not be installed in hydronic or steam heating systems that are being treated with medias that contain, or that during the process of treatment could develop, agents aggressive to brass. In concentrations larger than shown, agents such as Ammonia (0.2mg/l), Mercury (0.01mg/l), Oxygen (0.01mg/l), Carbon Dioxide (0.05mg/l), or Chloride (20mg/l) must be avoided. Further the pH-value of the medium in contact with the brass products should not exceed 9.5.

Neglecting the above restrictions may in some circumstances cause damage to the brass in the valve allowing the heating fluid to escape, possibly scalding any bystanders.

Note: To avoid internal damage and void the warranty, mineral oils must not come in contact with EPDM valve components.

Typical Specifications:

The thermostatic radiator valve assembly shall be a two part assembly consisting of the brass valve body and thermostatic operator. The brass valve body shall have a packing gland assembly capable of replacement while the system is in operation. The valve shall be available in a straight, angle, or side mount

orientation. The thermostatic operator shall be available in either a valve or wall mounted dial operator. The valve mounted dial shall be a vapor charged operator and installed via snap-action mechanism or Allen key. Assembly shall conform to ASHREA / ANSI standard 102-1983.

Danfoss can accept no responsibility for possible errors in printed materials and reserves the right to alter its products without notice. All trademarks in this material are property of the respective companies. Danfoss and Danfoss logotype are trademarks of Danfoss A/S. All rights reserved.



Danfoss Inc.
6711 Mississauga Road, Suite 410
Mississauga, ON, L5N 2W3
Tel.: 905-285-2050, Fax: 905-285-2055
www.na.heating.danfoss.com

Danfoss Inc.
7941 Corporate Drive
Baltimore, MD 21236 USA
Tel.: 443-512-0266, Fax: 443-512-0270
www.na.heating.danfoss.com