



See
Initial start-up
instructions on page one

**COMMERCIAL
PRODUCTS™**

**Iron & Oak
20, 22, and 26 Ton
Vertical / Horizontal Log Splitters
Standard & DURO-GLIDE Models**

**Models: BHVH2209
BHVH2209FC
BHVH2609**



**Owner / Operator
and Safety Manual**

 **Made in U. S. A.**

Initial Start-Up Instructions

- Read all assembly, operating, and safety instructions.
- Complete and return the warranty card to register your log splitter.
- Write the serial number and date-of-purchase in this manual.
- Assemble the log splitter.
- Make sure the oil filter is properly installed. (See “Assembly Procedure” section.)
- Fill the hydraulic tank with the recommended type and quantity of oil. (See “Start-Up Procedure” section.)
- Fill the engine crankcase with the manufacturer’s recommended type and quantity of oil. (See “Start-Up Procedure” section.)
- Fill the engine fuel tank with fresh, clean, **lead-free** gasoline. (Do not mix oil with gasoline.)
- Bleed the air out of the cylinder before starting the log splitter. (See “Start-Up Procedure” section.)
- Make sure the trailer hitch of the towing vehicle is equipped with a 2 inch ball.

NOTE: Iron and Oak Commercial Products reserves the right to make technical changes for product improvement. This manual may contain illustrations and photographs, for demonstration purposes, which slightly deviate from the actual product design.

Serial Number _____

Date-of-Purchase _____

Please enter the serial number and purchase date of your log splitter in the space provided. Keep this manual for future reference.



IRON & OAK

BRAVE
PRODUCTS, INC.
Streator, IL

SERIAL No.

Made in U.S.A.

Contents

Introduction	4
Safety	5
Personal Protection	5
Worksite Safety	5
Operating Safety	6
Log Splitting Safety	7
Maintenance and Repair	7
Towing	8
Refueling	8
Preventing Fires	9
Assembly Instructions	10
Required Tools	10
Shipping List	10
Unpacking the Crate	11
Assembly Procedure	12
Start-Up Procedure	17
Towing	19
Operation	21
Operation - Horizontal Position	22
Operation - Vertical Position	25
Inspection and Maintenance	28
General Maintenance Check (before operating)	28
Engine Service	28
Storage	28
Hydraulic Oil Change	29
Specifications	31
Mechanical Specifications	31
Hydraulic Specifications	32
Replacement Filters	32
Hydraulic Oil Specifications (non foaming)	32
Troubleshooting	33
Decals	34
Parts	36
Warranty	44
Warranty Card	45
Optional Attachments	47
Log Cradle	47
Log Dislodger	47
Safety Flag Kit	48

WARNING



To avoid personal injury or death, carefully read and understand all instructions pertaining to the Iron & Oak Commercial Products' log splitter.

Do not attempt to assemble, operate, or maintain our product without fully understanding all our instructions and safety precautions. Do not operate the log splitter unless you read and understand the instructions and warnings in this manual. If any doubt or question arises about the correct or safe method of performing anything found in this or other Iron & Oak Commercial Products' manuals, contact your Iron & Oak Commercial Products' dealer or call the Sales and Service representatives at our main headquarters. Proper care is your responsibility.

WARNING

Accidents can often be avoided by being alert and recognizing potentially hazardous situations. Any individuals operating, maintaining, or repairing products manufactured by Iron & Oak Commercial Products should have the necessary training, skills, and tools required to perform these functions properly and safely. The safety information in this manual serves as a basic guide in an attempt to prevent injury or death.

Iron & Oak Commercial Products cannot anticipate every possible circumstance that might involve a potential hazard. The warnings in this manual and on the product itself are, therefore, not all inclusive. If tools, procedures, work methods, or operating techniques that are not specifically mentioned by Iron & Oak Commercial Products are used, you must satisfy yourself that they are safe for you and for others. Make sure the log splitter will not be damaged or made unsafe by any operation, lubrication, maintenance, or repair procedures that you choose.

DO NOT proceed if any doubt arises about the correct or safe method of performing anything found in this or other Iron & Oak Commercial Products' manuals. Seek out expert assistance from a qualified person before continuing.

WARNING

CALIFORNIA PROPOSITION 65

Engine exhaust from this product contains chemicals known to the State of California to cause cancer, birth defects, or other reproductive harm.

Introduction

The commercial BHVH2209, BHVH2209FC, and BHVH2609 Vertical/Horizontal Log Splitters are designed for tough applications in both vertical and horizontal positions. With 22 tons (model BHVH2209) or 26 tons (model BHVH2609) of splitting force, a 12 second cycle time, and a 6 HP or an 9 HP engine either model will handle most of your commercial log splitting needs. The BHVH2209FC features an 8 second cycle time, 20 tons of splitting force, and an 9 HP engine.

The DURO-GLIDE rail/wedge system, if equipped, provides the longest possible wear life of the sliding wedge. Composite material wear pads built into the wedge provide more efficient splitting, more splitting power, and eliminates metal-to-metal contact.

An attractive, powder-coated finish provides the finest protection available, and Iron & Oak's rigid, quality-control and component testing help ensure years of productive, reliable service. Since 1982, the name Iron & Oak has stood for quality and reliability when it comes to log splitters and wood processing products.

Iron & Oak Commercial Products offers the finest commercial log splitter on the market today!







- ✓ Rugged, heavy-duty construction for years of exceptional service.
- ✓ Ergonomic design for use in vertical and horizontal operating positions.
- ✓ Rigid, quality-control during manufacturing ensures greater reliability.
- ✓ Factory testing of all major components and hydraulic tank.
- ✓ Powder-coated finish for the best appearance and weather protection.
- ✓ Year-round manufacturing, parts, and support.

For additional information, contact us at:







Iron & Oak Commercial Products
410 W. Broadway Ave.
P.O. Box 577
Streator, Illinois 61364-0577
Phone: (815) 672-8596
Fax: (815) 672-9073
E-mail: sales@logsplitters-ironoak.com
Web Site: www.logsplitters-ironoak.com

The following is a list of safety rules you must follow in order to use your log splitter safely.

Personal Protection













- ✓  To avoid personal injury or death, carefully read and understand all instructions pertaining to the log splitter including the engine manufacturer's operating and maintenance instruction manual.
- ✓      Always wear protective gear, such as safety goggles, tight-fitting gloves without draw strings or loose cuffs, steel-toed shoes, and a protective hearing device.
- ✓  To prevent injury, make sure all decals are attached to the log splitter and are legible at all times.

Worksite Safety

- ✓  To avoid tripping, do not leave tools, logs, or other components laying around the work area.
- ✗  NEVER operate your log splitter on slippery, wet, muddy, or icy surfaces. The location you choose should be flat, dry, and free from any tall grass, brush, or other interferences.
- ✗  NEVER operate the engine in an enclosed area. Exhaust fumes contain carbon monoxide that can be deadly when inhaled. Make sure the area is well ventilated.
- ✗  NEVER attempt to move your log splitter over hilly or uneven terrain without a tow vehicle.
- ✗  NEVER use your log splitter at night.
- ✓  ALWAYS operate your log splitter on dry, solid, level ground.
- ✓  ALWAYS block the wheels to prevent movement of the machine while in operation.





Safety

Operating Safety









- ✓  ALLOW ONLY ONE (1) PERSON TO LOAD AND OPERATE THE LOG SPLITTER.
- ✓  Allow only adults to operate the log splitter. No one under the age of 18 should be allowed to operate the log splitter.
- ✓  Always keep bystanders, including children and pets, at least twenty-five (25) feet away from the work area. Only the operator should stand near the equipment and only within the safe operating area prescribed in this manual (see the photos on safe and unsafe operating zones in the “Operation” section.)
- ✓  When the ram of the log splitter is in the return mode, keep your hands off the machine — the log splitter is designed to automatically stop when the cylinder is fully retracted.
- ✓  ALWAYS disconnect the spark plug wire when the log splitter is not in operation.
- ✗  Do not allow any person to operate the log splitter until they have read and understood the safe operating instructions contained in this manual.
- ✗  Do not, under any circumstances, alter your log splitter. This equipment was designed and engineered to be used in accordance with the operating instructions. Altering the equipment, or using the equipment in such a way as to circumvent its design capabilities and capacities, could result in serious or fatal injury and WILL VOID THE WARRANTY.
- ✗  Never operate, or allow anyone else to operate, this equipment while under the influence of medication, drugs, or alcohol.
- ✗  Never wear loose clothing or jewelry that may get caught or become entangled in the log splitter.
- ✗  NEVER place hands or feet between log and splitting wedge or between log and ram during the forward or reverse stroke.
- ✗  DO NOT STRADDLE OR REACH ACROSS THE SPLITTING AREA WHEN OPERATING THE LOG SPLITTER.
- ✗  Do not step over your log splitter when the engine is running, because you may trip or accidentally engage the ram.
- ✗  NEVER attempt to load your log splitter while the ram is in motion.

- ✗  Only use your hand to operate the control lever. NEVER use your foot, knee, a rope, or any other extension device.

Log Splitting Safety









- ✓  Always keep your fingers away from any cracks that open in the log during the splitting operation.
- ✓  ALWAYS make sure that both ends of the log you are splitting are cut as square as possible. This will prevent the log from sliding out of position while under pressure. Logs should be 24 inches or shorter in length.
- ✗  NEVER try to split two logs on top of each other.
- ✗  Never pile logs to be split in a manner that will cause you to reach across the log splitter.

Maintenance and Repair





- ✓  Follow all safety rules, because most accidents involving the operation, maintenance, or repair of products occur because the assembler/owner/operator failed to observe basic safety rules or operating instructions.
- ✓  ALWAYS inspect your log splitter before each use. Make sure all nuts, bolts, screws, hydraulic fittings, hose clamps, etc. are securely tightened.
- ✓  ALWAYS check the oil level in the hydraulic oil tank and engine reservoir.
- ✗  NEVER operate your log splitter when it is in need of repair or is in poor mechanical condition.
- ✗  NEVER tamper with the engine to run it at excessive speeds. The maximum engine speed is preset and is within safety limits.
- ✗  NEVER make alterations to your log splitter in any manner. Such alterations may cause the log splitter to become unsafe and **WILL VOID THE WARRANTY.**
- ✗  NEVER attach a rope or extension to the control lever or add width or height to the splitting wedge. Such **ALTERATIONS** may cause the log splitter to become **UNSAFE** and **WILL VOID THE WARRANTY.**
- ✗  ALWAYS clean the unit after each use. If possible, store the unit inside or cover it completely, if stored outside.





Safety

Towing



- ✓  ALWAYS check before towing to make certain your log splitter is correctly and securely attached to the towing vehicle. Be sure that the ball hitch you are using is the proper size for the hitch coupler on the log splitter (see “Specification” section). Be sure the safety chains are properly hooked to the vehicle leaving enough slack for turning.
- ✓  ALWAYS allow for added length of the log splitter when turning, parking, crossing intersections, and in all driving situations.
- ✓  ALWAYS be careful when backing up. You could jackknife your log splitter if care is not taken.
- ✓  ALWAYS disconnect your log splitter from your towing vehicle before attempting to use it.
- ✗  NEVER exceed 35 m.p.h. when towing your log splitter. Obey all state and local regulations when towing on state and local roads and highways. Adjust your speed for terrain and conditions, as needed. Be extra cautious when towing over rough terrain, especially over a railroad crossing.
- ✗  NEVER tow your log splitter when there is fuel in the engine’s tank.
- ✗  NEVER allow anyone to sit or ride on your log splitter.
- ✗  NEVER carry any cargo or wood on your log splitter.

Refueling

- ✓  ONLY refuel the log splitter outdoors in a clear area void of gas fumes or spilled gasoline.
- ✓  ALWAYS use an approved fuel container to carry gasoline.
- ✓  ALWAYS replace the log splitter gas cap and the fuel container cap securely.
- ✓  If gasoline is spilled, move the machine away from the area of the spill and avoid creating any source of ignition until the spilled gasoline has completely evaporated.
- ✓  Take a class B fire extinguisher with you when operating the log splitter in dry areas as a precautionary measure against possible flying sparks.

- ✓  Always store gasoline in an approved, tightly sealed container. Store the container in a cool, dry place. Do not store the container in a house or near any heating appliance.
- ✗   Do not smoke or have open flames when refueling the engine. Do not spill fuel. If fuel should spill, quickly wipe up the spill and allow the excess to evaporate before continuing. Make sure gasoline soaked rags are properly disposed of.
- ✗  DO NOT fill the gas tank while the engine is hot or running. Allow time for the engine to cool down before refueling.

Preventing Fires

- ✗  NEVER operate the log splitter near a flame or spark. Oil and gasoline are flammable and can explode.
- ✗  NEVER smoke while operating or refueling the log splitter. Gasoline, oil, and even gas fumes can explode.

Important Notice

The log splitter is equipped with an internal combustion engine and should not be used on or near any unimproved forest-covered, brush-covered, or grass-covered land unless the engine's exhaust system is equipped with a spark arrester meeting local or state laws (if any). If a spark arrester is used, it should be maintained in effective working order by the owner and/or operator.

Assembly Instructions

Required Tools

- 10" crescent wrench
- Flat head screwdriver
- Two 1/2" open end wrenches
- Two 3/4" open end wrenches
- Funnel
- Pliers
- Band Cutters

Shipping List

The following chart contains the list of parts that should be shipped as part of the BHVH2209, BHVH2209FC, or BHVH2609 Log Splitter.

Qty	Description	Qty	Description
1	Base Unit (engine) ¹		Rail to Base Assembly
1	Rail Unit (hydraulic cylinder) ¹	2	Bolts (1/2-13 x 1-1/2 inch) ²
1	Oil Filter ²	2	Lockwashers (1/2") ²
	Hitch Assembly Parts	2	Nuts (1/2-13) ²
1	Hitch Assembly (2 inch) ²		Rail Latch Assembly
2	Bolt (1/2-13 x 3-1/2 inch) ²	1	Rail Latch Assembly
2	Locknuts (1/2-13) ²	2	Bolts (1/2-13 x 1-1/2 inch) ²
2	Safety Chains ²	2	Lockwashers (1/2 inch) ²
1	Safety Link ²	2	Nuts (1/2-13) ²
	Tongue and Front Leg Assembly		Valve Assembly
1	Tongue and Front Leg Weldment ¹	1	Control Lever (valve) ²
2	Bolts (1/2-13 x 3-1/2 inch) ²	1	Knob (valve lever) ²
2	Locknuts (1/2-13) ²	1	Valve Link ²
		3	Clevis Pins ²
		3	Cotter Pins ²
			Fender Assembly
		2	Fenders ²
		4	Bolts (5/16-18 x 3/4 inch) ²
		4	Locknuts (5/16-18) ²

¹ On the pallet.

² In cardboard box.

Unpacking the Crate

1. Cut the metal banding and remove the top, sides, ends, and protective plastic covering of the packing crate. Do not remove the base unit or the rail assembly from the bottom pallet at this time.

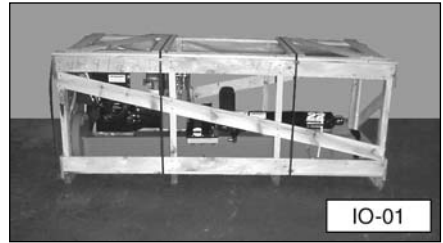

2. Carefully check the larger components on the shipping pallet for damage. If the parts are damaged call Iron & Oak Products at (815) 672-8596.

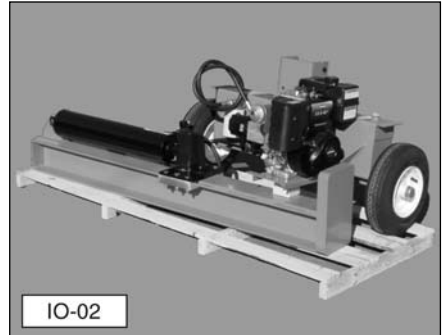

3. Cut the remaining banding straps, open the cardboard box, and make sure all the smaller parts have been shipped. The chart in the "Shipping List" section provides a complete list of all the parts shipped with your log splitter. If any parts are missing call Iron & Oak Products at (815) 672-8596.



NOTE: The contents of the cardboard box contains the hitch assembly, two safety chains and safety link, two fenders, valve handle assembly, filter element, and rail rest assembly. Also, included in the box is a plastic bag of miscellaneous hardware and a plastic bag with the valve handle, knob, valve link, clevis pins, and cotter pins.

Assembly Instructions

Assembly Procedure

⚠ CAUTION



Some components are very heavy and can be damaged if mishandled. Also, to help prevent personal injury, it is strongly recommended that two (2) people work together to uncrate and assemble the log splitter.

1.  Remove and read all instructions and safety recommendations before assembling or operating this log splitter.
2. Before removing the base unit from the pallet, remove the tongue and front leg assembly and install it to the base unit using two 1/2-13 x 3-1/2 inch long hex head bolts and locknuts. Tighten the nuts securely. Roll the tongue/base unit off the pallet. Lower the front leg and lock it into position.

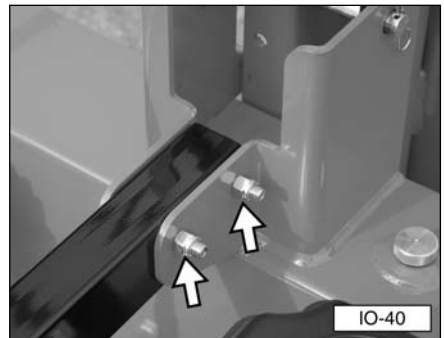
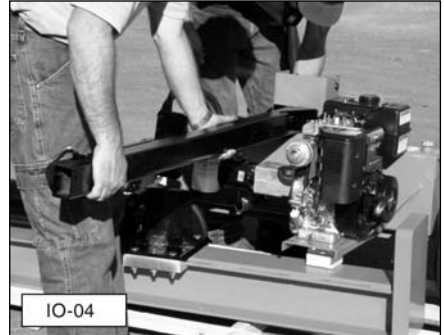

⚠ WARNING

Make sure the rail assembly is standing on a flat, level area. Have a helper steady the rail to prevent it from tipping over. The rail assembly weighs approximately 300 pounds and will cause bodily injury if it falls on someone.

3. Carefully stand the rail assembly in an upright, vertical position.
4. Carefully align the hinge brackets in the base unit with the third hole from the base plate in the rail assembly.

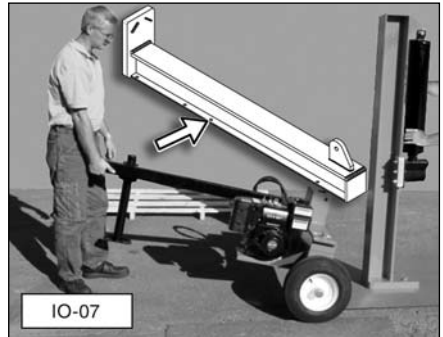
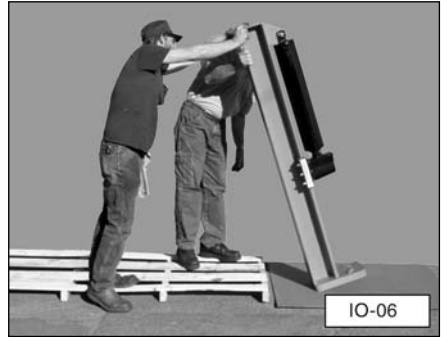

NOTE: If also installing an optional BR021180 Log Cradle, assemble it at this time. The log cradle uses the first and third holes.

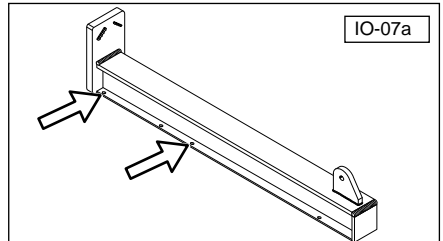

5. Bolt the base unit to the rail assembly using two 1/2-13 x 1-1/2 inch long hex head bolts, lockwashers, and nuts, as shown. Hand tighten the nuts.

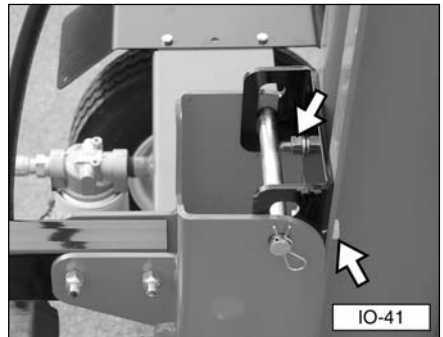

Assembly Instructions

6. Bolt the rail rest to the rail assembly using two 1/2-13 x 1-1/2 inch long hex head bolts, lockwashers, and nuts, as shown. Hand tighten the nuts.

Pull the latch mechanism outward and rotate the handle to hold the lock pin in the unlocked position.



7. Block the wheels to prevent the base unit from moving. Carefully lower the rail assembly to a horizontal position. Securely tighten the nuts holding the base unit to the rail assembly (Step 5) and the nuts holding the rail rest assembly (Step 6).



8. Link the ends of safety chains together with the safety quick-link and tighten the link's locknut securely with a wrench.

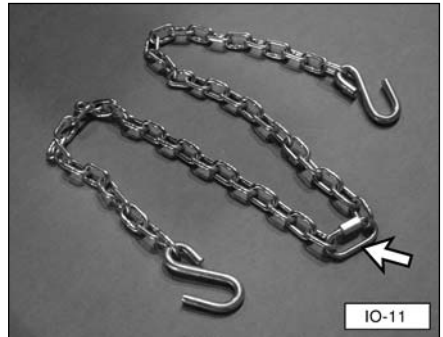

9. Place the hitch over the attachment tube, aligning the bolt holes, and insert the rear 1/2-13 x 3-1/2 inch bolt (A). Install and tighten the locknut.

Insert the end of quick link into front tube of the rail assembly and insert a 1/2-13 x 3-1/2 inch bolt (B) through link and hitch. Install and tighten the locknut.

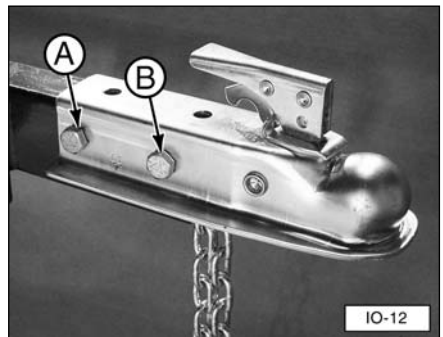

Assembly Instructions

10. Install the valve link onto the valve body, as shown, using a 1/4 x 1 inch long clevis pin. Secure the clevis pin with a cotter pin (bend the ends of the cotter pin to make it secure).

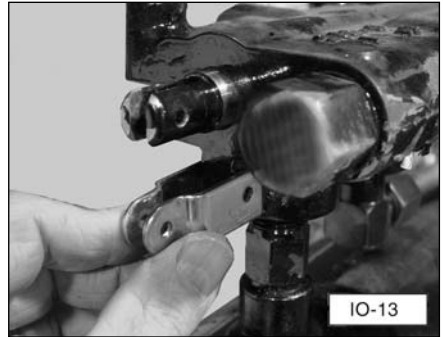

11. Install the valve handle onto the valve link using a 1/4 x 3/4 inch long clevis pin. Secure the clevis pin with a cotter pin (bend the ends of the cotter pin to make it secure).

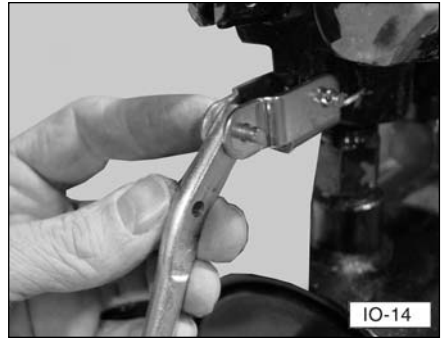

12. Attach the valve handle to the valve spool using a 1/4 x 1 inch long clevis pin. Secure the clevis pin with a cotter pin (bend the ends of the cotter pin to make it secure). Attach the knob to the valve handle, if necessary.

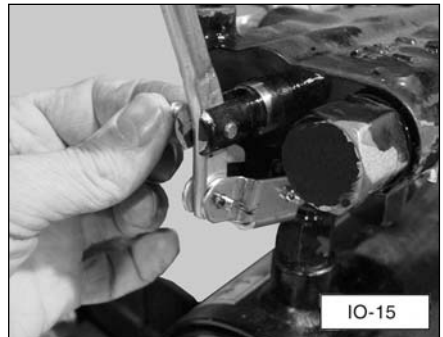

13. Attach the high-pressure hose from the filter assembly to the fitting on the side of the valve. Securely tighten the hose fitting.

NOTE: The high-pressure hose is self-sealing and does not require any type of sealing material. Tighten the fitting with a 10 inch crescent wrench.



Assembly Instructions

14. Coat the threads of the fitting with a hydraulic pipe sealant and attach the high-pressure hose from the bottom valve fitting to the pump, as shown. Securely tighten the hose fitting.



15. Remove the oil filter from the plastic cover and apply a thin coat of oil to the rubber seal. Screw the filter onto the filter head, located near the hydraulic tank. Once the filter makes contact with the filter head, turn it an additional 3/4 turn. Hand-tighten only.



16. Bolt the fenders onto the fender brackets using two 5/16-18 x 3/4 inch long hex head bolts and locknuts. The fenders are interchangeable (left or right). Position the fender over the tire with equal spacing in the front and back.



17. The log splitter is now completely assembled. **Follow the “Start-Up Procedure” in the following section, which adds oil to the engine and hydraulic tank before trying to start the engine.**



Important Notice

*Do not start the engine. **Follow all of the instructions in the “Start-up Procedure” before operating the log splitter.** Failure to follow this recommendation will result in engine and hydraulic pump damage.*

If this log splitter is purchased without an engine, the customer assumes all liabilities that might arise from an engine that is incompatible with the design of the log splitter. Also, any unauthorized changes or modifications to the log splitter will void all warranties.

IMPORTANT: The hydraulic system oil filter, for your log splitter, is not factory installed. Make sure the filter is installed before attempting to fill the hydraulic tank or start the engine. (Installation instructions are provided in the “Assembly Instructions” section and are also printed on the side of the filter).

IMPORTANT: Before starting the engine, read the engine manufacturer’s operating and maintenance instruction manual. If an engine manual was not supplied with the log splitter, it is your responsibility to obtain a manual. Start by contacting the store where you purchased the log splitter. If they cannot help you, contact the engine manufacturer.

1. Fill the hydraulic tank with SAE 10W tractor hydraulic oil or automatic transmission fluid, such as Dextron III. The tank is full when the oil level is approximately one inch from the top of the tank. Do not tighten the fill cap at this time.

NOTE: The total hydraulic system oil capacity for all units is 9.5 gallons.

2. Fill the engine’s crank case with the engine manufacturer’s recommended oil.

3. Lubricate the surface of slide rail with grease. This will help to prevent wear between the slide plates and the slide rail.

4. Remove the spark plug wire from the engine. This prevents the engine from starting until the hydraulic pump and cylinder are completely filled with oil. Make sure the spark plug wire is held away from the spark plug with string or other nonconductive material.

5. Push the valve control handle to the forward position (towards the front of the cylinder) with one hand. Pull the engine starter cord (about 15 times) with the other hand, until the cylinder piston moves forward. (Keep everything away from the splitting wedge during this step.)

NOTE: Extending the cylinder draws the hydraulic fluid through the system and expels any trapped air in the cylinder.

Start-Up Procedure

6. Check the fluid level in the hydraulic tank and add oil as needed.

WARNING



Be careful not to spill fuel when filling the engine. If fuel should spill, quickly wipe off and allow the excess fuel to evaporate before continuing. Fuel and fuel vapors are highly flammable and can cause personal injury or even death when ignited.

Important Notice

If your log splitter is equipped with a factory installed engine, do not mix oil with the gasoline. Using mixed oil/gasoline in a four cycle engine can cause engine damage.

7. Fill the engine's fuel tank with fresh, clean, lead-free automotive gasoline.
8. Attach the spark plug wire and start the engine per the manufacturer's instructions.
9. With the engine running, push the valve control handle to the retract position and retract the cylinder piston. The cylinder valve will automatically stop the cylinder from retracting when it reaches the end of its stroke. Cycle the log splitter several times.
10. Again, check the fluid level in the hydraulic tank and add oil as needed. Replace and tighten the fill cap.
11. Your log splitter is now ready to use.

⚠ WARNING

Maximum Speed Limit — 35 mph

Your log splitter is built on a solid, unsuspended axle. To prevent damage or possible loss of vehicle control, use extreme caution when towing and do not exceed a vehicle speed of 35 mph, especially when driving on a bumpy road.

1. Position the hitch coupler of the log splitter over or onto the tow vehicle's tow ball. In some cases, the hitch coupler may not totally engage with the tow ball without raising the jack leg assembly. Pull the latch assembly on the hitch coupler up and into the open position.

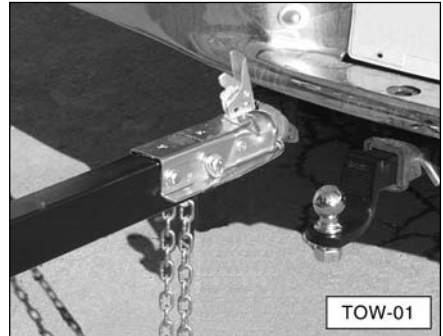

2. Release the latch assembly on the hitch coupler and lock the hitch coupler onto the tow ball. Attach the towing safety chains to the tow vehicle.



3. Raise the front leg to the towing position by pulling the spring pin. If not already secure, make sure the hitch coupler is properly and securely attached to the tow ball.



Towing

4. Place a customer supplied lock or lock pin into the latch assembly of the hitch coupler.

⚠ WARNING

Making sure the log splitter is securely attached to the vehicle is the responsibility of the owner/operator. Failure to securely attach the log splitter can cause loss of control of the vehicle or the log splitter being separated from the towing vehicle, resulting in serious injury or death.

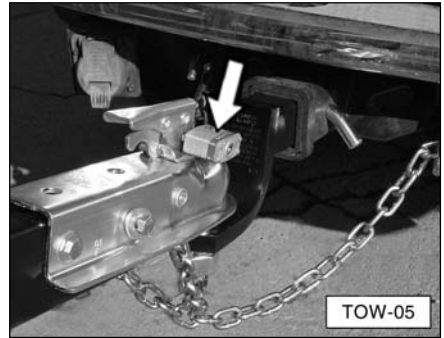

WARNING



Do not attempt to operate the log splitter without fully understanding all our instructions, safety precautions, and/or warnings. If any doubt or question arises about the correct or safe method of performing anything found in this or other Iron & Oak Products' manuals, contact your Iron & Oak Products' dealer or call the Sales and Service representatives at our main headquarters. Proper care is your responsibility.

When operating the log splitter, make sure you are standing in the **safe operating area**, as shown in these pictures. You must stay in the **safe operating area** at all times when the splitting wedge is in motion (whether extending or retracting). Never place any part of your body into a position that causes an unsafe operating condition.

1. Set your log splitter on flat, dry ground. Make sure you read all the recommendations from the "Safety" section before using the log splitter.
2. Make sure both ends of the log you are splitting are cut as square as possible. This will prevent the log from sliding out of position while under pressure. All logs should be 24 inches long or shorter.

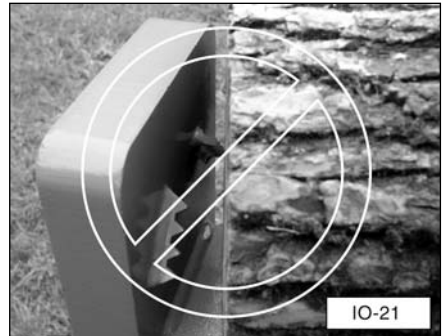

WARNING

Never attempt to split wood across the grain. The log splitter was not designed for cross-grain splitting. Doing so will damage the log splitter and may cause personal injury.

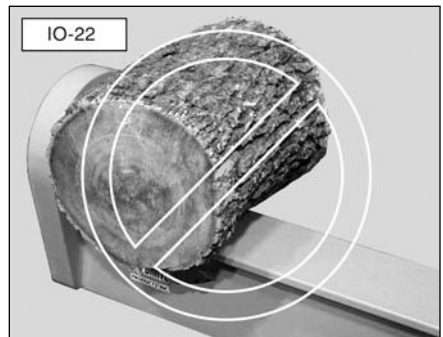

Operation

3. Start the engine using the instructions from the engine manual. If the log splitter has not been running (cold engine), warm up the engine and hydraulic system by running the engine at half throttle for 3 to 4 minutes, then advance the engine throttle control to maximum speed.

Operation – Horizontal Position

WARNING



Before loading and operating the log splitter, always wear protective gear, such as safety goggles, face shield, hearing protection, tight-fitting gloves without draw strings or loose cuffs, and steel-toed shoes.

4. Use the following photos for the correct and incorrect methods of splitting logs. Never split a log using an incorrect or unsafe method.

- a. Place the log on the log splitter. Grasp the log on the sides near the middle of the block. Center the log, side-to-side, on the rail of the log splitter, making sure that the sawed end is against the large plate (base plate) at the opposite end of the hydraulic control valve control lever.



CAUTION



Do not place your hands on the ends of the log when loading the log splitter. This is a very **UNSAFE** method and could result in injury to your hands.



- b. Only using your hand, push the control lever forward (towards the log). If the log moves, before it is contacted by the splitting wedge, release the control lever and then reposition the log. Operate the log splitter only when standing in the **safe operating area**, shown in the picture.

⚠ CAUTION



Make sure you stand clear from the engine's exhaust. Hot exhaust is intense and can cause serious injury.



⚠ CAUTION



If you find you must hold the log until the wedge touches it and holds it in place, be very careful not to put your hand between the log and the end plate or the log and the wedge. If you must, hold the log on top and in the middle. Remove your hand immediately when the splitting wedge engages the log. Never use your hip or any extension device to operate the valve control handle.



⚠ WARNING



Do not operate the log splitter by reaching across the rail. This is a very **UNSAFE** method which could cause personal injury or even death.

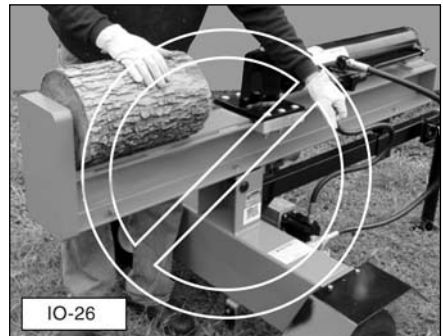

⚠ WARNING



Do not reach or step across the rail while the log splitter is running. This is a very **UNSAFE** method which could cause personal injury or even death.

Operation

- c. Hold the control lever, extending the splitting wedge, until the log is split or the cylinder rod stops at its maximum travel position. Stop the log splitter (forward movement), at any point in the splitting process, if you feel an unsafe log splitting condition is occurring. As the log is being split, **DO NOT** reach forward and attempt to catch the split wood — let it fall to the ground.



- d. Once the wedge reaches its full forward travel, pull back on the control lever to the full retract position. The ram of the cylinder will automatically retract into the cylinder. It is not necessary to hold the control lever as the cylinder retracts. Stop the wedge if the log sticks (see caution below). When the cylinder is fully retracted, the control valve will automatically shift to a neutral position.

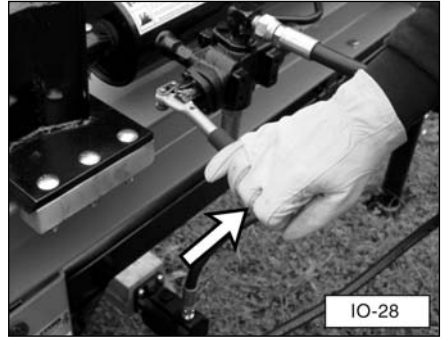

- e. **DO NOT** load another log or remove split pieces until the wedge has completely stopped and the control handle automatically returns to the neutral position.

⚠ CAUTION



Depending on the type of wood being split, a log may not always break into two pieces and fall to the ground. If a log sticks to the wedge, place the valve handle in the neutral position (stop the wedge from retracting) and carefully remove the log from the wedge. Allowing the log to remain attached to the wedge when it is fully retracted could lead to possible injury and/or damage to the log splitter.

Operation – Vertical Position

WARNING



Before loading and operating the log splitter, always wear protective gear, such as safety goggles, face shield, hearing protection, tight-fitting gloves without draw strings or loose cuffs, and steel-toed shoes.

5. Use the following photos for the correct and incorrect methods of splitting logs. Never split a log using an incorrect or unsafe method.

- a. To operate the log splitter in a vertical position, pull the spring-loaded locking lever and twist the locking lever either direction to lock it in the “unlocked” position.

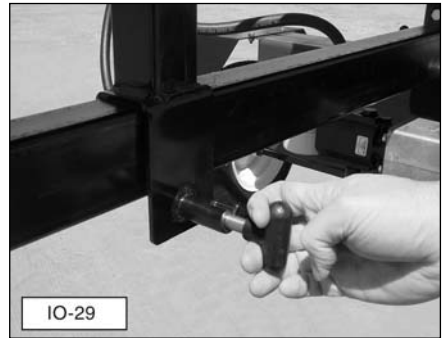

- b. Block the wheels and stand the rail assembly up into a vertical position.



- c. Turn the spring-loaded locking lever knob until the pin slides into the slot. This allows the plunger to snap into place, securing the rail assembly in a vertical position.

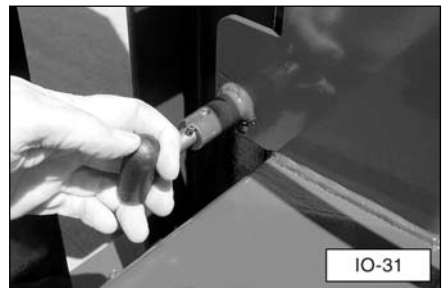

Operation

- d. Move the log under the splitting wedge keeping your hands on the sides of the log near the middle of the block. Center the log making sure that the sawed end is sitting on the large plate (base plate).

⚠ CAUTION



Make sure you stand clear from the engine's exhaust. Hot exhaust is intense and can cause serious injury.



IO-32

⚠ CAUTION



Do not place your hands on top of the log when loading the log splitter. This is a very UNSAFE method and could result in injury to your hands.



IO-33

⚠ CAUTION



If you find you must hold the log until the wedge touches it and holds it in place, be very careful not to put your hand on top of the log. If you must, hold the log in the middle of the block. Remove your hand immediately when the wedge engages the log. Never use your hip or any extension device to operate the valve control handle.



IO-34

- e. Only using your hand, push the control lever down (towards the log). If the log moves, before it is contacted by the splitting wedge, release the control lever and then reposition the log. Operate the log splitter only when standing in the **safe operating area**, as shown in the picture.



IO-32

- f. Hold the control lever, extending the splitting wedge, until the log is split or the cylinder rod stops at its maximum travel position. Stop the log splitter (forward movement), at any point in the splitting process, if you feel an unsafe log splitting condition is occurring. As the log is being split, DO NOT reach forward and attempt to catch the split wood — let it fall to the ground.

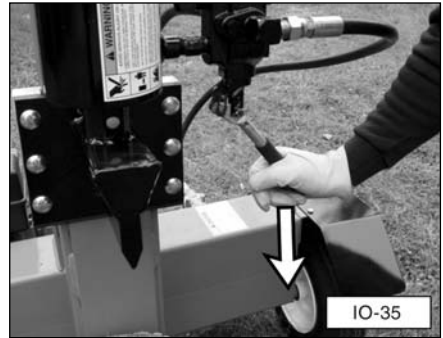

- g. Once the wedge reaches its full forward travel, pull back on the control lever to the full retract position. The ram of the cylinder will automatically retract into the cylinder. It is not necessary to hold the control lever as the cylinder retracts. Stop the wedge if the log sticks (see caution below). When the cylinder is fully retracted, the control valve will automatically shift to a neutral position.

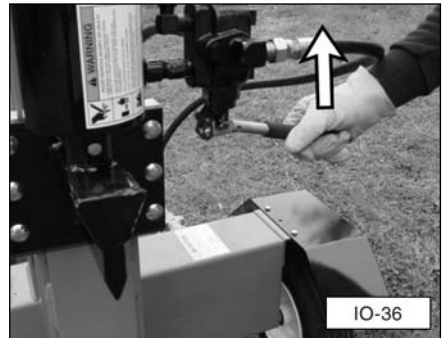

- h. DO NOT load another log or remove split pieces until the wedge has completely stopped and the control handle automatically returns to the neutral position.

⚠ CAUTION



Depending on the type of wood being split, a log may not always break into two pieces and fall to the ground. If a log sticks to the wedge, place the valve handle in the neutral position (stop the wedge from retracting) and carefully remove the log from the wedge. Allowing the log to remain attached to the wedge when it is fully retracted could lead to possible injury and/or damage to the log splitter.

Inspection and Maintenance

General Maintenance Check (before operating)

The hydraulic system (hoses, cylinder, and pump) should be carefully inspected before each use. Also, inspect the mechanical parts at the same time. Make sure all clamps, nuts, bolts, fittings, etc. are properly installed and tightened.

WARNING



Do not check for leaks with your hand. Leaks can be located by passing a piece of cardboard or wood around the suspected leak and looking for discoloration. High-pressure fluid escaping from a very small hole can be almost invisible. Escaping fluid under pressure can have sufficient force to penetrate skin, causing serious injury or even death. If fluid is injected into your skin, it must be treated immediately by a doctor familiar with this type of injury.

Always replace frayed, kinked, or cracked hoses and/or other damaged hydraulic components with Iron & Oak Commercial Products authorized parts and components specified in the “Parts” section of this manual. Replacement parts from secondary suppliers (not original Iron and Oak replacement parts) can lead to product damage and/or personal injury, and will void the warranty.

CAUTION



Do not remove the cap from the hydraulic tank or reservoir while the log splitter is running. Hot oil, under pressure, could be expelled resulting in serious injury.

Should it become necessary to loosen or remove any hydraulic fitting or line, be sure to relieve all hydraulic pressure by shutting off the engine, removing spark plug wire, and moving the valve control handle back and forth several times until no cylinder movement is visible.

Engine Service

Refer to the engine manufacturers’ manual for engine maintenance and repair.

Storage

Between each use of the log splitter, we recommend applying a rust preventative (WD-40 or equivalent) to any bare metal areas on the top of the rail. This will assure the longest possible service life of the wear pads.

Refer to the engine manufacturer's manual for engine storage.

Hydraulic Oil Change

Iron & Oak Commercial Products recommends an oil and filter change every 100 hours of operation. Refer to the “Specifications” section, in this manual, for the type and quantity of oil.

Important Notice

Never run the log splitter unless the hydraulic oil tank is full.

1. Drain the head end of the cylinder.

- a. Remove the spark plug wire and spark plug to help reduce the back pressure on the engine and to prevent it from starting.
- b. Disconnect return hose (1) from the oil filter housing and place it in a waste oil container. (Please properly dispose of the waste oil per local regulations.)
- c. Extend the cylinder by holding the valve handle forward and pulling on the engine’s pull start cord until oil from the return line stops flowing. This step drains the head end of the cylinder.

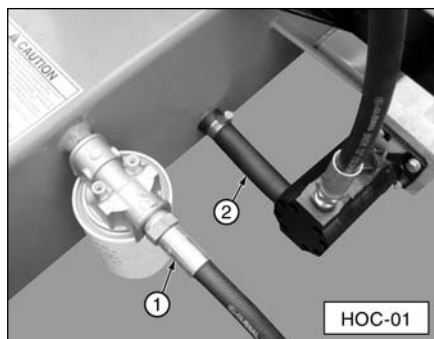

2. Drain the hydraulic tank.

- a. Place a waste oil container under inlet hose (2).
- b. Remove the inlet hose from the pump.
- c. Slightly lower the front of the log splitter to completely drain the tank.

3. Remove and replace the oil filter.

- a. Remove the existing oil filter and properly dispose of it.
- b. Apply a thin coat of oil to the rubber seal of the new oil filter.
- c. Screw the filter onto the filter head. Once the filter makes contact with the filter head, turn it an additional 3/4 turn. Hand-tighten only.



Inspection and Maintenance

4. Refill the hydraulic tank.
 - a. Reconnect inlet hose (2) to the pump.
 - b. Remove the hydraulic tank fill cap and fill the tank with the recommended type and quantity of oil. Replace the cap.
5. Drain and refill the piston end of the cylinder.
 - a. Hold the valve handle in the retract position and pull the engine pull start cord until the rod is fully retracted. This step removes the old oil from the piston end of the cylinder.
 - b. Reconnect return hose (1) to the oil filter.
 - c. Extend the cylinder by holding the valve handle forward and pulling on the engine's pull start cord until the cylinder is completely extended. This step refills the piston end of the cylinder.
6. Start the engine and cycle the cylinder.
 - a. Replace the spark plug and spark plug wire.
 - b. Start the engine and cycle the cylinder several times.
 - c. Retract the cylinder and shut off the engine.
 - d. Recheck the hydraulic tank to make sure oil is filled within approximately one inch from the top of the tank.

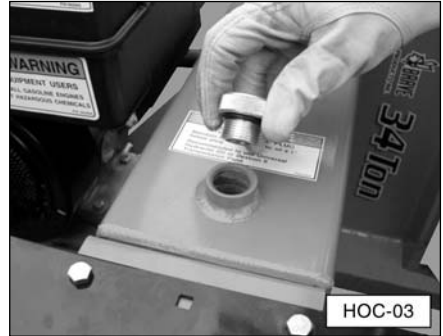

Mechanical Specifications (Model BHVH2209)

Beam	6 inch heavy-duty, formed steel beam
Wedge	6" high carbon steel, compound angle (replaceable)
Beam & wedge (DURO-GLIDE)	Formed steel beam with 1/2" x 6" top plate, close-tolerance, cold rolled steel. Precision machined wedge with 12 composite guides inset into the wedge, side guides, and retainer plates (replaceable).
Force/Tonnage	22 ton
Cylinder Stroke	24 inches
Log Opening	25 inch maximum
Cycle Time	12 seconds (approx.)
Operating Positions	Vertical/Horizontal
Wheels & Tires	High-Speed, 4.80 x 8" (Bolt-on)
Safety Chains	Standard
Hitch Coupler	2" locking ball (Standard)
Standard Engine	6.5 HP IC Briggs & Stratton
Optional Engines	6.5 HP std B & S, 5.5 HP Honda, 6 HP Robin, 6.5 HP Vanguard

Mechanical Specifications (Model BHVH2209FC)

Beam	6 inch heavy-duty, formed steel beam
Wedge	6" high carbon steel, compound angle (replaceable)
Beam & wedge (DURO-GLIDE)	Formed steel beam with 1/2" x 6" top plate, close-tolerance, cold rolled steel. Precision machined wedge with 12 composite guides inset into the wedge, side guides, and retainer plates (replaceable).
Force/Tonnage	20 ton
Cylinder Stroke	24 inches
Log Opening	25 inch maximum
Cycle Time	8 seconds (approx.)
Operating Positions	Vertical/Horizontal
Wheels & Tires	High-Speed, 4.80 x 4.00 x 8" (Bolt-on)
Safety Chains	Standard
Hitch Coupler	2" locking ball (Standard)
Standard Engine	11 HP IC Briggs & Stratton
Optional Engines	11 HP std B & S, 9 HP Honda, 9 HP Robin, 9 HP Vanguard

Mechanical Specifications (Model BHVH2609)

Beam	6 inch heavy-duty, formed steel beam
Wedge	6" high carbon steel, compound angle (replaceable)
Beam & wedge (DURO-GLIDE)	Formed steel beam with 1/2" x 6" top plate, close-tolerance, cold rolled steel. Precision machined wedge with 12 composite guides inset into the wedge, side guides, and retainer plates (replaceable).
Force/Tonnage	26 ton
Cylinder Stroke	24 inches
Log Opening	25 inch maximum
Cycle Time	12 seconds (approx.)
Operating Positions	Vertical/Horizontal
Wheels & Tires	High-Speed, 4.80 x 4.00 x 8" (Bolt-on)
Safety Chains	Standard
Hitch Coupler	2" locking ball (Standard)
Standard Engine	11 HP IC Briggs & Stratton
Optional Engines	11 HP std B & S, 9 HP Honda, 9 HP Robin, 9 HP Vanguard

Specifications

Hydraulic Specifications (Model BHVH2209)

Cylinder Size	4 x 24 inch, clevis type cylinder with 1 3/4 inch rod
Hydraulic Tank Capacity	7.5 gallons
Hydraulic System Capacity (incl. cylinder, tank, hoses, and filter)	9.5 gallons
Hydraulic Oil Filter	Spin-on, 25 micron filter
Safety Release Control Valve	Detent, auto return
Gear Pump	2-stage, 11 GPM
Shipping Weight	635 to 660 lbs.

Hydraulic Specifications (Model BHVH2209FC)

Cylinder Size	3.5 x 24 inch, clevis type cylinder with 1 3/4 inch rod
Hydraulic Tank Capacity	7.5 gallons
Hydraulic System Capacity (including cylinder, tank, hoses, and filter)	9.5 gallons
Hydraulic Oil Filter	Spin-on, 25 micron filter
Safety Release Control Valve	Detent, auto return
Gear Pump	2-stage, 16 GPM
Shipping Weight	660 to 690 lbs.

Hydraulic Specifications (Model BHVH2609)

Cylinder Size	4.5 x 24 inch, clevis type cylinder with 2 inch rod
Hydraulic Tank Capacity	7.5 gallons
Hydraulic System Capacity (including cylinder, tank, hoses, and filter)	9.5 gallons
Hydraulic Oil Filter	Spin-on, 25 micron filter
Safety Release Control Valve	Detent, auto return
Gear Pump	2-stage, 16 GPM
Shipping Weight	700 lbs.

Replacement Filters

Replacement Filters	NAPA 1553
	FRAM PF1654
	WIX 51552

Hydraulic Oil Specifications (non foaming)

Tractor Hydraulic Oil	
For extremely cold weather conditions	SAE 10W
For extremely warm weather conditions	SAE 30W
Transmission Fluid	Dextron III

Important Notice

DO NOT mix tractor hydraulic oil with transmission fluid. Use one or the other.

The following section will detail procedures for checking your log splitter, should you encounter a malfunction. We recommend that you do not attempt to make repairs to the log splitter. In the long run, it is better to take your log splitter to a servicing lawn and garden dealer for repairs.

Problem: When the control handle is pushed forward (extend), the splitting wedge does not move.

1. Check the hydraulic tank to make sure the oil level is one inch from the top of the tank.
2. Check the engine-to-pump coupler to make sure the drive keys are in place and there is no damage to the blue urethane spider.
3. Disconnect the splitting wedge from the cylinder. Grasp the hydraulic cylinder shaft and try to pull it out. If the rod comes out easily, you will need to rebuild or replace the cylinder.
4. Once you have determined that the engine-to-pump coupler is intact and the cylinder is in good condition, you will need to replace the pump.

Problem: The engine stalls when the splitting wedge engages the wood.

1. The engine may not be properly adjusted. Take the engine to a service center for repair and/or adjustment.
2. If all engine settings are correct, replace the pump.

Problem: The splitting wedge moves slowly, but will split wood.

1. Check the oil level in the hydraulic tank and fill if necessary.
2. Check the high-pressure hose, fittings, and valve openings for dirt and debris that may have obstructed the openings.
3. If the ram speed is still slow, replace the pump.

Problem: The ram will not automatically retract.

1. Check the slide rail or splitting wedge for damage.
2. Push the valve handle to the retract position. If the handle will not stay in this position, adjust valve detent, as described below.

Detent Adjustment Procedure

- a. Locate adjustment screw on lower side of valve body.
 - b. Loosen locknuts.
 - c. Turn adjustment screw clockwise one-half turn and retighten locknuts.
 - d. Start the engine and test for detent operation. If detent does not work, repeat Steps b and c.
3. If adjustment of detent does not correct the problem, replace the valve assembly.

Problem: Oil squirts from the fill plug during operation.

1. The oil tank may be over-filled. Drain oil to 1 inch below the top of the tank.
2. The log splitter is not level. Make sure the log splitter is on level ground.

⚠ WARNING



Make sure all decals are attached to the log splitter and/or engine and are legible at all times.

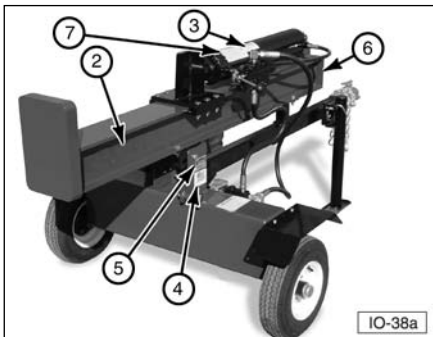
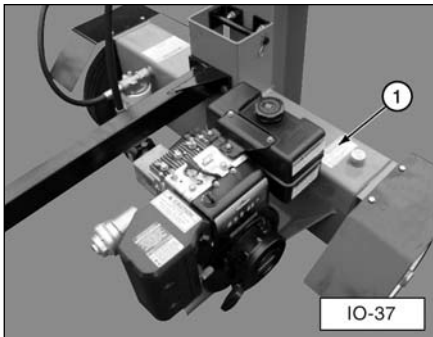

(3)

<h3>Operator Safety</h3> <p style="text-align: center;">Seguridad del operario</p>		
CAUTION / PRECAUCIÓN		
	Read Owner/Operator manual completely. <i>Lea todo el manual del propietario/operario.</i>	
	Operate log splitter on flat, dry ground. <i>La cortadora de troncos debe estar sobre suelo firme y seco.</i>	
	Lock rail into Vertical or Horizontal position before using. <i>(Some Iron & Oak models operate only in Horizontal position.) Trabe el riel en posición Vertical u Horizontal antes de usarlo. (Algunos modelos Iron & Oak sólo usan la posición Horizontal.)</i>	
	NO ONE under age 18 is allowed to operate log splitter. <i>NADIE</i> menor de 18 años está autorizado a utilizar la cortadora de troncos.	
	Keep bystanders, children, and helpers at least 25 ft. away. <i>No permita que observadores, niños y ayudantes se acerquen más de 25 pies/7.6m.</i>	
	Wear safety glasses, tight fitting work gloves, and safety shoes. <i>Use lentes de seguridad, guantes de trabajo ajustados y zapatos de seguridad.</i>	
WARNING / ADVERTENCIA		
	Keep hands and all body parts away from splitting wedge, base plate, partially split wood, and moving parts. <i>Aleje las manos y el cuerpo de la cuña cortadora, la base de apoyo, la madera cortada parcialmente y las piezas móviles.</i>	
	Hold logs by the sides, not the ends. <i>Tome los troncos por los lados, no por los extremos.</i>	
	Only one person is permitted to stabilize logs and operate the controls. <i>Sólo una persona debe estabilizar los troncos y operar los controles.</i>	
	Do not check for oil leaks with your hand. Use a cloth. High pressure hydraulic fluid can penetrate your skin, causing blood poisoning. <i>No utilice la mano para ver si hay pérdidas de aceite. Use un paño. El fluido hidráulico con alta presión puede penetrar la piel y provocar envenenamiento.</i>	
	Never operate log splitter under the influence of alcohol or drugs. <i>Nunca opere la cortadora de troncos si ha bebido o tomado drogas.</i>	
OPERATING INSTRUCTIONS / INSTRUCCIONES OPERATIVAS		
1.	Read Owner/Operator manual for complete instructions. <i>Lea el manual del propietario/operario para ver todas las instrucciones.</i>	
2.	Start engine using instructions from engine manual. Advance throttle control to maximum speed. <i>Ponga en marcha la máquina según el manual del motor. Lleve el regulador a la velocidad máxima.</i>	
3.	Grab log by sides and place onto rail, against base plate. <i>Tome el tronco por los lados y colóquelo sobre el riel, contra la base de apoyo.</i>	
4.	If necessary, stabilize log by holding the side, never the end. <i>Si es necesario, estabilice el tronco tomándolo de un costado, no del extremo.</i>	
5.	Move control handle to FORWARD position to extend splitting wedge. <i>Coloque la manivela de control en ADELANTE para alargar la cuña cortadora.</i>	
6.	Release handle to STOP splitting wedge. <i>Libere la manivela para DETENER la cuña.</i>	
7.	Move control handle to REVERSE position to retract splitting wedge. <i>Coloque la manivela de control en REVERSO para retraer la cuña cortadora.</i>	
CONTROL VALVE / Valvula de control		
Reverse	▲	Reverso
Neutral	●	Neutro
Forward	▼	Adelante

(1)



(6)



(4)

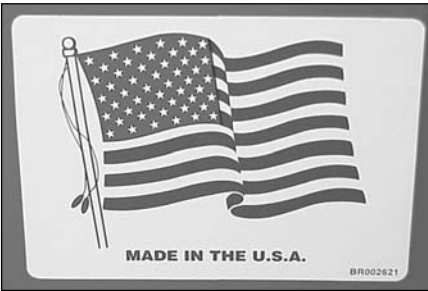

(7)

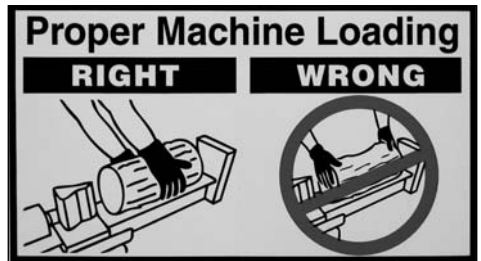

(5)



Item	Part No.	Description	Qty.
1	BR002652	Decal, Notice	1
2 (NS)	BR002627	Decal, Iron & Oak (2202)	2
	BR002631	Decal, Iron & Oak (2202FC)	
	BR002628	Decal, Iron & Oak (2602)	
3	BR002302	Decal, Operator Safety	1
4	BR002621	Decal, Flag	1
5	BR002521	Decal, Serial Number	1
6	BR002653	Decal, Maximum Speed	1
7	BR002559	Decal, Proper Machine Loading	1

NS - not shown

Parts

Item	Part No.	Description	Qty	Item	Part No.	Description	Qty
1	BR021249-09	Weldment, Base Tank	1	25	BR021396	Pin, Plunger	1
2	BR001209	Bolt, 5/16-18 x 3/4" long	4	26	BR008151	Spring	1
3	BR007016	Fender	2	27	BR001090	Pin, Slotted Spring, 3/16" dia.	1
4	BR001325	Locknut, 5/16-18	4	28	BR008152	Knob, Bar	1
5	BR008301B	Seal, Inside	2	29	BR031102	Bracket, Hinge	1
6	BR008301A	Bearing, Tapered Roller	4	30	BR001304	Nut, 1/2-13	2
7	BR008317	Hub, Studded	2	31	BR001404	Lockwasher, 1/2"	2
8	BR008303	Tire, 4.8" x 8"	2	32	BR001208	Bolt, 1/2-13 x 1-1/2" long	2
9	BR008301D	Washer, Thrust	2	33	BR021394-09	Weldment, Tongue	1
10	BR008301F	Key, Cotter, 1/8"	2	34	BR020284-02	Weldment, Front Leg	1
11	BR008301G	Dust Cap	2	35	BR008540	Coupler, Hitch, 2"	1
12	BR008301E	Nut, Spindle	2	36	BR008508	Chain Assembly	2
13	BR008317A	Nut, Lug	8	37	BR001201	Bolt, 1/2-13 x 3-1/2" long	4
14	BR001212	Bolt, 5/16-18 x 1-3/4" long	4	38	BR008511	Safety Quick-Link	1
15	BR001401	Washer, 5/16"	6	39	BR001321	Locknut, 1/2"	4
16	BR001402	Lockwasher, 5/16"	4	40	BR001023	Plug Cap	1
17	BR001303	Nut, 5/16-18	4	41	BR008587	Retaining Clip	1
18	BR001021	Plug, Vented Fill	1	42	BR008589	Jack Leg Plunger Kit	1
19	BR001025	O-ring, Vented Fill Plug	1				
23	BR021251	Pin, Hinge	1				
24	BR001764	Clip, Hairpin, 3/32 x 2-1/2" long	1				

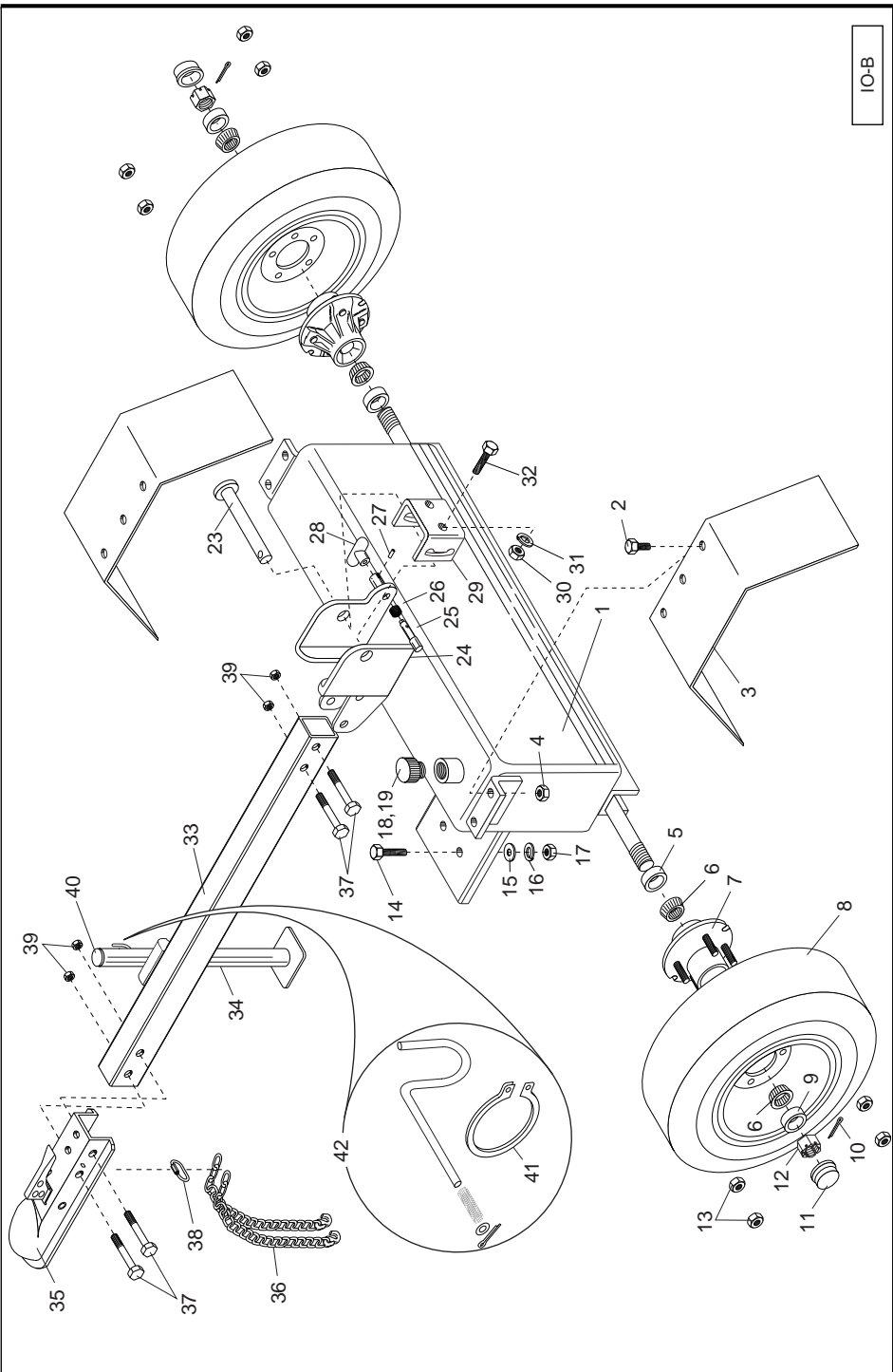

Parts

Standard Rail

Note 1: Hole is used to attach optional BR021180 Log Cradle.

Note 2: Hole is **not** used in this application.

Note 3: Hole is used to attach optional BR021180 Log Cradle and to attach rail weldment to base unit.

Item	Part No.	Description	Qty
1	BR021264-08	Weldment, Rail	1
2	BR001208	Bolt, 1/2-13 x 1-1/2" long	2
3	BR021393-02	Weldment, Rail Rest	1
4	BR001404	Lockwasher, 1/2"	8
5	BR001304	Nut, /2-13	8
6	BR021396	Pin, Plunger	1
7	BR008151	Spring	1
8	BR001090	Pin, Slotted Spring, 3/16" dia.	1
9	BR008152	Knob, Bar	1
10	BR013104	Retainer, Slide	2
11	BR013103	Guide, Slide	2
12	BR001259	Bolt, Carriage, 1/2-13 x 2-1/2"	6
13	BR021163	Weldment, Slide Wedge	1
14	BR001765	Pin, Clevis, 1/2 x 3" long	1
15	BR001761	Clip, Hairpin 3/32 x 1-5/8" long	1
16	BR004057	Cylinder (BHVH2202)	1
	BR004063	Cylinder (BHVH2202FC)	
	BR004056	Cylinder (BHVH2602)	
17	BR008531A	Pin, Grooved, 1" dia.	1
18	BR001705	Clip, Hairpin (Cylinder)	2

IO-A

Standard Rail

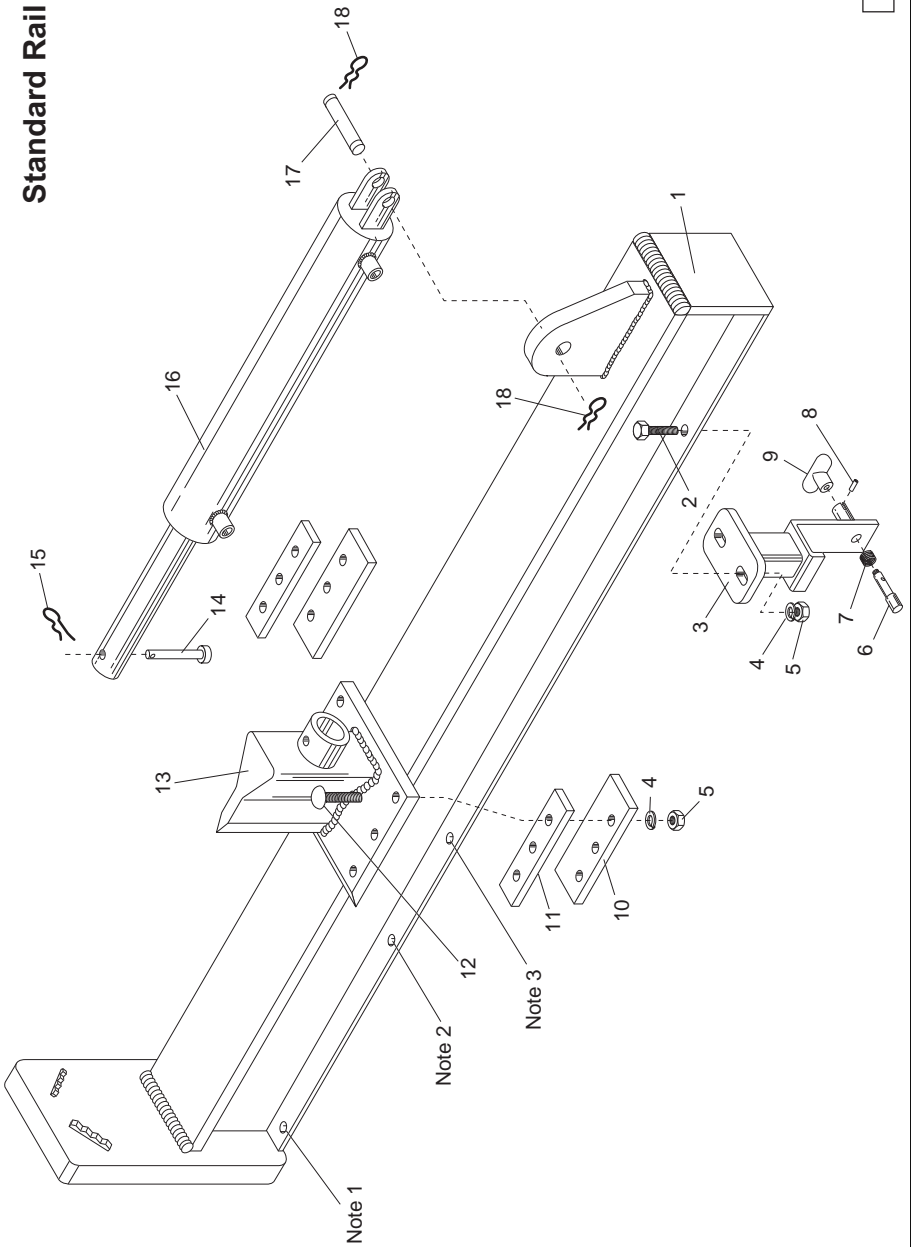

Parts

DURO-GLIDE Rail

Item	Part No.	Description	Qty
1	BR032000	Weldment, Rail	1
2	BR001208	Bolt, 1/2-13 x 1-1/2" long	2
3	BR021393-02	Weldment, Rail Rest	1
4	BR001404	Lockwasher, 1/2"	2
5	BR001304	Nut, 1/2-13	2
6	BR021396	Pin, Plunger	1
7	BR008151	Spring	1
8	BR008152	Knob, Bar	1
9	BR001090	Pin, Slotted Spring, 3/16"	1
10	BR032001	Weldment, Slide Wedge	1
11	BR001216	Bolt, Flat Head, 1/2-13 x 2.5" long	6
12	BR032007	Retainer, Slide Side	2
13	BR032009	Wear Pad, Large	4
14	BR032006	Plate, Slide Guide	2
15	BR032008	Wear Pad, Small	8
16	BR001404	Lockwasher, 1/2"	6
17	BR001304	Nut, 1/2-13	6
18	BR001765	Pin, Clevis, 1/2 x 3" long	1
19	BR001761	Clip, Hairpin, 3/32 x 1-5/8" long	1

Item	Part No.	Description	Qty
20	BR004057 BR004063 BR004056	Cylinder (BHVH2202) Cylinder (BHVH2202FC) Cylinder (BHVH2602)	1
21	BR008531A	Pin, Grooved, 1" diameter	1
22	BR001705	Clip, Hairpin (Cylinder)	2

IO26DG-A

DURO-GLIDE Rail

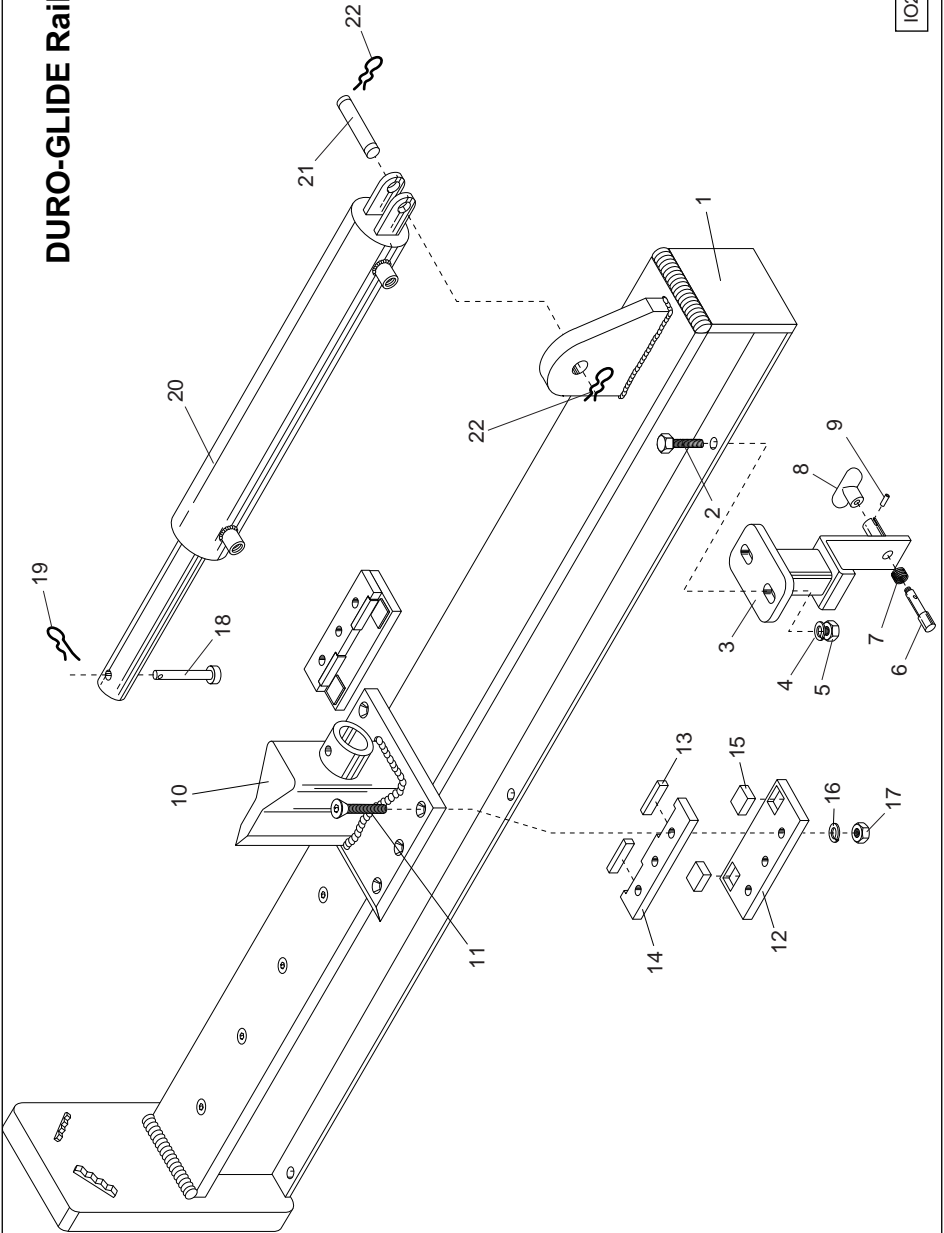

Parts

Item	Part No.	Description	Qty	Item	Part No.	Description	Qty
1	—	Engine (refer to engine manual)	1	12	BR001266	Bolt, 5/16-24 x 3/4" long	4
2	BR010104	Key, 3/16 x 1" (2202)	1		BR001273	Bolt, 5/16-24 x 5 1/2" long (2202)	2
	BR010105	Key, 1/4 x 1" (2202FC, 2602)			BR001275	Bolt, 5/16-24 x 6" long (2202FC, 2602)	2
3	BR001383	Screw, Set, 1/4-20 (2202)	2	13	BR001112	Casting, Head Filter	1
	BR001382	Screw, Set, 5/16-18 (2202FC, 2602)		14	BR001113	Element, Filter	1
4	BR006002C	Coupling, Engine (2202)	1	15	BR005036	Hose, High-Pressure	1
	BR006001C	Coupling, Engine (2202FC, 2602)		16	BR004153	Pin, Clevis, 1/4 x 1" long	2
5	BR006002B	Spider (2202)	1	17	BR004152	Valve Link	1
	BR006001B	Spider (2202FC, 2602)		18	BR004154	Pin, Clevis, 1/4 x 3/4" long	1
6	BR006002D	Coupling, Pump (2202)	1	19	BR004102K	Knob	1
	BR006001D	Coupling, Pump (2202FC, 2602)		20	BR004102B	Handle, Valve	1
7	BR020010	Small Flange, Engine (2202)	1	21	BR004215	Pin, Cotter, 3/32 x 1/2" long	3
	BR020110	Large Flange, Engine (2202FC, 2602)		22	BR005061	Hose, High-Pressure	1
8	BR001402	Lockwasher (Barnes pump)	4	23	BR005080	Hose, Low-Pressure 1 x 9"	1
		Lockwasher (MITE pump)	2	24	BR004999	Clamp, Hose, No. 16	2
9	BR001266	Bolt, 5/16-24 x 3/4" lg. (2202)	4	25	BR001017	Fitting, High-Pressure, 90°	1
	BR001265	Bolt, 5/16-24 x 1" long (2202FC, 2602)		26	BR001052	Fitting, Straight	1
10	BR002001BK	Key (2202)	1	27	BR004002K	Fitting, 90° Elbow	1
	BR002002BK	Key (2202FC, 2602)		28	BR004102	Valve	1
	BR002002MK	Key (2202, 2202FC, 2602)		29	BR001241	End Cap	1
11	BR002001H	Pump, Hydraulic (2202)	1	30	BR004119N	Hose, High-Pressure	1
	BR002002B	Pump, Hydraulic (2202FC, 2602)					
	BR002001M	Pump, Hydraulic (2202)					
	BR002002M	Pump, Hydraulic (2202FC, 2602)					

IO-C

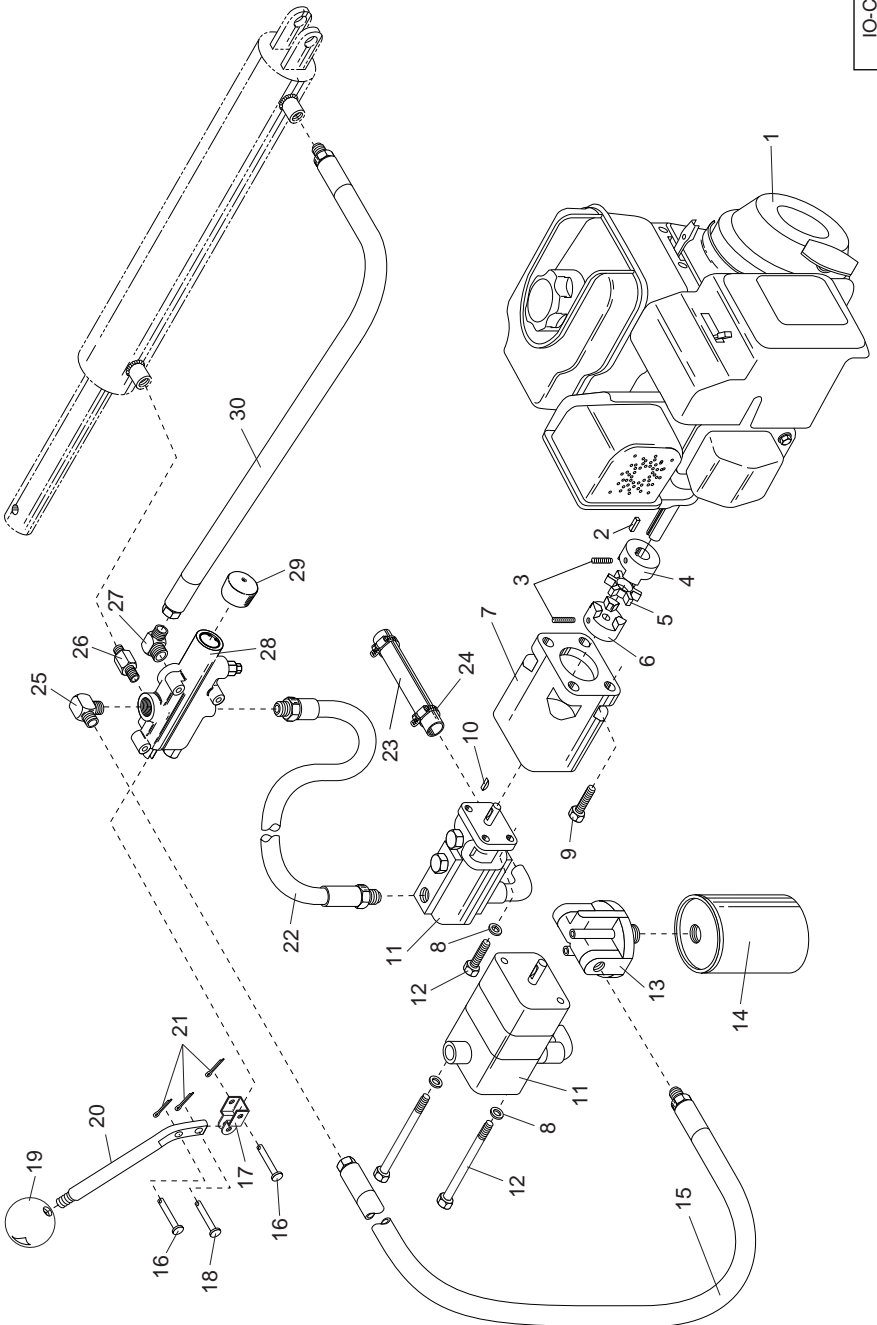

Warranty

For one year from the date of purchase, Iron & Oak Commercial Products, Inc. will replace for the original purchaser, or repair free of charge, all parts of the Iron & Oak Commercial Products hydraulic log splitter, returned to our factory PREPAID and found upon inspection by us to be faulty, due to defects in materials or workmanship.

The warranty shall not apply to any unit which has been overloaded or misused or which has been installed, used, or operated contrary to our instructions, or which has been repaired or altered by anyone other than our authorized representative.

We shall not be liable for any contingent liabilities arising out of the improper function of any parts.

We make NO WARRANTY with respect to parts NOT of our manufacture, but we will carry out the terms of the warranties of their respective manufacturers.

If a service representative cannot be found in your area, call Iron & Oak Commercial Products at (815) 672-8596. Have your model and serial number on hand before calling.

Important Warranty Information

To activate your Iron & Oak log splitter warranty, please fill out the information in the form below, clip out the form on the dotted line, insert into an envelope, and mail to:

Iron & Oak Commercial Products, Inc
P.O. Box 577, Streator, IL 61364-0577

Iron & Oak Log Splitter Warranty Information

- Please Print -

Model: **BHVB2209**, **BHVB2209FC**, or **BHVB2609** SERIAL #: _____
 With DURO-GLIDE Feature

OWNER'S NAME: _____ Phone (____) _____ - _____

ADDRESS: _____

CITY: _____ STATE: _____ ZIP: _____

Purchased From: _____

Street Address: _____

City: _____ State: _____ Zip: _____

Your Signature: _____ Date: _____

Log Cradle (Part No. BR021180)

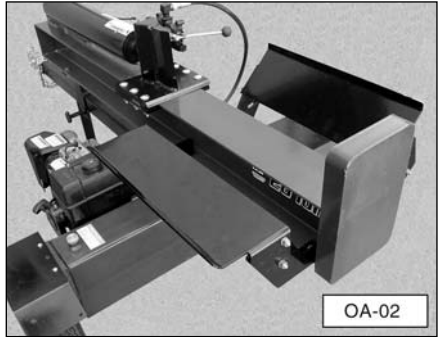
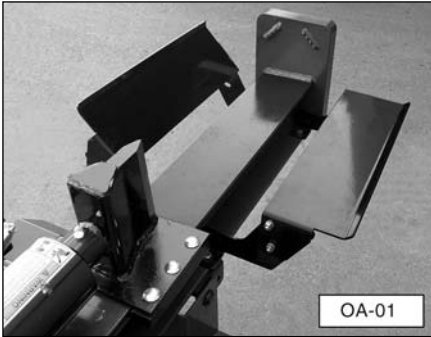

- ✓ Holds log in place on top of rail for faster splitting.
- ✓ Catches split logs - no more stooping to pick up the split pieces.
- ✓ Each shelf is infinitely adjustable up to 45 degrees to accommodate various sizes of logs.
- ✓ Mounts easily to rail - all hardware included, requires no drilling or welding on current model log splitters.

Log Dislodger (Part No. BR021172)

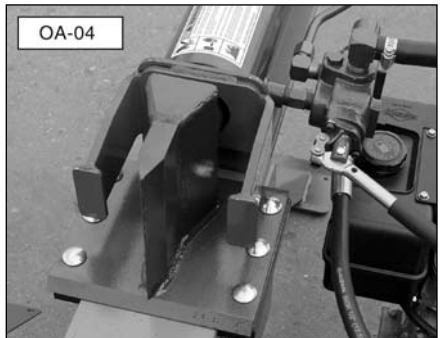
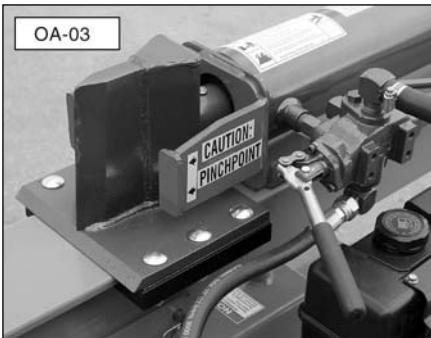

- ✓ Helps eject any log that sticks to the slide wedge.
- ✓ Protects control valve and other hydraulic components from damage.
- ✓ Rugged construction to last the life of your log splitter.
- ✓ Mounts easily to splitter rail - all hardware included, no drilling or welding required.

Optional Attachments

Safety Flag Kit (Part No. BR012104)



- ✓ Improves visibility of log splitter when backing up or towing.
- ✓ Heavy-duty tapered fiberglass pole won't bend over at towing speeds.
- ✓ Installs in minutes, no drilling required.
- ✓ Mounting instructions included.



**COMMERCIAL
PRODUCTS™**

**Iron & Oak Commercial Products, Inc.
410 W. Broadway Ave.
Streator, Illinois 61364-0577
Phone: 815-672-8596
Fax: 815-672-9073
E-mail: sales@logsplitters-ironoak.com
Web Site: www.logsplitters-ironoak.com**

BHVH2209/2209FC/2609-01

12/08