



OPERATOR'S MANUAL

SE Series Belt Driven Rotary Screw Compressors

SE5

SE7.5

SE10

SE15



WARNING

**Personal injury and/or equipment damage will result by failing to pay attention to the vital safety information and instructions in this manual.
Carefully read, understand, and retain all safety information and instructions before operating this compressor.**

Curtis-Toledo, Inc.

1905 Kienlen Ave. St. Louis, MO 63133

phone: 314/383-1300 fax: 314/381-1439 Email: info@curtistoledo.com

WWW.FSCURTIS.COM



WARNING

WHEN DISCONNECTING POWER FROM THE UNIT, POWER MUST BE OFF FOR A MINIMUM OF 15 SECONDS OR AN ERROR CODE MAY BE DISPLAYED ON THE CONTROLLER.

TO CLEAR AN ERROR CODE, REFERENCE CONTROLLER MANUAL

Table of Contents

Contents

1.0 Introduction	
- Preface	1-1
- Safety	1-5
2.0 Receiving and Installation	
- Installation / Precaution	2-1
-Electrical	2-2
3.0 Principle of Screw air compressor	
- General	3-1
- Air/Oil.....	3-2
4.0 System Flow Chart and Components Function	
- System Flow Chart	4-1
- Description	4-2
- SE05 & SE07 Specifications	4-5
- SE10 & SE15 Specifications	4-6
- Protection / Warning	4-7
- Control Systems / Electrical Circuit	4-8
5.0 Operation	
- Inspection	5-1
- Storage	5-2
6.0 Maintenance	
- Maintenance Intervals	6-1
- Air Filter / Oil Filter	6-2
- Air / Oil Separator	6-3
- Lubricant	6-4
- Oil Analysis	6-5
- Thermostatic & Minimum Pressure Valves	6-6
- Belts	6-7
- Sheave.....	6-8
- Fan / Motor	6-9
- Bearings.....	6-10
- Air end / Motor Removal	6-11
- Recommended Maintenance Time Intervals.....	6-12
7.0 Trouble Shooting	
8.0 Maintenance Log	

Supplements:

CAP861: Controller Manual

CAP866: (SE5-SE7.5) Parts List

or

CAP867: (SE10-SE15) Parts List

Operations and Maintenance Manual





Preface

Warning

Read the manual before assembly and operation. Become familiar with this information, its safety instructions and its operation before beginning any work. Serious personal injury may result from safety or operational information is not understood or familiarized.



© **Alert signals**

Description of signals

 Danger	Danger is used to indicate presence of a hazard that will cause severe personal injury or death, or substantial property damage.
 Warning	Warning is used to indicate the presence of a hazard, which can cause severe personal injury, or substantial property damage.
 Caution	Caution is used to indicate the presence of a hazard, which can cause personal injury, or property damage.
 Reference	Supplementary instruction for operation and maintenance

Operations and Maintenance Manual

Illustration of symbols

Symbols	Description of symbols
	Prohibited
	Extreme caution

⊙ **Warning Labels are placed on the machines.**

If the labels are not clear or missing, please contact CURTIS directly.



⊙ **Explanations of safety symbols**

<p>Operation manual</p> <div style="border: 1px solid black; padding: 5px; margin: 10px 0;"> <p style="text-align: center;">CAUTION</p> <p>READ AND UNDERSTAND THE INSTRUCTION MANUAL BEFORE INSTALLING AND OPERATING THIS UNIT. FAILURE TO FOLLOW THE OPERATION AND MAINTENANCE PROCEDURES COULD RESULT IN SEVERE INJURY OR DAMAGE. ONLY QUALIFIED PERSONNEL SHOULD OPERATE OR MAINTAIN THIS ROTARY SCREW COMPRESSOR.</p> <p style="text-align: right; font-size: small;">QAB545</p> </div>	<p>Follow the instructions before use of this compressor. Confirm the direction of rotation before startup.</p>
<p>Caution before startup</p>	<p>To restart compressor after a long period of being inactive, rotate air end manually with the power off. If it is difficult to rotate, please contact CURTIS directly.</p>

Operations and Maintenance Manual

	<p>Danger: Electric circuits</p>
	<p>Danger: Rotating parts</p>
	<p>Danger: Hot or noxious gases outlet: unbreathable</p>
	<p>Danger: Heat. Do not touch hot areas</p>
	<p>Rotation</p>

Operations and Maintenance Manual

	Read instruction
	Hearing protection

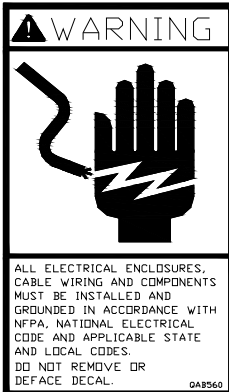
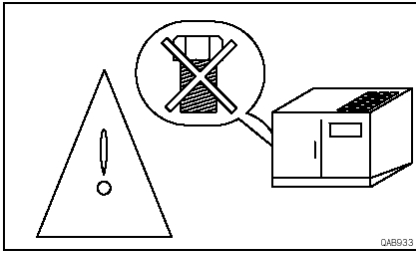
	Turn off power supply before maintenance or operating around electric equipment, such as starter, and motor.
	Remove the 4 bolts that secure the air end/motor sub frame to the enclosure before test run or startup. DO NOT loosen the bolts that go through the isolators. Please contact CURTIS or distributor for assistance if necessary.

Operations and Maintenance Manual

※ Please do not tear off label stickers from the machine

Safety

1. Become familiar with this manual and follow the instructions before operating the compressor.
2. If any malfunctions or trouble occurs, do not run compressor until problem is resolved.
3. Make sure the compressor has been disconnected before servicing or changing parts. Lockout and tag out prior to maintenance.
4. To ensure human safety and protect the facility from damage, do NOT ignore electrical grounding.
5. Wear proper apparel during operation. Protective clothing should be worn such as facemask or safety goggles and non slip footwear.

Operations and Maintenance Manual

Additional Safety information for Air Compressors

Like all power tools, there is danger associated with operating this equipment. Accidents are frequently caused by lack of familiarity or failure to pay attention. Use this machine with extreme caution. If normal safety precautions are overlooked or ignored, serious personal injury may occur.

The following are some safety suggestions that users should notice:

Caution

- Users who neglect these safety precautions may result in serious injury or death.
- Fingers and clothing have to stay far away from rotating parts.
- Compressed air from this machine cannot be used for pharmaceutical, food or health requirements without further treatment.
- Release all pressure from the system prior to maintenance.
- Electric shock could be fatal.
- Grounding of starter and motor is necessary. Choose grounding cable according to the power range of the compressor.
- Ground fan motor through starter.
- Lockout and tag out power supply before working on control panel.
- Lockout and tag out power supply before inspection and maintenance —compressor is controlled by PID and may start automatically according to the setting.

Warning

Users who neglect the following instructions might damage the compressor.

- Lockout and tag out the compressor if maintenance is needed.
- Lockout and tag out power supply before inspection and maintenance —compressor is controlled by PID and may start automatically according to the setting.
- Relief valve is necessary for air piping larger than 1/2”.
- Do not exceed the rated discharge pressure on nameplate during operation.
- The enclosure should be in place prior to operation

Operations and Maintenance Manual

Chapter 2 Receiving and Installation

A. Receiving

1. Please check if you received the correct shipment as you ordered.
2. Please check if the machine and any accessories received any damage during the shipment.

B. Installation.

In order to ensure proper installation and trouble free operation with minimal maintenance:

1. Select a location where light is adequate enough to operate, maintain, and inspect the compressor.
2. A clean, low relative humidity and well-ventilated area is best for safe operation. The ambient temperature should be kept below 104°F (40°C). The air delivery of the compressor will decrease as the temperature gets higher.
3. Reserve space for maintenance, the distance between the compressor and the wall or other facilities must be greater than 28 inches (71 cm).
4. Must be at least 3 feet of clearance between top of compressor and over head obstructions.

Figure: 2-1

Model	Heating (BTU) / HR	Volume of Ventilating Fan (CFM)	Ventilating Volume of Compressor Room (CFM)
SE5	15476	1483	>1518
SE7.5	23214	1483	>2260
SE10	30754	1978	>3000
SE15	46230	1978	>4520

Remarks: Above data of compressor room temperature rise according to design by atmospheric temperature add 41°F (5 °C).

C. Precaution for piping foundation and cooling system

1. Air piping

- (1). Install required accessories.
- (2). Main piping should have 1° - 2° slope away from compressor to drain the condensate.
- (3). Pressure drop of piping must not exceed 5% of discharge pressure. Select larger pipeline than required for better efficiency.
- (4). Branch line must be located at the top side of main pipeline to avoid the condensate from flowing to the facilities.
- (5). To prolong service life of pneumatic tools, install an air filter regulator unit on the outlet.
- (6). Do not randomly reduce the size of main pipeline. Use the proper reducer if it is necessary, otherwise a great pressure loss will be caused.
- (7). The ideal installation arrangement of air solution is air compressor + air tank + dryer. Air tank is capable of draining some of the condensate and cooling down the temperature of compressed air. This will lead to the dryer operating more efficiently.
- (8). If the air requirement is large in a short period, install a higher volume air tank to reduce the frequency of full/off load control.
- (9). The ideal main pipeline constructed around the factory as a loop is better for delivering compressed air from both sides at any point.

Operations and Maintenance Manual

2. Foundation

- (1). Select a solid and level surface foundation to install the compressor.
- (2). There is no need to construct a base for screw air compressor since the vibration of it is relatively small. However the site of placement must be flat and strong enough to support the weight of the unit.

3. Cooling system

Install an air-cooled compressor in a well-ventilated area to avoid high temperature shutdown. If it is in a sealed room, air extracting and removal apparatus is required and its capacity must be larger than cooling fan's in compressor. In accordance with (Figure: 2-1) please select proper ventilating equipment for use.

Electrical

A qualified electrician in compliance with standards and local codes should do all electrical wiring. Be sure to investigate the local requirements before installing the compressor. Refer to the wiring diagram before starting any work.

The power supply should be adequate and free of parasitic loads that will cause an under voltage condition during the operation of the compressor, otherwise there will be nuisance electrical shutdowns. This equipment requires a properly grounded electrical disconnect switch.

We recommend the use of time delay fuses in a fusible disconnect for isolating the unit. This disconnect should be located so an operator can disconnect the unit without nearing the unit, in case of an emergency. We also recommend the use of a lockout/tagout to help insure safety during maintenance of the compressor. Per the National Electric Code the time delay fuses should be sized at 175% of the full load amperage (FLA) found on the motor nameplate. Consult the Code if you want to use another style of branch circuit protection.

Operations and Maintenance Manual

Electrical (cont.)



WARNING

Failure to properly ground compressor package could result in controller malfunction.

All internal wiring has been done at the factory. Wiring of the power supply to the compressor should be done by a qualified electrician to comply with the National Electric Code, state code, and any local codes in accordance with the wiring diagram specific to your compressor model shown in the included wire diagram.

Chart of Unit Amp Draw

Figure: 2-2

Model		200 V	230 V	460 V	575V	230V-1Ø
SE5	Amp Draw	23.7	20.3	10.2	9.5	30.6
SE7.5	Amp Draw	33.3	28.8	14.4	11.7	43.5
SE10	Amp Draw	42.8	37	18.5	14.5	
SE15	Amp Draw	62.9	54.5	27.3	21.9	

Operations and Maintenance Manual

Chapter 3 General Description

COMPRESSOR

The compressor assembly is an oil flooded positive displacement, single stage, helical screw type unit consisting of two rotors or screws supported axially by roller bearings and enclosed in a housing or stator as depicted in the sectional view Figure 3-1.

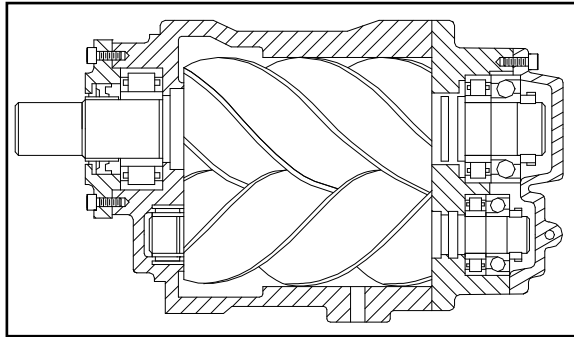

Figure 3-1
Compressor Assembly

In operation as depicted below in the compression cycle (Ref. Figure 2-2), air entering the compressor through the inlet port becomes trapped between the helical lobes of the main rotor and the matching grooves of the secondary rotor (A). As the rotors turn air is trapped in the cavity created by the mashing lobe and groove and reduced in volume or “compressed”. It is then pushed through the successive cavities (B) until it reaches the discharge end of the compressor (C) and is sent to the oil separator.

During the compressor cycle, oil is injected into the compressor for the purpose of dissipating the heat of compression and to seal the internal clearances. The compressed air laden with oil leaves the compressor through the discharge port and enters a reservoir where the oil and air are separated. This process delivers a smooth flow of compressed air at the desired pressure.

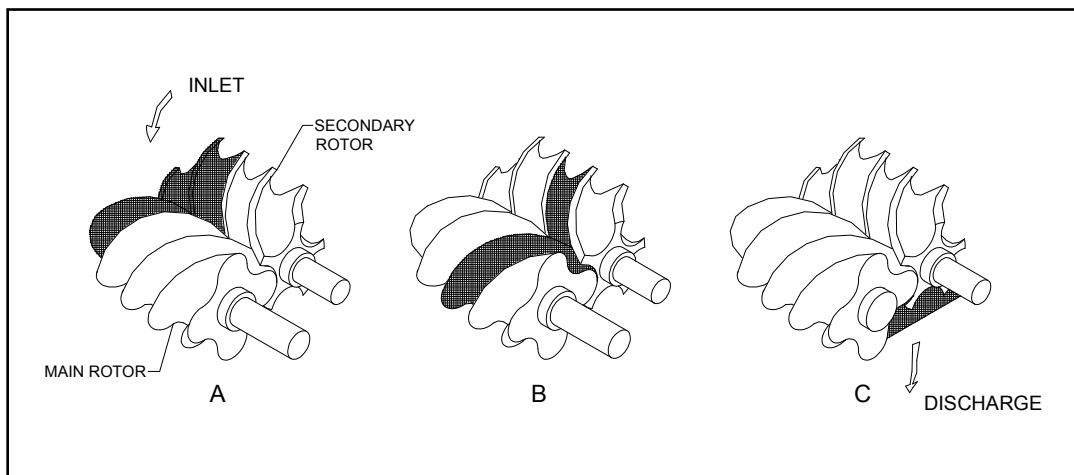

Figure 2-2
Compression Cycle

Operations and Maintenance Manual

AIR/OIL FLOW

Air enters the compressor through the air filter and air inlet valve where it is mixed with oil. After compression the air/oil mixture is discharged into the oil separator where its velocity is reduced causing most of the oil to drop to the bottom. The remaining oil is removed as the air passes through the separator element. Oil collected at the bottom of the separator element is returned to the inlet of the compressor through the scavenger line that is equipped with a sight glass for monitoring the flow of oil to determine when separator replacement is necessary. The coalesced air then passes through the minimum pressure valve set to maintain a minimum of 65 PSI in the oil separator to ensure a sufficient flow of oil to the compressor. The compressed air then enters the aftercooler where it is cooled and discharged to its point of usage.

A sufficient amount of oil is stored in the oil separator tank and is forced by the pressure of compression from the separator to the thermal by-pass valve, which regulates its flow into the oil cooler depending on the temperature of the oil. The thermal valve will open when the oil reaches a predetermined temperature allowing the hot oil to enter the cooler. Oil, which has not reached this temperature setting, will by-pass the cooler.

The oil is then filtered and sent to the compressor to initiate the compression cycle. The oil also serves as lubrication for the compressor bearings.

Curtis-Toledo Rotary Compressor

Operations and Maintenance Manual

CAP863

Chapter 4 System flow diagram and components function

A. System flow diagram and components function

B. SE5-15 System Flow Diagram

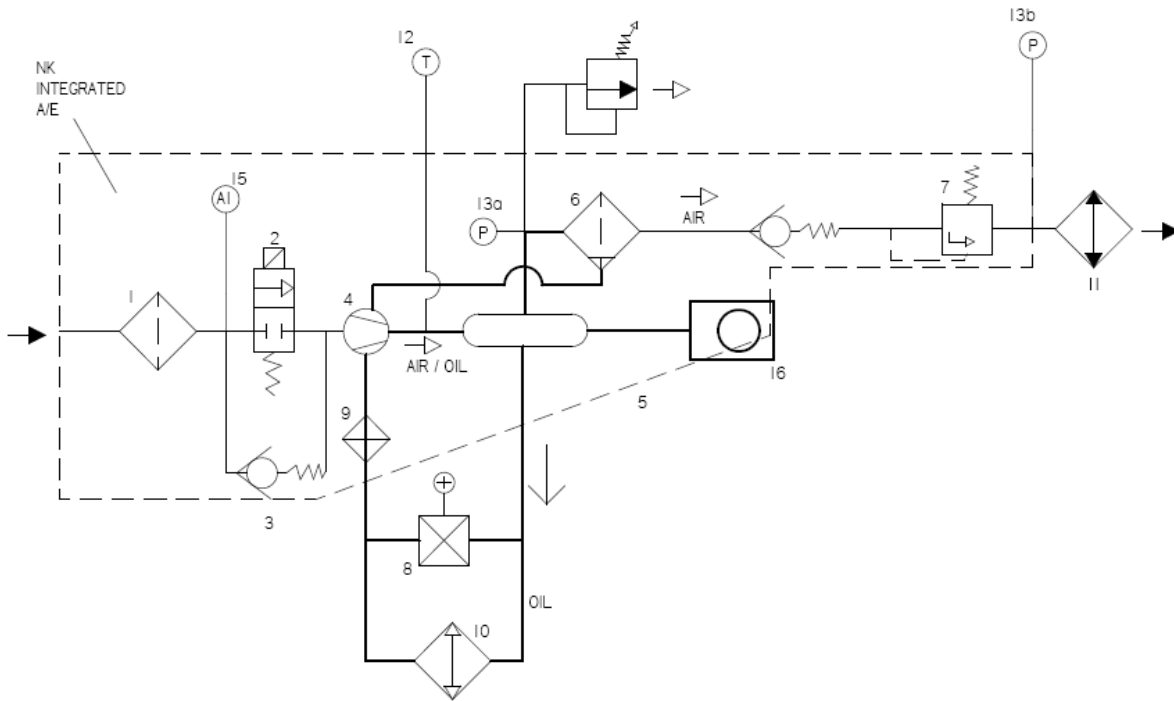

1	Intake Filter	10	Oil Cooler
2	Solenoid Valve	11	Air Aftercooler
3	Check Valve	12	Temperature Sensor
4	Screw Compressor	13a	Pressure Sensor-System
5	Separator Receiver	13b	Pressure Sensor-Network
6	Air/Oil Separator	14	Safety Valve
7	Minimum Pressure Valve	15	Air Filter Indicator
8	Thermostatic Control Valve	16	Sight Glass
9	Oil Filter		

Operations and Maintenance Manual

B. Description of system flow chart and component function

1. Air flow path (refer to the flow chart of each type)

1.1. After dust is removed by intake filter, clean air goes through the intake valve into the compression chamber and is mixed with oil. The mixture is compressed and delivered through the oil separator, minimum pressure valve, after cooler, and moisture separator.

1.2. Function of parts in the air flow path

(1). Air intake filter

Air intake filter is a suction filter which is a special-purpose air cleaner of the air compressor. For normal environmental use, clean the dust on the element from inside out with compressed air every 1,000 hours of operation. The air filter LED lamp “on” implies that the filter needs to be cleaned or replaced.

(2). Intake Valve

On/Off Load Control : for SE5/SE7.5/SE10/SE15 models

The solenoid valve is switched by different capacity controls such as: startup, stop, off load. Each will move the piston of the intake valve. In the mean time, the shuttle valve keeps minimum pressure to maintain oil circulation.

When system pressure is less than the unload setting value, the solenoid valve is activated, thus the intake valve is now fully opened. On the other hand, when the value is reached, the intake valve is closed and the compressor is running off load.

(3). Thermal couple

Lack of oil in circulation will induce high discharge temperature. It will be shown on the panel through the signal from the thermal couple. General setting value is 230°F (110°C). Do not operate over this temperature otherwise compressor trip will occur.

(4). Separator (tank)

There is an oil gauge on the bottom side of tank. Maintain the oil level between H-L. On the bottom there is a drain valve, remember to drain condensate water every time before startup. In addition, an oil fill hole for oil replacement is on the tank as well. The larger cross-section area design of this tank will slow down the compressed air, this is known as the first stage of air oil separation.

(5). Oil separator

Please refer to the description on oil flow path.

(6). Relief Solenoid Valve

Upon start, stop, or off load running, this valve will release pressure to ensure air end starts without back pressure or stops under off load running.

(7). Minimum Pressure Valve

Minimum pressure valve is located at the outlet of air discharge from separator tank. Operating pressure is set to be around 65 PSIG (4.5 kg/cm²). The functions of minimum pressure valve are shown below:

A. To build up oil circulation pressure and operating temperature at start-up.

B. When pressure is over 65 PSIG (4.5 kg/cm²), it will reduce flow rate passing and protect oil separator from damage due to large pressure difference and increase oil separator efficiency.

C. Prevent back flow under off load running.

Operations and Maintenance Manual

(8). After Cooler

This is the cooler for air-cooled series compressors. The compressed air is being cooled by fan blowing air through the radiator. Generally discharge air temperature is 10-15°F above ambient temperature. **Environment is a crucial factor for air-cooled type air compressors; please install in a well-ventilated area.**

(9). Moisture Separator

It is a cyclone type separator. It will drain condensate, water, oil drop, and particles from cooled air.

(10). Auto Drain Valve

Collects and drains out condensate water automatically from water separator.

2. Oil flow path (refer to the flow chart of each type)

(1). Description of oil injected flow chart

Pressure in the separator pushes oil into oil cooler and then passes through the oil filter for filtration after being cooled down. Oil flow is further separated into 2 directions: one goes into compression chamber from the bottom of air end. The other goes to the bearing on the discharge side for lubrication. Then the compressed air and oil mixture is delivered to the separator tank again to separate most of the oil from the oil separator (1st Stage) while the rest of the oil mist goes through oil separator (2nd Stage) for further separation. Finally passes through minimum pressure valve into after cooler and is discharged.

(2). Volume of oil injection

The purpose of oil injection in an oil flooded screw compressor is to dissipate the heat away in the process of air compression.

(3). Function of parts on the oil flow system

A. Oil Cooler

The function of oil cooler is the same as air cooler. Environment is a crucial factor for air-cooled type compressor; please install unit in a well-ventilated area. Clean the dust on the fins of radiator periodically with compressed air or with solvent.

B. Oil Filter

Oil filters help get rid of metallic particles, sludge ... etc. from compressor oil in order to protect bearings and rotors. Once the first 500 hours of operation is reached, please follow the instructions for replacement. Failure to do so may result in lack of oil which will lead to high discharge temperature and shorter bearing life.

C. Oil Separator

a. Function

The element of the oil separator is made by multiple layers of filtration materials. Most of the oil mist comprised in the compressed air could be filtered out through a separator. The life span of the oil separator is affected greatly by lubricant grade and condition. Use CURTIS R/S 8000 in order to maintain your warranty. There is a pressure relief valve (safety valve) and a minimum pressure valve at the oil separator outlet. Compressed air is led through the oil separator, to the minimum pressure valve, and then to the after cooler. Oil collected by the separator will return to the suction side of the air end to avoid oil carry over.

b. Requirement of oil separator replacement

1. Oil carry-over increases.
2. Warning on the controller indicates replacement is required.
3. Running current increases.

Operations and Maintenance Manual

3. Cooling system

Air-cooled

Air is fed by a fan through the radiator fins and dissipates heat away from the compressed air and oil. The highest allowable unit temperature setting is 230°F (110°C). Any temperature above this will result in compressor shutdown.

Curtis-Toledo Rotary Compressor

CAP863

Operations and Maintenance Manual

SE Series Screw Air Compressor Specification

Model		SE5				SE7.5				
Item	Model									
System	Operating Pressure	psig bar	100 6.8	125 8.6	150 10.3	175 12	100 6.8	125 8.6	150 10.3	175 12
	Capacity	cfm m ³ /min	18 0.5	16 0.5	15 0.4	12 0.3	32 0.9	27 0.8	24 0.7	21 0.6
	Air Discharge Temp.	°F	Ambient temperature +27°							
	Pressure relief valve setting	psig	Setting pressure 200 psig							
Motor	Power	hp kw	5 3.7				7.5 5.5			
	Enclosure	Type	TEFC (IP55)							
	Main Motor Speed	rpm	3495				3535			
	Fan Motor Power	h.p. / kw	.25 / .18				.25 H.P. / .18			
	Starter	Type	FVM							
	Voltage	Volt	200/230/460/575V, 3PH 230V, 1PH							
	Frequency	Hz	60							
Dimension	Length	in (mm)	33 ¾ (857)				33 ¾ (857)			
	Width	in (mm)	24 ½ (622)				24 ½ (622)			
	Height	in (mm)	35 ½ (902)				35 ½ (902)			
	Weight	lb (kg)	549 (249)				572 (260)			
Discharge outlet		inch	½ ” NPT				½ ” NPT			
Oil Capacity		Gal (L)	1 (3.8)				1.5 (5.5)			

Curtis-Toledo Rotary Compressor

CAP863

Operations and Maintenance Manual

Model		SE10				SE15				
Item	Model									
System	Operating Pressure	psig bar	100 6.8	125 8.6	150 10.3	175 12	100 6.8	125 8.6	150 10.3	175 12
	Capacity	cfm m ³ /min	42 1.2	37 1.0	34 1.0	30 0.8	62 1.8	56 1.6	53 1.5	46 1.3
	Air Discharge Temp.	°F	Ambient temperature+27°							
	Pressure relief valve setting	PSIG	200							
Motor	Power	hp kw	10 7.5				15 11			
	Enclosure	Type	TEFC							
	Main Motor Speed	rpm	3535				3560			
	Fan Motor Power	h.p. / kw	.4 / .3				.4 / .3			
	Starter	Type	FVM							
	Voltage	Volt	200/230/460/575V, 3PH							
	Frequency	Hz	60							
Dimension	Length	in (mm)	34 ½ (877)				34 ½ (877)			
	Width	in (mm)	27 ½ (699)				27 ½ (699)			
	Height	in (mm)	43 (1092)				43 (1092)			
	Weight	lb (kg)	667 (303)				836 (379)			
Discharge outlet		inch	¾" NPT				¾" NPT			
Oil Capacity		Gal (L)	1.5 (5.5)				2.1 (8)			

Operations and Maintenance Manual

E Protection and warning

1. Motor overload protection

There are two motors in the compressor assembly. One is the main driving motor and the other is a cooling fan motor. Generally, when running current that exceeds the upper limit of the relay, the main power will shutdown automatically. Re-setting the unit is required prior to the next startup. The relay limit has been preset by the factory. To maintain normal operation, please do not change the limit setting without consulting the factory.

(1) Human error: such as adjusting to higher discharge pressure, or improper setting of the overload relay may cause a nuisance trip.

(2) Mechanical failure:

A. Such as motor internal phase loss, pressure relief valve malfunction improper setting, oil separator clog and startup with back pressure resulting from none closed intake valve...etc...

B. If motor overloads during operation, please contact manufacturer immediately to prevent damage to the motor.

2. Protection for discharge temperature

Discharge temperature setting is 230°F (110°C). If the temperature exceeds 230°F (110°C), the compressor will trip. One of the most common reasons for high discharge temperature is an issue with the oil cooler. For an air-cooled compressor, if the radiator is clogged, oil temperature goes up resulting in compressor to trip because cooling air can't pass through the radiator. Clean the dust off the fins of the radiator periodically with compressed air or with a solvent if the situation gets worse.

Air compressors are designed to operate up to 104°F (40°C) ambient temperature making it necessary to place it in a well-ventilated area. **When the compressor is tripped due to a high discharge temperature, the system is unable to restart unless the reset button is pressed.**

3. Warning

Compressor has a warning system for the air intake filter, oil filter, and oil separator. If one of these filters is clogged, the controller will show a warning. Please replace with factory parts to ensure safety and high efficiency operation.

Operations and Maintenance Manual

F Control system and electric circuit

1. Control system

(1) Motor startup

During the startup period, the intake valve is closed; the relief valve is opened making the suction side in a vacuum. Oil circulates to lubricate the compression chamber and the bearing is protected by the pressure difference between the vacuum and atmosphere.

(2) Motor operation

After the motor startup, the solenoid valve is activated and the relief valve is closed. Pressure gradually increases and the intake valve starts to gradually open, until the compressor runs at full load with the intake valve fully open. Air is then delivered through the minimum pressure valve to the end user when pressure is at least 65 PSIG (4.5kg/cm²G).

(3) Full/off load operation

When the discharge pressure reaches the upper limit of the system, the solenoid valve is cutoff and relief valve is opened resulting in the intake valve being closed. Compressor is then running in off load.

(4) Stop

Pressing the “OFF” button will lead to an opened solenoid valve and a closed intake valve. As a result the air is then discharged into the atmosphere. When pressure in the tank reduces to certain value, motor will then shutdown.

(5) Emergency stop

When the emergency stop is activated, the main power supply will be shutdown with a warning shown on the control panel. Motor will stop immediately with an opened relief valve, and closed intake valve to prevent lubricant from coming out of the air end. **Only use the emergency stop button in a hazardous situation.**

(6) Auto stop for a time lag

If compressed air is not required, the compressor runs on “off load” until it is stopped after a set time lag. If compressed air is required, the compressor runs at “full load” to meet the demand. The amount of possible auto stops is limited to less than twice for each hour. Since there is no warning on the panel for an auto stop, be careful using this function. **Frequent starting and stopping of the motor will result in motor damage.**

Operations and Maintenance Manual

2. Electric Circuit

There are 2 types of electric control in the compressor: one being internal control, the other is starter control.

Our starter uses FVM start control. The compressor system is controlled by an electronic circuit which is complex and will not be noted here. If there are any malfunctions, please refer to control manual.

3. Controller:

Please refer to the controller manual (CAP 861). (User's Controller Guide), included in document package.

Operations and Maintenance Manual

Chapter 5 Operating Procedure

A Test run: startup and shutdown

1. Connect power and grounding cable, and check power supply.
2. Maintain oil level keeping it:
 - Filled up to the air end fill port visible after removing fill cap for the SE5
 - Visible in the window by the oil fill port on the side of the air end for the SE7.5-SE10.
 - Visible in the straw site glass on side of the air end for the SE15.
3. **If the initial run will be after a long period from delivery, add 0.5 quarts of CURTIS RS8000 lubricant through intake valve and rotate air end manually to prevent compressor damage from lack of oil.**
4. Check cooling system
5. A few seconds after startup press the “Emergency Stop” button and identify the direction of rotation. Switch any 2 of the 3 power cables if direction is not correct.
6. Press “ON” to restart the compressor.
7. **Observe any warning from panel and LED lights.**
8. Time relay will be activated after pressing the “OFF” button; the motor will stop automatically after 10-15 seconds.
9. Compressed air will be released immediately after pressing the “OFF” button.

B Inspection before startup

In order to protect the compressor and increase operation efficiency it is necessary to inspect the system prior to operation.

1. **Open the ball valve below the oil tank to drain the water. Condensed water will cause bearing damage and reduce the lifespan of the lubricant.**
2. Check oil level:

Please do not use lubricant other than CURTIS RS8000 for warranty purposes. Make sure the pressure is released before refilling.

Warning: Opening the oil fill cap while pressure is not released may cause injury.
3. Inspect the oil level after 10 minutes of shutdown. The Oil level could read lower during operation.

Operations and Maintenance Manual

C During operation

1. **Shutdown the compressor if abnormal noise or vibration is observed.**
2. Do not loosen any screws or open any control valve during operation.
Warning: Failure to do so may cause injury.
3. Make sure condensed water comes out of the after cooler and water separator. Moisture is not wanted in the system.
4. Record voltage: current, discharge pressure, discharge temperature, oil level and inspect gauges periodically during operation for future reference.

D Storage

In some cases it may be necessary to store the compressor for extended periods of several months before placing the unit in operation. When this is required do the following:

1. Cover and seal all machine openings to prevent the entrance of water and dirt.
2. Cover all openings in open drip proof motors to prevent the entrance of rodents.
3. If the storage conditions are below freezing, drain off the after cooler, traps, water-cooled heat exchangers and attendant piping. It is not recommend for outside storage.

Operations and Maintenance Manual

6.0 Maintenance

6.1 Maintenance Intervals

Daily or Every 8 Hours	<ol style="list-style-type: none"> 1. Check the sump for the correct oil level. 2. Drain condensate from air receiver. (If available) 3. Check the pressure reading to insure proper operating point 4. Check controls for proper operation.
Weekly	<ol style="list-style-type: none"> 1. Inspect the air filter element for clogging or holes. 2. Drain the condensate from the sump. Depending on the humidity this may be necessary daily. Prior to draining the compressor should be shutdown for two hours to allow water and oil to separate. 3. Check the pressure relief valve for operation. This valve is factory set and no attempt should be made to readjust it. 4. Check the machine for oil leaks, loose fasteners, and connections. Also note hose condition and replace if necessary. 5. Clean the cabinet filter. 6. Clean external filters, if applicable. 7. Belts-first check after 50 hrs for proper tensioning.
Initial - 30 days or 500 hours	<ol style="list-style-type: none"> 1. Change oil filter element.
Every 6 months or 1000 hours	<ol style="list-style-type: none"> 1. Inspect air filter element. 2. Check the belts for signs of wear and replace as necessary. 3. Clean motor and ventilation openings. 4. Take oil sample if applicable. * 5. Check hoses for signs of wear or deterioration. **
Every 12 months or 2000 hours	<ol style="list-style-type: none"> 1. Change oil filter element. 2. Change air filter element. 3. Observe overall condition of unit – clean if necessary. 4. Check electrical connections. 5. Observe unit for proper load/unload cycle. 6. Clean oil scavenger line orifice. 7. Regrease the motor bearings.
Every 12 months or 4000 hours	<ol style="list-style-type: none"> 1. Change the air/oil separator. 2. Check V-belt alignment.
Every 12 months or 8000 hours	<ol style="list-style-type: none"> 1. Change the compressor oil. (Synthetic oil – RS8000)

* Oil sample required with extended life warranty program. (synthetic oil only)

** Replace as necessary or every 5 years.

Note: Maintenance schedule should be reduced by half if operating at 200° F or above, or in dirty ambient environment, or with frequent cold starts.

For Oil Life versus Operating Temperature, see chart “Section 6.4”.

Operations and Maintenance Manual

6.2 Air Filter

The air filter is the primary protection of the compressor from harmful dirt being ingested into the oil system. It needs to be looked at weekly for clogging or holes. The period for these inspections is dependent on the environment the machine is in (at least 2000 hours).

Element Inspection and Replacement

1. Switch off the unit, disconnect the power, and lock and tag to prevent accidental starting.
2. Allow one minute after stopping for the system to settle and the pressure to be relieved.
3. Loosen the wingnut that secures the cover, and remove the cover.
4. Loosen the wingnut that secures the element and remove the element.
5. Place a bright light inside the element to inspect for damage or leak holes. Discard any element that shows the slightest hole.
6. Inspect all the gaskets and gasket contact surfaces of the housing. Correct any faulty conditions immediately.
7. Clean the housing with a damp cloth. Do not attempt to blow out dirt with compressed air.
8. Place a new element in the housing and re-secure in place with the wingnut.
9. Replace the cover and tighten the wingnut.
10. Reset the filter service advisory in the controller and the machine will be ready for operation.

6.3 Oil Filter

The oil filter in the compressor system is a full flow replaceable canister type. Initially the filter should be replaced after 500 hours of operation, then every 2000 hours. This element protects the compressor bearings from grit and dirt ingestion throughout the system. A dirty filter will cause an oil flow restriction that can result in high oil temperature and a unit shutdown.

DANGER

Hot oil under pressure will cause severe injury, death, or property damage.

Be sure the compressor is shutdown and pressure relieved before attempting to remove the oil filter, separator, oil fill, or change the oil.

Oil Filter Replacement

1. Switch off the unit, disconnect the power, and lockout and tag to prevent accidental starting.
2. Allow one minute after stopping for the system to settle and the pressure to be relieved.
3. Using a strap wrench, remove the old element and gasket.
4. Clean the gasket surface with a clean rag.
5. Apply a light film of oil to the new gasket.
6. Hand tighten the new element until the new gasket is seated in the gasket groove.
7. Continue tightening by hand an additional $\frac{1}{2}$ to $\frac{3}{4}$ turn.
8. Reconnect power and reset filter service advisory.
9. Restart the machine to check for leaks.

Operations and Maintenance Manual

6.4 Air/Oil Separator

The air/oil separator should be changed every 4000 hours, once a year, or when there is excessive oil vapor in the discharge air, or as indicated by a maintenance indicator, which ever occurs first. Higher temperature operation can cause the element to plug faster. Consistent operation in temperatures over 180 °F will require more frequent separator element changes.

 **DANGER**

Hot oil under pressure will cause severe injury, death, or property damage.

Be sure the compressor is shutdown and pressure relieved before attempting to remove the oil filter, separator, oil fill, or change the oil.

Separator Element Replacement

Switch off the unit, disconnect the power, and lockout and tag to prevent accidental starting.

1. Allow one minute after stopping for the system to settle and the pressure to be relieved.
2. Using a strap wrench, remove the old element and gasket.
3. Clean the gasket surface with a clean rag.
4. Apply a light film of oil to the new gasket.
5. Hand tighten the new element until the new gasket is seated in the gasket groove.
6. Continue tightening by hand an additional 1/2 to 3/4 turn.
7. Reconnect power, reset separator service advisory.
8. Restart the machine to check for leaks.

6.5 Renewal Element Part Numbers

Model	Air Filter	Oil Filter	Separator	4000 Hour Kit
SE5	1260007	1260006	1260008	1486301
SE7.5	1260007	1260006	1260008	1486301
SE10	1260007	1260006	1260008	1486301
SE15	1260004	1260003	1260008	1486303

Use only genuine Curtis renewal parts. Substitute parts can reduce the performance and void the warranty.

Operations and Maintenance Manual

6.6 Lubricant

Your compressor has been filled and tested with a high quality synthetic compressor lubricant. It has the advantage of extended service life, high temperature operation, easy start-up when cold, reduced sludge and lacquer buildup, and is completely compatible with all seals, gaskets, and other compressor materials.

When operating in severe conditions it will be necessary to change the lubricant more frequently. Temperature of operation has the most significant effect on the life of the lubricant. The following chart shows the decrease in interval based on temperature.

(Figure 6-1)

Discharge Temperature	RS8000
Up to 180°F	8000 hrs
180 to 190°F	6000 hrs
190 to 200°F	4000 hrs
200 to 210°F	2000 hrs

To eliminate confusion concerning what type of lubricant to use, always use Curtis RS8000 Lubricants. If other lubricants are used, failures due to lubrication are not warrantable.



CAUTION

Plugged filters, coolers, and orifices can result from mixing different lubricants and conditioners. This will also void the warranty.

Be sure to use only Curtis Lubricants in refilling your compressor.

Operations and Maintenance Manual

Oil Analysis

Oil analysis is an excellent tool to add to your compressor maintenance program. At regular intervals you submit lubricant samples to a qualified laboratory. From this you receive a detailed report showing the lubricant condition, wear metals, and contaminants. The rate that these measurements change over time provides the basis for predictive compressor maintenance, saving you from unplanned machine downtime and unnecessary oil changes.



Hot oil under pressure will cause severe injury, death, or property damage.

Be sure the compressor is shutdown and pressure relieved before attempting to remove the oil filter, separator, oil fill, or change the oil.

Checking Oil Level and Adding Compressor Oil

1. Switch off the unit, disconnect the power, and lockout and tag to prevent accidental restarting.
2. Allow one minute after stopping the compressor for settling and the pressure to relieve.
3. Remove any dirt from around the fill cap, and then remove the fill cap.
4. Inspect the cap for damage and cleanliness. Replace if necessary.
5. The oil should be:
 - Filled up to the air end fill port visible after removing fill cap for the SE5
 - Visible in the window by the oil fill port on the side of the air end for the SE7.5-SE10.
 - Visible in the straw site glass on side of the air end for the SE15.
6. Replace the cap securely. Never put the cap on without tightening it immediately.

Changing Compressor Lubricant

1. Switch off the unit, disconnect the power, and lockout and tag to prevent accidental restarting.
2. Allow one minute after stopping the compressor for settling and the pressure to relieve.
3. Remove any dirt from around the fill cap, and then remove the fill cap. If the lubricant appears dirty or has a foul smell it should be replaced.
4. Drain the lubricant from the bottom of the air/oil receiver. Oil will drain more quickly and completely if it is warm from operation.
5. Close all drains and replace with fresh compressor oil to the proper level.
6. Replace the fill cap and run the unit.
7. Switch off the unit and disconnect the power to prevent accidental restarting.
8. Allow one minute after stopping the compressor for settling and the pressure to relieve.
9. Remove the fill cap to see if more lubricant should be added and to insure that there are no leaks.

Operations and Maintenance Manual

6.7 Thermostatic Valve

The thermostatic valve is a non-adjustable temperature control valve. On the compressor we use this valve to mix hot and cold oil. It will begin to open at 150-155°F and be full open at 170°F. This insures that the system temperature is above the pressure condensation point and there is minimal accumulation of water.

Recommended service interval of 8,000 hrs for SE5-SE15 Part # (1486310)

To repair this valve:

1. Switch off the unit, disconnect the power, and lockout and tag to prevent accidental starting.
2. Place a spill pan under the valve/filter assembly.
3. Make sure that all pressure is relieved from the system. Loosening the fill cap is an easy way to insure that the pressure is totally relieved.
4. Remove the retaining cap from the valve block.
5. Remove the cap and the internal parts. Take care to note the orientation of the spring, piston, and element.
6. Reassemble with the renewal parts.
7. Replace any volume of oil lost with fresh oil. Also replace the fill cap, if this was used to insure relief of the system pressure.
8. Return unit to service.

6.8 Minimum Pressure Valve

The minimum pressure valve is a non-adjustable spring biased check valve. It has been designed to maintain a minimum sump pressure of 70 psig. If the pressure is allowed to get too low, the oil carryover rate will increase and the separator could be damaged.

Air exiting the vent hole in the cap of the valve indicates an o-ring failure and it needs to be replaced. The air leaking into the spring cavity where the vent is located will change the operation of the valve.

Recommended service interval of 8,000 hrs for SE5 Part # (1486314)

Recommended service interval of 8,000 hrs for SE7.5-SE10 Part # (1486315)

Recommended service interval of 8,000 hrs for SE15 Part # (1486340)

To repair this valve:

1. Switch off the unit, disconnect the power, and lockout and tag to prevent accidental starting.
2. Place a spill pan under the valve.
3. Make sure that all pressure is relieved from the system. Loosening the fill cap is an easy way to insure that the pressure is totally relieved.

Operations and Maintenance Manual

4. Remove the cap at the top of the valve. It is spring loaded so be careful that it does not fly off.
5. Remove piston and seat.
6. Inspect the valve body for scratches and deterioration of the seating surfaces.
7. Replace old parts with the renewal parts and re-assemble the valve.
8. If you loosened the fill plug to insure pressure relief, replace it and tighten.
9. Return the unit to service.

6.9 Belts

Routine examination of the drive system is recommended to insure maximum compressor life. The belts need to be checked for wear and stretch.

To check the belts:

1. Switch off the unit, disconnect the power, and lockout and tag to prevent accidental restarting.
2. Allow one minute after stopping the compressor for settling and the pressure to relieve.
3. Remove the belt guard.
4. Inspect for any fraying or cracking of the belts. If there is any replace the belts.
5. Check the tension. The deflection should be about 1/64" per inch of span between the sheaves with about 4 pounds of force perpendicular to the belt.

To change the belts: (SE5 thru SE15)

1. Switch off the unit, disconnect the power, and lockout and tag to prevent accidental restarting.
2. Allow one minute after stopping the compressor for settling and the pressure to relieve.
3. Remove the belt guard.
4. Remove the belts.
5. Replace with new belts.

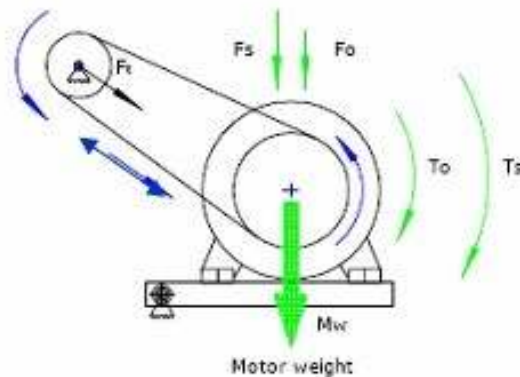

Operations and Maintenance Manual

Sheave Alignment

Any degree of sheave misalignment will result in a reduction of belt life. Misalignment whether parallel or angular should not exceed 1/16".

Parallel misalignment occurs when the shafts are parallel, but the face of the sheaves is not in alignment. Angular misalignment occurs when the shafts are not parallel.

An easy and effective method for checking the alignment in both directions is to use an accurate straight edge.

1. Switch off the unit, disconnect the power, and lockout and tag to prevent accidental restarting.
2. Allow one minute after stopping the compressor for settling and the pressure to relieve.
3. Remove the belt guard.
4. Lay the straight edge across the face of the motor sheave and check the alignment with the air end sheave.

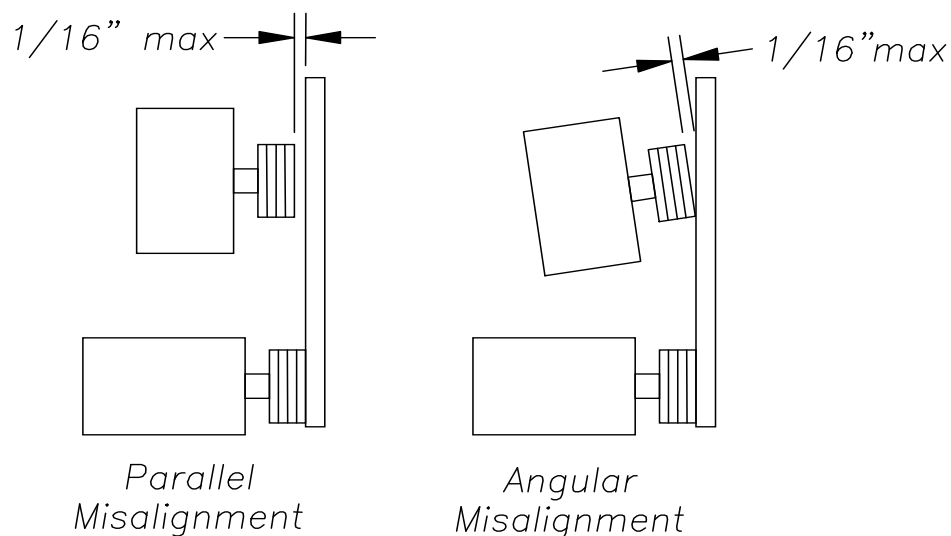

5. Then lay the straight edge across the face of the air end sheave and check the alignment with the motor sheave.
6. If the alignment gap is greater than 1/16" in either direction, loosen the belts as outlined in changing belts section and align the sheaves.
7. Reset the tension on the belts
8. Return the unit to operation.

Operations and Maintenance Manual

6.10 Fan

Check the fan for cracking, loose rivets, and bent or loose blades. Make sure that it is securely mounted and tighten the mounting screws if loose. Replace a damaged fan immediately.

6.11 Motor

The motors on the air compressor require routine attention too. Every 1000 hours of operation or six months, whichever comes first, check that the motor is clean and ventilation openings are clear.

The second area to maintain to insure long motor life is bearing lubrication. Bearing grease will lose its lubricating ability over time, not suddenly. The type of grease used, the temperature of operation, and the speed of the motor effect the life of the bearing lubrication. You should re-grease the bearings every 2000 hrs or once a year. Units in severe duty (dusty locations or high ambient temperatures) the time interval is 1000 hours.

A high quality ball or roller bearing grease with the following characteristics should be used:

	Standard Service	Hi-Temperature Service
Soap Type	Lithium	Lithium
Grease Viscosity SSU at 100°F	400 – 550	475 – 525
Worked Penetration	265 – 296	220 – 240
N-H Bomb min hrs for 20 psi drop at 210°F	750	1000
Bleeding, max weight % in 500 hrs at 212°F	10	3
Rust Inhibiting	Yes	Yes

Operations and Maintenance Manual



CAUTION

Over greasing is a major cause of bearing and motor failure. Make sure not to over grease or to introduce any contaminants during greasing.



WARNING

Rotating machinery can cause injury or death. Open main disconnect, tag and lockout power supply to the starter before working on the electric motor

To regrease the bearings:

Switch off the unit, disconnect the power, and lockout and tag to prevent accidental restarting.

1. Clean grease fittings.
2. Remove the relief plug and free the hole of hardened grease.
3. Add grease with hand operated grease gun until it appears at the shaft hole in the end plate or the relief plug outlet.
4. Re-connect the power, and run the unit for 20 minutes without the relief plug in place.
5. Switch off the unit, disconnect the power, and lockout and tag to prevent accidental restarting.
6. Re-install the grease relief plug.
7. Return unit to service.

Operations and Maintenance Manual

6.12 AIR END/MOTOR REMOVAL

Air end/motor removal and installation

(Note: It is important to have clear access to the air end/motor area)

Lifting devices are necessary for the removal and installation of the air end/motor

- A) Turn off compressor.
- B) Turn off main power and lock out to avoid accidental start-up.
- C) Remove all side access panels.
- D) Remove belt guard and belts from pulleys.
- E) Remove 3 hose fittings from the airend which are coming from the cooler.
- F) Remove 3 sensors (2-Pressure sensors & 1-Temperature sensor).
- G) Unplug PD (Position Differential) switch.
- H) Unplug solenoid coil from airend.
- I) Remove 4 air end mounting bolts.
- J) Remove air end

Installation of the air end

Reverse removal instructions and readjust belt tension before installing the belt guard screen.

Motor Removal

- K) Remove cover from motor junction box.
- L) Note wire connections.
- M) Remove wires and conduit connectors from the motor junction box.
- N) Remove 4 bolts from motor base studs.
- O) Lift and remove motor from cabinet.

To reinstall motor and air end, start with step (O) and reverse procedure.

Operations and Maintenance Manual

Product Recommended Maintenance

Operating Hours	Initial Start-Up	Recommended Maintenance Required					
	500	2000	4000	6000	8000	10000	12000
Air Filter		X	X	X	X	X	X
Oil Filter	X	X	X	X	X	X	X
Oil Separator			X		X		X
Oil, Food Grade (RS4000FG)			X		X		X
Oil, Synthetic (RS8000)					X		
Minimum Pressure Valve					X		
Suction valve						X	
Thermo valve							X
Motor bearing lubrication	X	X		X		X	
Belt					X		

NOTE:

Oil change intervals shown are for compressor operating temperatures below 200°F (93°C).

Reduced service periods apply at high temperature and high humidity environments.

Oil change intervals may vary based on oil sampling results.

MPV= 8000 hours or (1) once per year.

Suction Valve= 10,000 hours or (1) once every two years

Must use FS-Curtis Genuine Replacements parts and lubricants to maintain Warranty

Operations and Maintenance Manual

7.0 Troubleshooting

<p>Compressor will not start</p>	<ul style="list-style-type: none"> a. No power b. Fuses blown in the control circuit. c. Motor overload latch not reset. d. Heaters not installed in starter. e. Loose or missing wires or components in the control circuit. f. Incorrect voltage e.g. using 230 volt in a 460 volt system. g. Faulty temperature switch. h. Suction valve does not close. i. Pressure in oil separator tank.
<p>Unit starts – but shuts down immediately</p>	<ul style="list-style-type: none"> a. Pressure switch or timer failure. b. Incorrect heaters or adjusted too low in starter. c. High Air Temperature switch open due to restricted oil flow. d. Loose or missing electrical components. e. Pressure switch set too high. f. Motor overloads trip out. g. Low voltage.
<p>Compressor does not build up to the desired pressure.</p>	<ul style="list-style-type: none"> a. Inlet valve partially closed. b. Belt slippage. c. Restricted inlet air cleaner. d. Excessive air demand. e. Defective pressure gauge. f. Pressure switch set too low. g. Excessive pressure drop across the separator element. h. Solenoid valve stuck open. i. Air end malfunction – excessive clearance or rotor movement. j. Compressor sized too small. k. Safety valve keeps discharging.

Operations and Maintenance Manual

<p>Compressor will not load</p>	<ul style="list-style-type: none"> a. Pressure switch set too low b. Inlet valve will not open. c. Faulty solenoid valve.
<p>Capacity (delivery) is below stated amount</p>	<ul style="list-style-type: none"> a. Restricted inlet air filter. b. Inlet valve partially closed. c. Air pressure set too high. d. Insufficient oil flow. e. Solenoid valve malfunction. f. Belt slippage. g. Leakage in air system. h. Worn air end.
<p>Compressor surges</p>	<ul style="list-style-type: none"> a. Erratic air demand. b. Customer air system too small for supply. c. Minimum pressure valve. d. Pressure switch differential too low for the system conditions. e. Loose electrical connection between the controller and the solenoid valve. f. Faulty pressure transducer. g. Faulty solenoid valve. h. Faulty pressure relief valve.
<p>Excessive Oil Consumption</p>	<ul style="list-style-type: none"> a. Overfilled sump. b. Broken oil line. c. Plugged oil return line. d. Operating below rated pressure. e. Damaged or dirty separator. f. Lightly loaded or excessive load/unload cycles. g. Using incorrect oil.

Operations and Maintenance Manual

<p>High Temperature Shutdown</p>	<ul style="list-style-type: none"> a. Elevated ambient temperature. b. Low sump oil level. c. Plugged oil filter. d. Restricted cooling airflow. e. Clogged heat exchanger. f. Thermal bypass is leaking g. Faulty high air temperature switch. h. Delivery pressure set too high. i. Panels are open. j. Exhaust air is restricted.
<p>High power consumption</p>	<ul style="list-style-type: none"> a. Plugged separator. b. Plugged aftercooler. c. Improper air pressure switch setting. d. Too low of a line voltage. e. Electrical phase imbalance. f. Imminent motor failure. g. Imminent air end failure h. Belt slippage i. Loose electrical connection
<p>Safety valve discharges</p>	<ul style="list-style-type: none"> a. Over pressure switch not set correctly. b. Inlet valve not closing properly in relation to air demand. c. Plugged separator. d. Faulty minimum pressure check valve. e. Faulty safety valve. f. Incorrect set point on safety valve

8.0 Maintenance Log

Model: _____ Serial Number: _____

Date	Hourmeter Reading	Changed				Greased Motor Bearings	Cleaned Cooler	Checked Fitting Tightness
		Air Filter	Oil Filter	Oil	Separator			

NOTES