

Replacement Parts

Applies to: Serial No. Explanation; Model No. Explanation;
 Replacement Ignition Systems and Gas Valves by Serial No. Code;
 and Maxitrol System Components by Serial No. Suffix

Table of Contents

SAFETY WARNINGS AND GUIDELINES	1
Instructions for Selecting a Replacement Ignition Controller and/or Valve	2
Serial Number and Model Codes	3
Serial No. Decoding	3
Serial Number Key - Month and Year of Manufacture.....	4
Heater Serial No. PREFIX and SUFFIX Codes	5
Model No. Decoding.....	5
Safety Pilot or Ignition System by Serial No. Code.....	6-10
Type of Gas Valve by Serial No. Code	11-27
Maxitrol Components for Electronic Modulation	28-31

WARNINGS

Selection of replacement control parts from this manual and all servicing to Reznor® products must be done by a Reznor® Distributor or other qualified technician. Improper selection or servicing could result in severe personal injury, death, or property damage. Thomas & Betts Corporation will accept no responsibility or liability as a result of improper servicing of Reznor® products.

In the United States, all installations of Reznor® gas-fired products must be in accordance with the Standards of the NFPA (National Fire Protection Association), the National Fuel Gas Code, and all local authorities. In Canada, all installations of Reznor® gas-fired products must be in accordance with the CAN/CSA Installation Code for Gas Burning Appliances and Equipment and all provincial and local authorities.

SAFETY WARNINGS AND GUIDELINES FOR A QUALIFIED SERVICE TECHNICIAN

- **When selecting a replacement control, always have the complete Model No. and Serial No. of the heater. (See pages 2-4 for instructions on decoding those numbers.) If the model and serial number are not available, contact your Reznor® Representative. DO NOT SELECT REPLACEMENT CONTROLS WITHOUT COMPLETE INFORMATION.**
- **Before servicing a heater, always turn off the gas and the power supply. Because of the electrical safety features, never turn off the power supply without turning off the gas.**
- **The electrical operating valve is the primary safety shutoff. The gas supply line must be free of dirt or scale before connecting the valve.**
- **Leak test all gas connections including pilot connections. Test using a commercial leak detecting or a soap solution. WARNING: DO NOT TEST WITH OPEN FLAME. If a leak cannot be stopped by tightening, replace the part.**
- **In the event of pilot outage or improper ignition, wait at least five minutes before attempting to relight the heater.**
- **After any service is completed, always test for proper operation. Re-connect the electrical supply and turn on the gas. Verify against operating sequence information on the heater and in the heater installation manual. Safety check the installation and equipment. CHECK THAT ALL SAFETY DEVICES ARE FUNCTIONING PROPERLY.**

FOR YOUR SAFETY

WARNINGS

The use and storage of gasoline or other flammable vapors and liquids in the vicinity of this heating appliance is hazardous.

DANGER

The gas burner in all Reznor® gas-fired equipment is designed and equipped to provide safe, complete combustion. However if the installation does not permit the burner to receive the proper supply of combustion air, complete combustion may not occur. The result is incomplete combustion which produces carbon monoxide, a poisonous gas that can cause death. Safe operation of indirect-fired gas burning equipment requires a properly operating vent system which vents all the products to the outside atmosphere. Failure to provide proper venting will result in a health hazard which could cause serious personal injury or death.

Always comply with the combustion air requirements in the installation codes and instructions. Combustion air at the burner should be regulated only by manufacturer-provided equipment. **NEVER RESTRICT OR OTHERWISE ALTER THE SUPPLY OF COMBUSTION AIR TO ANY HEATER.** Indoor units installed in a confined space must be supplied with air for combustion as required by code and in the installation manual. **ON INDIRECT-FIRED EQUIPMENT, MAINTAIN THE VENT SYSTEM IN PROPERLY FUNCTIONING CONDITION.** Direct-fired and other unvented installations should provide for air changes as required by applicable installation codes.

Instructions for Selecting a Replacement Ignition Controller and/or Valve

Serial No. Codes - Identify the code of the valve or ignition controller needing replacement. Serial No. Codes are defined on pages 3-5. **IMPORTANT NOTE:** Serial No. and Model No. Codes apply only to original equipment.

IGNITION CONTROLLER - To select the replacement ignition controller, locate the Serial No. safety pilot code in the listing on pages 6-10. Select carefully, reading all applicable notes. If the part is no longer available from Thomas & Betts, a functional replacement or alternative instructions are listed.

VALVE - To select a replacement valve, locate the Serial No. valve code in the listing on pages 12-19. The valve supplied on the heater is described. If the valve is no longer available from Thomas & Betts, a functional replacement or alternative instructions may be listed. Select carefully, reading all applicable notes. All valve code notes are on pages 20-22. See pages 23-27 for representative illustrations of valves.

VALVE WIRING TERMINAL IDENTIFICATION/WIRE COLOR				
Valve Manufacturer	Common	Pilot	Main or Low Stage	High Stage
Honeywell	TR	TH-TR	TH	
	PV-MV	PV	MV	
	C	PV	MV	H1
White-Rodgers	C	P	M	
	C1-C2	--	W1	W2
	2	4	1	3
Robertshaw	C	P	M	
Original Wire Color (exceptions possible)	White or Brown	Blue	Black	Red

IMPORTANT: The controls identified in this form are the controls factory-installed on units manufactured beginning in 1963. Much of the earlier information provided is for reference only and does not mean that replacing parts is recommended or that replacement parts are available. See date code information on page 4.

IMPORTANT ORDERING REMINDERS

1. Always include complete heater model and serial number so that any specification change can be considered for parts shipment. It can save time and expense.
2. Specifications are subject to change without notice.
3. We reserve the right to substitute functional replacements.
4. Order either by Kit or Component Part No.

Serial Number and Model Codes

Example of a Rating Plate that applies to most Reznor® Models showing Model and Serial Numbers

REZNOR®
Mercer, PA 16137

DUCT FURNACE
CATEGORY I
FOR INDUSTRIAL/COMMERCIAL USE ONLY NRTL
DESIGN CERTIFIED UNDER ANSI Z83.8a-1998

MODEL HX100E-8-S
SERIAL# EBDJ66W8N12345
115 VOLTS 1PH 60HZ MAXIMUM TOTAL INPUT .5AMPS
TYPE OF GAS NATURAL

ORIFICE SIZE #41 DRILL HAS BEEN FACTORY ADJUSTED
FOR USE AT 0-2000 FEET (0-610 METERS) OF ALTITUDE

NORMAL INPUT	100000	100000 BTU/HR
OUTPUT CAPACITY	80000	80000 BTU/HR
MIN. INPUT (2, M, MB, MV MODELS)	50000	50000 BTU/HR
NORMAL MANIFOLD PRESSURE		3.5 IN. W.C.
MIN. PERMISSIBLE GAS SUPPLY PRESSURE FOR PURPOSE OF INPUT ADJUSTMENT		5.0 IN. W.C.
MAXIMUM THROUGHPUT		3704 CFM
MINIMUM THROUGHPUT		988 CFM

CLEARANCE TO COMBUSTIBLE CONSTRUCTION: TOP - 6";
FLUE CONNECTION - 6"; SERVICE SIDE - WIDTH OF UNIT;
OPPOSITE SIDE - 6"; BOTTOM - 3", MAY BE INSTALLED ON
NONCOMBUSTIBLE FLOORS.
INSTALL ON THE POSITIVE PRESSURE SIDE OF AIR
CIRCULATING BLOWER.
THIS UNIT MAY BE INSTALLED DOWNSTREAM FROM A
REFRIGERATION SYSTEM (USE DRAIN OPTION CS1).
FOR ALTERNATE INSTALLATION, USE THE LATEST OF THE
APPROPRIATE STANDARDS LISTED BELOW:
FOR AIRCRAFT HANGARS USE STANDARD ANSI/NFPA 409
FOR PARKING STRUCTURES USE STANDARD ANSI/NFPA 88A
FOR REPAIR GARAGES USE STANDARD ANSI/NFPA 88B



Serial No. Decoding

Sample of a Serial No. for Units manufactured from 1963 through 1974:

OA	1	2	N	693	Serial No.
1	2	3	4	5	Element

Sample of a Serial No. for Units manufactured beginning in 1975:

BDJ	66	W8	N	12345	Serial No.
1	2	3	4	5	Element

Element Key:

- 1 = Month and Year of manufacture; see page 4.
- 2 = Type of safety pilot or ignition system; see pages 6-10 for Code explanation.
- 3 = Type of valve; see pages 12-22 for Code explanation and illustrations on pages 23-27. (A dash indicates that the valve was field supplied.)
- 4 = Type of gas that the heater was originally manufactured to burn
D = Dual fuel, natural and propane; L = Propane; N = Natural
(Check for gas conversion label.)
- 5 = Consecutive number of heater manufactured. Used for identification purposes only.

In addition to the basic five elements, the serial number may also include **prefix and/or suffix codes**. See page 5 for a listing and explanation of these codes. All codes apply to original equipment only.

Example of a Reznor® MAPS® Unit Rating Plate Showing Model and Serial Numbers

REZNOR®
MERCER, PA, U.S.A. 16137
MADE IN USA

FOR INDUSTRIAL/COMMERCIAL USE ONLY
SUITABLE FOR OUTDOOR USE

MODEL [A] [B]
SERIAL NO. []

ELECTRICAL

[D] VOLTS +/- 10%	[D] PHASE	[D] HZ	[F] AMPS
MINIMUM CIRCUIT AMPACITY (MCA)			[G] AMPS
MAXIMUM FUSE SIZE/*CKT BREAKER			

SUPPLY AIR BLOWER MOTOR	QTY	FLA (EA)	HP (EA)
CONDENSER FAN MOTOR (S)	[T]	[U]	[Z]
COMPRESSOR A	[H]	[I]	[J]
COMPRESSOR B	[K]	[L]	[M]
COMPRESSOR C	[N]	[O]	[P]
COMPRESSOR D	[Q]	[R]	[S]
COMPRESSOR E	[GG]	[HH]	[II]

CIRCUITS A B C D E

REFRIGERANT - R-410a CHARGE - LBS [V] [W] [X] [Y] [JJ]

TEST PRESSURES HIGH 600PSIG LOW 45PSIG

EQUIPPED FOR OPERATION AT AN AIR FLOW OF [CC] SCFM
AGAINST A STATIC PRESSURE OF [DD] INCHES WATER COLUMN
DRIVE RPM [EE]

WIRE DIAGRAM [FF]

REFER TO RATING PLATE IN THE FURNACE SECTION (WHEN USED)
FOR ADDITIONAL INFORMATION.

*HACR TYPE REQUIRED PER NEC

Rating Plate Key for MAPS® Model Series RCA, RDA, RCB, RDB, RCC, and RDC: (NOTE: To decode a MAPS Serial No., see page 4.)

- | | |
|--|--------------------|
| A = Model | CC = SCFM Airflow |
| B = Manufacturing Date (Month/Year) | DD = External |
| C = Blower Motor HP | Static Pressure |
| D = Volts/Phase/Hertz | (" w.c.) |
| E = Full Load Amps (FLA) of Blower Motor | EE = Drive (Option |
| F = Minimum Circuit Ampacity (MCA) | AM) |
| G = Maximum Fuse Size (MOP) | FF = Wiring Dia- |
| H = Quantity - Compressor A | gram No. |
| I = Rated Load Amps of Compressor A | GG = Quantity - |
| J = Locked Rotor Amps of Compressor A | Compressor E |
| K = Quantity - Compressor B | HH = Rated Load |
| L = Rated Load Amps of Compressor B | Amps of Com- |
| M = Locked Rotor Amps of Compressor B | pressor E |
| N = Quantity - Compressor C | II = Locked Rotor |
| O = Rated Load Amps of Compressor C | Amps of Com- |
| P = Locked Rotor Amps of Compressor C | pressor E |
| Q = Quantity - Compressor D | JJ = Refrigerant |
| R = Rated Load Amps of Compressor D | Charge (lbs) - |
| S = Locked Rotor Amps of Compressor D | Circuit E |
| T = Quantity Condenser Fan Motors | |
| U = Rated Load Amps of Condenser(s) | |
| V = Refrigerant Charge (lbs) - Circuit A | |
| W = Refrigerant Charge (lbs) - Circuit B | |
| X = Refrigerant Charge (lbs) - Circuit C | |
| Y = Refrigerant Charge (lbs) - Circuit D | |
| Z = Condenser Fan Motor HP | |

Serial Number and Model Codes (cont'd)

Decoding a MAPS® Unit Serial No.

Serial No. Sample: **3 BIJ 789 BK 08 N 96 7D**

Elements of No.: **1 | 2 | 3 | 4 | 5 | 6 | 7 | 8**

Elements 1-5 apply to all MAPS® models.
 Elements 6-8 apply to a MAPS® with a gas heat section .

- Key:
- 1 = Phase (1 or 3)
 - 2 = Date CODE (See table below.)
 - 3 = Consecutive number
 - 4 = Drive (See Form P-MAPSII or P-MAPSIII)
 - 5 = Motor HP (See explanation on the right.) →
 - 6 = Type of Gas (N = Natural)
 - 7 = Ignition CODE (See pages 6-10.)
 - 8 = Valve CODE (See pages 12-22.)

Motor HP	Serial No. Code
1/2	03
3/4	04
1	05
1-1/2	06
2	07
3 (3450 rpm)	08
5 (3450 rpm)	09
7-1/2	11
15	12
10	13
20	14
3 (1800rpm)	15
5 (1800rpm)	16

Serial Number Key - Month and Year of Manufacture

Year	Jan	Feb	Mar	Apr	May	June	July	Aug	Sept	Oct	Nov	Dec
1963	OA	OB	OC	OD	OE	OF	OG	OH	OI	OJ	OK	OL
1964	PA	PB	PC	PD	PE	PF	PG	PH	PI	PJ	PK	PL
1965	QA	QB	QC	QD	QE	QF	QG	QH	QI	QJ	QK	QL
1966	RA	RB	RC	RD	RE	RF	RG	RH	RI	RJ	RK	RL
1967	SA	SB	SC	SD	SE	SF	SG	SH	SI	SJ	SK	SL
1968	TA	TB	TC	TD	TE	TF	TG	TH	TI	TJ	TK	TL
1969	UA	UB	UC	UD	UE	UF	UG	UH	UI	UJ	UK	UL
1970	VA	VB	VC	VD	VE	VF	VG	VH	VI	VJ	VK	VL
1971	WA	WB	WC	WD	WE	WF	WG	WH	WI	WJ	WK	WL
1972	XA	XB	XC	XD	XE	XF	XG	XH	XI	XJ	XK	XL
1973	YA	YB	YC	YD	YE	YF	YG	YH	YI	YJ	YK	YL
1974	ZA	ZB	ZC	ZD	ZE	ZF	ZG	ZH	ZI	ZJ	ZK	ZL
1975	AAA	AAB	AAC	AAD	AAE	AAF	AAG	AAH	AAI	AAJ	AAK	AAL
1976	ABA	ABB	ABC	ABD	ABE	ABF	ABG	ABH	ABI	ABJ	ABK	ABL
1977	ACA	ACB	ACC	ACD	ACE	ACF	ACG	ACH	ACI	ACJ	ACK	ACL
1978	ADA	ADB	ADC	ADD	ADE	ADF	ADG	ADH	ADI	ADJ	ADK	ADL
1979	AEA	AEB	AEC	AED	AEE	AEF	AEG	AEH	AEI	A EJ	AEK	AEL
1980	AFA	AFB	AFC	AFD	AFE	AFF	AFG	AFH	AFI	AFJ	AFK	AFL
1981	AGA	AGB	AGC	AGD	AGE	AGF	AGG	AGH	AGI	AGJ	AGK	AGL
1982	AHA	AHB	AHC	AHD	AHE	AHF	AHG	AHH	AHI	AHJ	AHK	AHL
1983	AIA	AIB	AIC	AID	AIE	AIF	AIG	AIH	AII	AIJ	AIK	AIL
1984	AJA	AJB	AJC	AJD	AJE	AJF	AJG	AJH	AJI	AJJ	AJK	AJL
1985	AKA	AKB	AKC	AKD	AKE	AKF	AKG	AKH	AKI	AKJ	AKK	AKL
1986	ALA	ALB	ALC	ALD	ALE	ALF	ALG	ALH	ALI	ALJ	ALK	ALL
1987	AMA	AMB	AMC	AMD	AME	AMF	AMG	AMH	AMI	AMJ	AMK	AML
1988	ANA	ANB	ANC	AND	ANE	ANF	ANG	ANH	ANI	ANJ	ANK	ANL
1989	AOA	AOB	AOC	AOD	AOE	AOE	AOG	AOH	AOI	AOJ	AOK	AOL
1990	APA	APB	APC	APD	APE	APF	APG	APH	API	APJ	APK	APL
1991	AQA	AQB	AQC	AQD	AQE	AQF	AQG	AQH	AQI	AQJ	AQK	AQL
1992	ARA	ARB	ARC	ARD	ARE	ARF	ARG	ARH	ARI	ARJ	ARK	ARL
1993	ASA	ASB	ASC	ASD	ASE	ASF	ASG	ASH	ASI	ASJ	ASK	ASL
1994	ATA	ATB	ATC	ATD	ATE	ATF	ATG	ATH	ATI	ATJ	ATK	ATL
1995	AUA	AUB	AUC	AUD	AUE	AUF	AUG	AUH	AUI	AUJ	AUK	AUL
1996	AVA	AVB	AVC	AVD	AVE	AVF	AVG	AVH	AVI	AVJ	AVK	AVL
1997	AWA	AWB	AWC	AWD	AWE	AWF	AWG	AWH	AWI	AWJ	AWK	AWL
1998	AXA	AXB	AXC	AXD	AXE	AXF	AXG	AXH	AXI	AXJ	AXK	AXL
1999	AYA	AYB	AYC	AYD	AYE	AYF	AYG	AYH	AYI	AYJ	AYK	AYL
2000	AZA	AZB	AZC	AZD	AZE	AZF	AZG	AZH	AZI	AZJ	AZK	AZL
2001	BAA	BAB	BAC	BAD	BAE	BAF	BAG	BAH	BAI	BAJ	BAK	BAL
2002	BBA	BBB	BBC	BBD	BBE	BBF	BBG	BBH	BBI	BBJ	BBK	BBL
2003	BCA	BCB	BCC	BCD	BCE	BCF	BCG	BCH	BCI	BCJ	BCK	BCL
2004	BDA	BDB	BDC	BDD	BDE	BDF	BDG	BDH	BDI	BDJ	BDK	BDL
2005	BFA	BEB	BEC	BED	BEE	BEF	BEG	BEH	BEI	BEJ	BEK	BEL
2006	BFA	BFB	BFC	BFD	BFE	BFF	BFG	BFH	BFI	BFJ	BFK	BFL
2007	BGA	BGB	BGC	BGD	BGE	BGF	BGG	BGH	BGI	BGJ	BGK	BGL
2008	BHA	BHB	BHC	BHD	BHE	BHF	BHG	BHH	BHI	BHJ	BHK	BHL
2009	BIA	BIB	BIC	BID	BIE	BIF	BIG	BIH	BII	BIJ	BIK	BIL
2010	BJA	BJB	BJC	BJD	BJE	BJF	BJG	BJH	BJI	BJJ	BJK	BJL
2011	BKA	BKB	BKC	BKD	BKE	BKF	BKG	BKH	BKI	BKJ	BKK	BKL
2012	BLA	BLB	BLC	BLD	BLE	BLF	BLG	BLH	BLI	BLJ	BLK	BLL
2013	BMA	BMB	BMC	BMD	BME	BMF	BMG	BMH	BMI	BMJ	BMK	BML
2014	BNA	BNB	BNC	BND	BNE	BNF	BNG	BNH	BNI	BNJ	BNK	BNL
2015	BOA	BOB	BOC	BOD	BOE	BOF	BOG	BOH	BOI	BOJ	BOK	BOL
2016	BPA	BPB	BPC	BPD	BPE	BPF	BPG	BPH	BPI	BPJ	BPK	BPL
2017	BQA	BQB	BQC	BQD	BQE	BQF	BQG	BQH	BQI	BQJ	BQK	BQL
2018	BRA	BRB	BRC	BRD	BRE	BRF	BRG	BRH	BRI	BRJ	BRK	BRL

Heater Serial No. PREFIX and SUFFIX Codes

In addition to the five elements found in every serial number, the heater serial number may be coded with prefixes and suffixes that further identify optional equipment or capabilities applicable to that particular unit. All prefix and suffix codes are listed below. See pages 3-4 for explanation of the basic elements of a serial number.

Serial Number PREFIX Codes and Definitions:

Code	Explanation
E	= E3 (409) stainless steel heat exchanger
S	= 316 or 321 stainless steel heat exchanger

Serial Number SUFFIX Codes and Definitions:

Code	Explanation
B	= Baso pilot (indicates Baso pilot in place of General Controls pilot)
CA	= Constant air volume
EE	= Energy efficient motor
FD	= Fan duct furnace (spotter)
HV	= High throw fan assembly
MP1	= Modulating gas control with 20%-100% firing rate (AG39)
MP2	= Modulating gas control with 20%-100% firing rate with signal conditioner for DDC (AG40)
MP3	= Modulating gas control 20-100% firing rate on 1st furnace; 2-stage on 2nd (AG41)
MP4	= Modulating gas control 20-100% on 1st furnace; 2-stage on 2nd - w/signal conditioner for DDC (AG42)
MP5	= 1-stage on 1st furnace; 2-stage on 2nd furnace (AG43)
MP6	= 1-stage on 1st furnace; 2-stage on 2nd furnace - with signal conditioner for DDC (AG44)
MV1	= Maxitrol 20AH Electronic Modulation (50-100%) System (AG7 for single furnace)
MV2	= Maxitrol 30AH Electronic Modulation (50-100%) System (AG7 for multiple furnaces)
MV3	= Maxitrol 21H Electronic Modulation (50-100%) System (AG8 for single furnace)
MV4	= Maxitrol 21HR Electronic Modulation (50-100%) System (AG9 for single furnace)
MV5	= Maxitrol 31H Electronic Modulation (50-100%) System (AG8 for multiple furnaces)
MV6	= Maxitrol 31HR Electronic Modulation (50-100%) System (AG9 for multiple furnaces)
MV7	= Maxitrol 14 Electronic Modulation System (AG30 and AG31)
MV8	= Maxitrol 14A and 14B Electronic Modulation Systems (AG32 and AG35)
MV9	= Maxitrol 44 Electronic Modulation System (AG33)
MVA	= Maxitrol Electronic Modulation (50-100%) System w/Signal Conditioner for DDC on Indirect-Fired Equipment (AG21)
MVB	= Maxitrol 94 Electronic Modulation System for Paint Booth for Direct-Fired Equipment (AG36)
MVC	= Maxitrol Electronic Modulation System with Signal Conditioner for DDC on Direct-Fired Equipment (AG37)
MVD	= Maxitrol DFM14E Digital Control System (AG47) (Direct-fired RDF or DV)
MVE	= Maxitrol DFM 44E Digital Control System (AG48) (Direct-fired RDF or DV)
MVF	= Maxitrol DFM 44E Digital Control System with Remote Sensor (AG51) (RDF or DV)
RA	= Recirculation air
TE	= Totally enclosed motor
TS	= Two speed motor
VA	= Variable air volume
X	= Manufactured in Mexico

For a list of components of Maxitrol electronic modulation systems used on Model Series X, SC, RX, RPV, RG, RP, and EEDU indirect-fired equipment, see pages 25-27. For list of components of Maxitrol electronic modulation systems used on Model Series ADF, DV, and RDF direct-fired equipment, see pages 27-28.

(Reference NOTE: For PREEVA indirect-fired models, see Form P-PREEVA for modulation control components.)

Model No. Decoding

HX	100	8	S
Model	Size	Series	Suffix

The Model No. may or may not include suffix code(s) that further identify the heater. See the listing in the table for their identification.

*Effective 12/96, Codes J, JR, and Y are no longer used.

Heater Model No. SUFFIX Codes

SUFFIX Code	Explanation
-2	= Two stage heating/MUA control
-2L	= Two stage control (heating/MUA) with 33% low fire and constant thermal efficiency (AG60, AG61, AG62)
-C	= Unit with a C.G.A. rating plate
-CV	= Common vent
-D2	= Digital control, space temperature, 2-stage heating/3-stage cooling (DG1)
-D2J	= Digital control, electronic modulation heating/3-stage cooling (DG2)
-DM	= Digital control, discharge temperature (makeup air), 2-stage heating/3-stage cooling (DG5)
-DMJ	= Digital control, discharge temperature (makeup air), electronic modulation heating/3-stage cooling (DG6)
-E	= Intermittent spark pilot (Applies to Models F, B, X, XE, XL, XLB that have a standard match lit pilot; models that have a standard spark pilot do not have this code.)
-H	= Orificed for high altitude
-IL	= Manifold arrangement and remote console for Illinois School Code
*-J	= Makeup air (code appears on blower cabinet plate only)
*-JR	= Makeup air with evaporative cooling (code appears on blower cabinet plate only)
-LN	= Low noise
-M	= Mechanical modulation
-MB	= Mechanical modulation with full fire bypass
-MP	= Electronic modulation (20-100% firing rate)
-MV	= Electronic modulation (50-100% firing rate)
-R	= Evaporative cooling
-S	= Stainless steel heat exchanger
-W	= Wide heater cabinet on Models RX75 and 100 Series 5 and 6
*-Y	= High fire lightoff
-Z	= Equipped with "Z" baffle for 4-foot stack extension

Safety Pilot or Ignition System Originally Supplied, Identified by Serial No. Code -- See Serial No. Decoding on pages 3-4. (N/A = Not available; see other notes below.)

Serial No. Code	Mfr ¹	Description	Replacement P/N ²
1	J/C	8856-5	³ N/A
2	J/C	861-4	³ N/A
3	G/C	A100G741 (3-wire)	³ N/A
4	J/C	856-A5	³ N/A
5	J/C	619 Automatic relight system - 115 volt transformer	³ N/A
6	J/C	619 Automatic relight system - 220 volt transformer	³ N/A
7	J/C	619 Automatic relight system - 24 volt transformer	³ N/A
8	J/C	A100G544 (2-wire)	³ N/A
9	G/C	Safety Pilot is part of B57, B59 valve	³ N/A
10	T	32T Automatic relight	N/A
01	J/C	Remote push button relighting system non-100% shutoff (includes 861-4, 115 volt push button station)	³ N/A
02	J/C	Remote push button relighting system non-100% shutoff (includes 861-4, 230 volt push button station)	³ N/A
03	J/C	Remote push button relighting system 100% shutoff (includes 861-4, 115 volt pilot valve, 115 volt push button station)	³ N/A
04	J/C	Remote push button relighting system 100% shutoff (includes 861-4, 230 volt pilot valve, 230 volt push button station)	³ N/A
05	J/C	Remote push button relighting system non-100% shutoff (includes 861-4, 24 volt push button station)	³ N/A
06	J/C	Remote push button relighting system 100% shutoff (includes 861-4, 24 volt pilot valve, 24 volt push button station)	³ N/A
07	T	32T Recycling safety pilot switch	³ N/A
08	J/C	Safety pilot is part of Baso 92D2204A valve	³ N/A
09	J/C	Safety pilot is part of Baso CS212A-2	³ N/A
11	J/C	Safety pilot is part of Baso CS222A-1	³ N/A
12	M/H	Safety pilot is part of M/H Y343B	³ N/A
13	J/C	G13BG01 spark ignition system	³ N/A
14	M/H	RA890E protector relay	³ N/A
15	J/C	Part of G-28 spark ignition, non-100% shutoff	³ N/A
16	J/C	Part of 67800-2T's master control	³ N/A
17	J/C	G18MG02 spark ignition system - For replacement, use ignition conversion package	³ N/A
18	M/H	C591A002 pilotstat	³ N/A
19	J/C	G19MG02 automatic relight, 100% shutoff - For replacement, use ignition conversion package	³ N/A
20	W/R	30A48 with 50" lead	³ N/A
21	W/R	30A46 with 50" lead	³ N/A
22	J/C	G29BG01 automatic relight, non-100% - For replacement, use ignition conversion package	³ N/A
23	J/C	G29BG02 automatic relight, 100% shutoff - For replacement, use ignition conversion package	³ N/A
24	J/C	830 - 1/2 safety pilot valve	³ N/A
25	J/C	G28MG01, 100% (Model RHD Series)	³ N/A
26	F	Spark ignition system 05-120103-000 with combination valve, 100% shutoff - See Code 32	³ N/A
27	J/C	861-4	³ N/A
28	G/C	A100G741	³ N/A
29	J/C	G19 Automatic relight system - For replacement, use ignition conversion package	³ N/A
30	G/C	A100G544	³ N/A
31		Part of combination valve with standing pilot	
32	F	Spark ignition, non-100%	³ N/A
33	J/C	G18BG02 spark ignition, non-100%	³ N/A
34	J/C	G33BAG-1 spark ignition, 100% shutoff - For replacement, use ignition conversion package	³ N/A
35	F	05-13031-501 spark ignition, 100% shutoff (Model DFT)	³ N/A
36	F	G13CG-1 spark ignition, 100% shutoff (Model DFT)	³ N/A
37	M/H	R4795A-1016 spark ignition, 100% shutoff	³ N/A
	G/C	with K3R11A2N4 pilot line solenoid valve (Model DFT)	³ N/A
38	W/R	5070A-1 spark ignition, 100% shutoff (Model DFT)	³ N/A
39	M/H	R4795A-1016 spark ignition, 100% shutoff	³ N/A
	G/C	with K3R11A2N4 pilot line solenoid valve (Model DFT)	³ N/A
40	J/C	G60AAG-3 ignition controller (used with 100% recycling pilot)	³ N/A
41	J/C	G60AAG-3 ignition controller (used with non-100% relight)	³ N/A
42	J/C	G60AAG-3 ignition controller (used with 100% shutoff and Y79 lockout device)	³ N/A
43	F	No. 05-142202-005 spark ignition (Model DFT 250, 260, 295, 325)	³ N/A
44	J/C	G60QBG-7 ignition controller with valve and regulator all in one body -	³ N/A
45	J/C	G60CPG-1 ignition controller, propane gas with separate lockout	³ N/A
46	J/C	G60QBG-7 ignition controller, natural gas with lockout, Y79 timing device	³ N/A
47	J/C	G60PFH ignition controller with lockout all in one body, natural or propane gas	³ N/A





¹ F = Fenwall; G/C = General Controls; M/H = Minneapolis Honeywell; J/C = Johnson Controls; T = Thermodisc; W/R = White-Rodgers



² Functional replacement may require field-furnished wiring.

³ This item is no longer available. Suggest you contact the control manufacturer for replacement or functional replacement.

Safety Pilot or Ignition System Originally Supplied, Identified by Serial No. Code (cont'd) -- See Serial No. Decoding on pages 3-4. (N/A = Not available; see other notes below.)

Serial No. Code	Mfr ¹	Description	P/N	Replacement P/N ²
48	J/C	G60QRH-1 ignition controller, propane gas valve with regulator and lockout all in one body	N/A	³ N/A
49	M/H	L626B3	N/A	³ N/A
50	J/C	G65BCG-1 ignition controller and natural gas valve with regulator all in one body, 1/2"	67983-N/A	³ N/A
51	J/C	G65DCM-1 ignition controller & propane gas valve w/regulator & lockout, 1 body, 1/2"	68055-N/A	³ N/A
52	J/C	G65BBG-4 ignition controller and natural gas valve with regulator all in one body, 1/2"	79887-N/A	³ N/A
53	J/C	G65BKG-2 ignition controller and natural gas valve with regulator all in one body, 3/4"	79888-N/A	³ N/A
54	J/C	G65BCM-1 ignition controller & natural gas valve w/regulator & lockout, 1 body, 1/2"	79808-N/A	³ N/A
55	J/C	G65BBM-3 ignition controller & natural gas valve w/regulator & lockout, 1 body, 1/2"	84570-N/A	³ N/A
56	J/C	G65BKM-2 ignition controller & natural gas valve w/regulator & lockout, 1 body, 3/4"	79900-N/A	³ N/A
57	J/C	G66BMG-1 ignition controller and natural gas valve with regulator and lockout all in one body, 1/2" - Special for export	N/A	³ N/A
58	M/H	Solid state flame safeguard, RA890F (flame rectification)	86972	To replace with HSI: New wiring diagram PLUS Kit P/N 146268 ; or kits with 200VA transformer, P/N 146318 (115V); P/N 146319 (208V, 240, 480, 575V)
		Solid state spark generator, Q624A1006 or Q624A1014	86974	
59	M/H	Solid state flame safeguard, RA890G (ultraviolet)	89409	
		Solid state spark generator, Q624A1006 or Q624A1014	86974	
60	M/H	Solid state flame safeguard, R7795B (flame rectification)	89407	
		Solid state spark generator, Q624A1006 or Q624A1014	86974	
61	M/H	Solid state flame safeguard, R7795A (ultraviolet)	89436	
		Solid state spark generator, Q624A1006 or Q624A1014	86974	

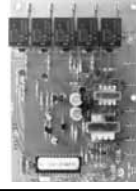
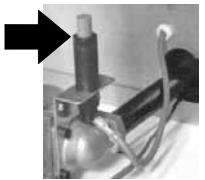
Code	Mfr	Description	P/N	Replaced by
62	J/C	Ignition controller G67BG-2, natural gas or propane on outdoor units only 	89314-N/A	Kit P/N 257472
63	J/C	Ignition controller G67NG-2, natural gas or propane on outdoor units only 	89488-N/A	Kit P/N 257473
64	M/H	Safety pilot for Bell Telephone, L62GB	N/A	N/A
65	J/C	Ignition controller G770NGC-4 with lockout, natural gas or propane 	97547-N/A	Kit P/N 257473 except for Model TR, use P/N 216970
66	J/C	Ignition controller G67BG-5, natural gas or propane on outdoor units only 	97782-N/A	Kit P/N 257472

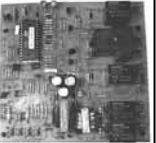





Code	Mfr	Description	P/N	Replaced by
67	RAM	Hot surface ignition module H4MC2 	121543	204376 (Code 82)
68	M/H	Piezo Ignitor Q635A1010 	125836	
69	M/H	Ignition controller GS4S6DD 	134780	
70	M/H	Ignition Controller S4560B1055-ML11149	145714	
71	RAM	Direct Spark Integrated Control Board 3MC4-03 	147102	Kit P/N 257531
72	RAM	Hot surface ignition module H4MC2 	157953	204376 (Code 82)



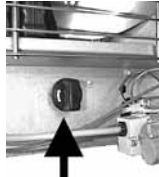



¹ F = Fenwall; G/C = General Controls; J/C = Johnson Controls; M/H = Honeywell; T = Thermodisc; W/R = White-Rodgers

² Functional replacement may require field-furnished wiring.

³ This item is no longer available. Suggest you contact the control manufacturer for replacement or functional replacement.

Safety Pilot or Ignition System Originally Supplied, Identified by Serial No. Code (cont'd) -- See Serial No. Decoding on pages 3-4. (N/A = Not available; see other notes below.)

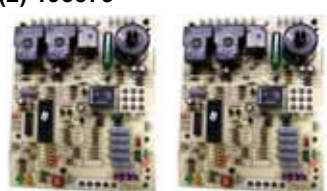









Code	Mfr	Description	P/N	Replaced by
73	RAM	Direct Spark integrated Control Board 3MC4-04	164326 	Kit P/N 258251
74	Channel Products	1691-06, Rotary Piezo Electric Ignitor (Used on Model UF for Ambirad.)	173036 	
75	J/C	Direct Spark Ignition Module, #G861KCC-5401D	174260 	Kit P/N 257531
76	RAM	Direct Spark Integrated Control Module 3MC4-06	178453 	Kit P/N 258251
77	J/C	Direct Spark Ignition Control Board, G822KCC-5401 D	193804 	Kit P/N 258251
78	UTC	Direct Spark Ignition with Cooling Relay, UTC #1097-211	195573 	
79	UTC	Direct Spark Ignition, UTC #1097-210	195265 	
80	UTC	Direct Spark Ignition Board, UTC #1016-426	204955 	





Code	Mfr	Description	P/N	Replaced by
81	Synetek	IH1104C Dual Flame Ignition Module	204166 	
82	Synetek	IH-11040B-C Single Flame Rod Ignition Module	204376 	
83	UTC	Direct Spark Ignition Module with Cooling Relay, #1097-211	214979 	
(Same as CODE 78 with DIP switch adjusted for a 45 second blower off delay)				
84	J/C	Intermittent Pilot Ignition Control with lockout and vent damper connections, G770NHC-1	234012-N/A 	Kit P/N 257473
85	UTC	#1097-211, Direct Spark Ignition with Cooling Relay	(2) 195573 	
86	Varidigm	VB4-H500 Combustion Board (RDCB/ RDCB H500)	223554-N/A 	Contact your Reznor® Representative or the factory for replacement information.
87	Varidigm	VB4-H600 Combustion Board (RDCB/ RDCB H600)	223555-N/A 	Contact your Reznor® Representative or the factory for replacement information.

¹ J/C = Johnson Controls; M/H = Honeywell; RAM = RAM Electronics

² Functional replacement may require field-furnished wiring.

Safety Pilot or Ignition System Originally Supplied, Identified by Serial No. Code (cont'd) -- See Serial No. Decoding on pages 3-4.

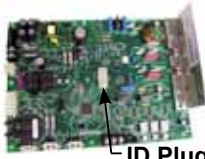
Code	Description	P/N(s)	Replaced by
88	Varidigm VB4-H700 Combustion Board (RDCB/ Rddb H700)	223556-N/A 	Contact your Reznor® Representative or the factory for replacement information.
89	Varidigm VB4-H800 Combustion Board (RDCB/ Rddb H800)	222678 - N/A 	Contact your Reznor® Representative or the factory for replacement information.
90	UTC #1097-211 Direct Spark Ignition and Varidigm VB4-H500 Combustion Board (RDCB/ Rddb H10C)	195573  223554 - N/A 	P/N 223554 is no longer available. Contact your Reznor® Representative or the factory for replacement information.
91	UTC #1097-211 Direct Spark Ignition and Varidigm VB4-H600 Combustion Board (RDCB/ Rddb H12C)	195573  223555 - N/A 	P/N 223555 is no longer available. Contact your Reznor® Representative or the factory for replacement information.
92	UTC #1097-211 Direct Spark Ignition and Varidigm VB4-H700 Combustion Board (RDCB/ Rddb H14C)	195573  223556 - N/A 	P/N 223556 is no longer available. Contact your Reznor® Representative or the factory for replacement information.
93	UTC #1097-211 Direct Spark Ignition and Varidigm VB4 Combustion Board (RDCB/ Rddb H16C)	195573  222678 - N/A 	P/N 222678 is no longer available. Contact your Reznor® Representative or the factory for replacement information.

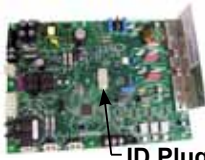
Code	Description	P/N	Replacement
94	UTC #1003-638-A Recycling Ignition Controller	257009 	
95	UTC #1003-514 Ignition Controller with Lockout	257010 	
96	Varidigm VB1200-5-RZNR-C	257246 	NOTE: If CODE 96 board is replaced, the ID plug must either be replaced also or removed and installed on the new board. See page 10 for a list of ID plugs.
97	Varidigm VB1200-5-RZNR-AB	258319 	NOTE: If CODE 97 board is replaced, the ID plug must either be replaced also or removed and installed on the new board. See page 10 for a list of ID plugs.
98	Varidigm VB1200-2-RZNR-PVA	260252 	NOTE: If CODE 98 board is replaced, the ID plug must either be replaced also or removed and installed on the new board. See page 10 for a list of ID plugs.
99	Varidigm VB1200-5-RZNR-SHH	260917 	NOTE: If CODE 99 board is replaced, the ID plug must either be replaced also or removed and installed on the new board. See page 10 for a list of ID plugs.

Ignition Systems

ID Plugs for Varidigm Deep Modulation Boards, Ignition CODES 96 and 97, on page 9

Miscellaneous Information

ID Plug P/N	ID Plug No.	ID Plug Label	Applies to				
			Model	Heat Section	Ignition CODE	Gas	
258113	13	MAPS A100NG	Models RDCB, RDDB, RDCC, & RDCC	100	97	Natural	
258114	14	MAPS A100LP		Propane			
258115	15	MAPS A150NG		150		Natural	
258116	16	MAPS A150LP		Propane			
258117	17	MAPS A200NG		200		Natural	
258118	18	MAPS A200LP		Propane			
258129	29	MAPS B250NG	Models RDCB, RDDB, RDCC, & RDCC	250	96	Natural	
258130	30	MAPS B250LP		Propane			
258131	31	MAPS B300NG		300		Natural	
258132	32	MAPS B300LP	Propane				
258133	33	MAPS C400NG	Models RDCB, RDDB, RDCC, & RDCC	400		96	Natural
258134	34	MAPS C500NG		500			Natural
258135	35	MAPS C600NG		600	Natural		
258136	36	MAPS C700NG		700	Natural		
258141		MAPS D500NG	Models RDCB & RDDB	500 & 1000	96	Natural	
258142		MAPS D600NG		600 & 1200		Natural	
258143		MAPS D700NG		700 & 1400		Natural	
258144		MAPS D800NG		800 & 1600		Natural	

ID Plugs for Varidigm Deep Modulation Board, Ignition CODE 98, on page 9

ID Plug P/N	ID Plug Label	Applies to Model RDH with Ignition CODE 98	
		Heat Section	Gas
258081	PREEVA 175NG	175	Natural
258082	PREEVA 175LP		Propane
258083	PREEVA 200NG	200	Natural
258084	PREEVA 200LP		Propane
258085	PREEVA 225NG	225	Natural
258086	PREEVA 225LP		Propane
258087	PREEVA 250NG	250	Natural
258088	PREEVA 250LP		Propane
258089	PREEVA 300NG	300	Natural
258090	PREEVA 300LP		Propane
258091	PREEVA 350NG	350	Natural
258092	PREEVA 350LP		Propane
258093	PREEVA 400NG	400	Natural
258094	PREEVA 400LP		Propane

ID Plugs for Varidigm Deep Modulation Board, Ignition CODE 99, on page 9

ID Plug P/N	ID Plug Label	Applies to Model RHH and Model SHH with Ignition CODE 99	
		Heat Section	Gas
258101	SHH 130NG	130	Natural
258102	SHH 130LP		Propane
258103	SHH 180NG	180	Natural
258104	SHH 180LP		Propane
258105	SHH 260NG	260	Natural
258106	SHH 260LP		Propane
258107	SHH 350NG	350	Natural
258108	SHH 350LP		Propane

Ignition Conversion Kits to Convert from Match-Lit Pilot to Spark Pilot for Models F and B

Model F or B	Gas	Kit Description	Kit P/N	Instructions
F/B 25-165	Natural	Spark-ignited, intermittent safety pilot without lockout (UTEC Model 1003-638A, P/N 257009)	100525	Form CP-F/B IGN, P/N 100550
F/B 200-250			100526	
F 300-400, B 300			100527	
B 400			102348	
F/B 25-165		Spark-ignited, intermittent safety pilot with lockout (UTEC Model 1003-514, P/N 2570010)	100528	
F/B 200-250			100529	
F 300-400, B 300			100530	
B 400			102349	
F/B 25-200	Propane	(NOTE: Controller includes terminal for connecting vent damper.)	100531	
F 250-400, B 250-300			100532	
B 400			102350	

Ignition Conversion Kits to Convert Pilot Systems to Updated Spark Pilot, Hot Surface, or Direct Spark Ignition System for Models listed

Ignition System being Replaced	Gas	Conversion Kit P/N (Type of Ignition Controller in the Kit)	Instructions (in the Kit)		Applies to Models
			Form	P/N	
Replaces Pilot Codes 62, 63, 65, 66, 84	Natural or Propane	257473 (Ignition Controller 257010)	CP-IGN CNTRL	134704	Indirect-fired models with Pilot Code 62, 63, 65, 66, or 84
		257472 (Ignition Controller 257009)			
Replaces Pilot Code 71 or 75		257531 (Ignition Controller 195265)	CP-DSI CNTRL	265905	FT, SFT, TRP
Spark - flame rectification or ultraviolet		146268, 146318, 146319 (HSI P/N 204376)	CP-RDF-HSI	146321	RDF with Pilot Code 58, 59, 60, or 61
Model CAUA with Pilot Code 76 or 77		258251 (Ignition Controller 195573)	CP-CAUA-IGN CNTRL	178435	CAUA with Pilot Code 76 or 77
Model TR with Spark Pilot Code 65 or 66		216970 (DSI P/N 204955)	CP-TR-IGN CNV	215975	TR/TR-H with Pilot code 65 or 66

Type of Valve Originally Supplied -- See Serial No. Decoding on pages 3-4.

A dash (-) in the serial number means that no electric valve was furnished. All valves are 24 volt unless noted otherwise.

See ALL notes on pages 19-22. N/A = Not Available. See illustrations on pages 23-27.

Serial No. Code	Original Valve on Heater	Valve Mfr ¹	Pipe Size	P/N	² Functional Replacement	
					Code	P/N
1	⁵ GF21G18 or 91F21G18	J/C	3/8	N/A	¹⁰	88242
2	⁵ GA4G18 or 91A4G18	J/C	1/2 (sm)	N/A	¹⁰	88242
3	⁵ GD4G18 or 91D4G18	J/C	1/2 (lg)	N/A	¹⁰	88242
4	⁵ GS5G18	J/C	3/4	N/A	¹⁰	88242
5	⁵ 2509-206	W/R	3/4	N/A	¹⁰	88242
6	⁵ 2509-207	W/R	3/4	N/A	¹⁰	88242
7	⁵ 2509-208	W/R	1	N/A	⁵	112922
8	⁵ V-80	M/H	1/2	N/A	¹⁰	88242
9	⁵ V-80	M/H	3/4	N/A	¹⁰	88242
01	⁵ NC1013-2T	M/N	1/2	N/A	¹⁰	88242
02	⁵ NC1014-2T	M/N	3/4	N/A	¹⁰	88242
03	⁵ NC1030-2E or NC1058-2T	M/N	1	N/A	⁵	112922
04	⁵ VA84A1004	M/H	1-1/4	N/A	⁵	112922
05	⁵ VA84A1012	M/H	1-1/2	N/A	⁵	112922
06	⁶ K3J41A102, 2 stage	G/C	1/2	N/A	X2	¹¹ 177396
07	⁶ K3J51A102, 2 stage	G/C	3/4	N/A	X3	¹¹ 177397
08	⁶ K3J61A102	G/C	1	N/A	³	
09	⁵ VA835	M/H	1/2	N/A	¹⁰	88242
10	⁵ VA835	M/H	3/4	N/A	¹⁰	88242
12	⁵ VA84	M/H	1	N/A	⁵	112922
13	⁵ 91S5G18	J/C	3/4	N/A	¹⁰	88242
14	⁵ 2509-204	W/R	1/2	N/A	¹⁰	88242
15	⁵ K3A	G/C	1-1/4	N/A	³	
16	⁵ V81A1060	M/H	1/2(sm)	N/A	¹⁰	88242
17	⁵ V81A1078	M/H	3/4(sm)	N/A	¹⁰	88242
18	⁵ 91A4G3	J/C	1/2(sm)	N/A	¹⁰	88242
19	⁵ 91D4G3 or H91EG-3	J/C	1/2(lg)	N/A	¹⁰	88242
20	⁷ B57 (Natural), single stage	G/C	1/2	N/A	K6 ¹²	96300
21	⁸ B57 (Propane), single stage	G/C	1/2	N/A	K9 ¹²	96303
22	⁵ V81D262	M/H	1	N/A	⁵	112922
23	⁵ 3601-228	W/R	1/2	N/A	¹⁰	88242
24	⁵ 3606-228 (Propane)	W/R	1/2	N/A	¹⁰	88242
25	⁵ NC1054-2E	M/N	3/4	N/A	⁵	112922
26	⁵ 1200AER	R	3/8x1/2	N/A	³	
27	⁹ 92D2204-A-1, 100% shutoff, 115V	J/C	1/2	N/A	³	
28	⁹ CS212-A2, 100% shutoff, 115V	J/C	1/2	N/A	³	
29	⁹ CS222A-1, 100% shutoff, 115V	J/C	1/2	N/A	³	
30	Direct Spark, 115V, V4225B100, Propane	M/H	1/2	N/A	³	
31	Direct Spark, 115V, V4224A1077, Natural	M/H	1/2	N/A	³	
33	⁷ B59R02-Natural or B59R109, single stage	G/C	1/2	N/A	K6 ¹²	96300
34	⁷ B59R06-Natural or B59R111, single stage	G/C	3/4	N/A	K7 ¹²	96301
35	⁸ B59A01-Propane or B59A15, single stage	G/C	1/2	N/A	K9 ¹²	96303
36	⁸ B59A05-Propane or B59A110, single stage	G/C	1/2	N/A	K9 ¹²	96303
37	⁵ V8257-A1244	M/H	1/2	N/A	¹⁰	88242
38	⁵ V829A-1001	M/H	1/2	N/A	¹⁰	88242
39	⁵ V81A-1359	M/H	3/4	N/A	⁵	112922
40	⁵ V88A-1345	M/H	1-1/2	N/A	³	
41	⁵ V81A-1086	M/H	1	N/A	⁵	112922
42	⁵ V829A-1001	M/H	3/4	N/A	¹⁰	88242
43	⁵ V8146A102	M/H	3/4	N/A	⁵	112922
44	⁵ V8146B-1023	M/H	3/4	N/A	⁵	112922
45	⁵ V88A13372	M/H	1	N/A	⁵	112922
46	¹³ NC1014-1E	M/N	3/4	N/A	³	
47	¹³ 92D4004A1	J/C	1/2	N/A	³	
48	⁵ V8202A	M/H	3/4	N/A	³	
49	⁵ 25A15-226 with plug for electric ignition	W/R	3/8	N/A	³	
50	⁵ 25046-404	W/R	1/2	N/A	³	
51	⁵ 92D4004G3	J/C	1/2	N/A	³	
52	⁵ K3A	G/C	1/2	N/A	⁵	112922
53	⁵ K3A	G/C	3/4	N/A	⁵	112922
54	⁵ K3A	G/C	1	N/A	⁵	112922
55	⁵ 25G10-204	W/R	1/2	N/A	¹⁰	88242
56	V48A2144 Diaphragm Type	M/H	1	N/A	³	
57	⁵ K40AC251	G/C	3/4	N/A	³	

(continued)

Type of Valve Originally Supplied (cont'd) -- See Serial No. Decoding on pages 3-4.

A dash (-) in the serial number means that no electric valve was furnished. All valves are 24 volt unless noted otherwise.

See ALL notes on pages 19-22. N/A = Not Available. See illustrations on pages 23-27.

Serial No. Code	Original Valve on Heater	Valve Mfr ¹	Pipe Size	P/N	² Functional Code	Replacement P/N
58	¹⁴ G52BAG-12 (Natural)	J/C	3/4	N/A	⁴	
59	¹⁴ G52DAG-13 (Natural) 2-stage (lg)	J/C	1/2	N/A	⁴	
60	⁵ K40AC361	G/C	1	N/A	³	
61	¹⁴ 96AGT-9	J/C	1/2	N/A	⁴	
62	963006-G	J/C	3/4	N/A	³	
63	¹⁴ G52BLG-12 (Propane)	J/C	3/4	N/A	⁴	
64	¹⁴ G52AAG-12 (Natural)	J/C	1	N/A	⁴	
65	¹⁵ G52AAY-1; DFT 250,260,290,325; Natural	J/C	1	N/A	³	
66	⁵ 2509-207	W/R	3/4	N/A	⁵	112922
67	⁵ 2509-208	W/R	1	N/A	⁵	112922
68	⁵ 2509-206 (Small)	W/R	3/4	N/A	¹⁰	88242
69	⁷ B590RA44 - Natural	G/C	3/4	N/A	K7 ¹²	96301
70	¹⁸ B590AA45 - Propane	G/C	3/4	N/A	⁴	
71	¹⁹ B59RJ155 - Natural	G/C	1/2	N/A	⁴	
72	¹⁹ B59RJ157 - Propane	G/C	3/4	N/A	⁴	
73	¹⁸ B59AJ156 - Propane	G/C	1/2	N/A	⁴	
74	¹⁸ B59RJ158 - Propane	G/C	3/4	N/A	⁴	
75	⁵ H91DG-3 Natural and Propane	J/C	1/2	N/A	¹⁰	88242
76	⁵ H91DG-3 Natural; H91DG-2 Propane	J/C	1/2	N/A	¹⁰	88242
77	⁵ NC1014-2T Natural	M/N	3/4	N/A	⁵	112922
	H91DG-2 Propane	M/N	1/2	N/A	¹⁰	88242
78	⁵ NC1014-2T Natural	M/N	3/4	N/A	⁵	112922
	H91EG-3 Propane	M/N	1/2	N/A	¹⁰	88242
79	⁵ NC1054-2T Natural	M/N	3/4	N/A	⁵	112922
	H91EG-2 Propane	M/N	1/2	N/A	¹⁰	88242
80	⁵ NC1054-2T	M/N	3/4	N/A	⁵	112922
	H91LG-1	M/N	3/4	N/A	¹⁰	88242
81	⁵ G95AGL-1 Natural - Model RHD	J/C	1/2	N/A	³	
82	⁵ G95GL-1 W/Kit Y71AA-4 Propane - Model RHD	J/C	1/2	N/A	³	
83	¹⁶ K72R13 Natural - side entrance 90° outlet valve, single stage	G/C	1/2	39298-N/A	K6 ¹²	96300
84	¹⁷ K72A14 Propane - side entrance 90° outlet valve, single stage	G/C	1/2	39299-N/A	G9	82396
85	¹⁸ G50AAY-1 Natural, 1-stage - DFT250 (includes built-in regulator)	J/C	1	N/A	³	
86	⁶ G52BLY-1, 2-stage, Propane, DFT 250, 260, 290, 325	J/C	3/4	N/A	³	
87	⁵ G50BLY-1, 1-stage, Propane, DFT250	J/C	3/4	N/A	³	
88	¹³ 1014-1E Natural, High Stage, DFT 300,400	M/N	3/4	N/A	³	
	¹³ 1013-1E Natural, Low Stage, DFT 300,400	M/N	1/2	N/A	³	
89	¹³ 1054-1E Natural, High Stage, DFT 500	M/N	3/4	N/A	³	
	¹³ 1013-1E Natural, Low Stage, DFT 500	M/N	1/2	N/A	³	
90	¹³ V48H-100-1, Natural, High Stage, DFT 600	M/N	3/4	N/A	³	
	¹³ 1013-1E Natural, Low Stage, DFT 600	M/N	1/2	N/A	³	
91	¹⁴ G52BAG-6, 2-stage, Natural, DFT 220	J/C	3/4	N/A	³	
92	¹⁴ G52AAG-6, 2-stage, Natural, DFT 285,340,395	J/C	1	N/A	³	
93	²³ G52BLG-10, 2-stage, Propane, DFT 285,340,395	J/C	3/4	N/A	³	
94	8215B30	J/C	3/4	N/A	³	
95	⁵ H91LG-1 91D4G-3	J/C	3/4	47537-N/A	¹⁰	88242
96	²² B59SJK171 Natural, 2 stage	G/C	1/2	N/A	X2 ²⁴	177396
97	²² B59BJK172 Propane, 2 stage	G/C	1/2	N/A	X1 ²⁴	177395
98	²² B59SJK163 Natural, 2 stage	G/C	3/4	N/A	X3 ²⁴	177397
99	²² B59BJK164 Propane, 2 stage	G/C	3/4	N/A	X1 ²⁴	177395
A1	²² B590SAK50 Natural, 2 stage	G/C	3/4	N/A	X3 ²⁴	177397
A2	²² B590BAK51 Propane, 2 stage	G/C	3/4	N/A	X1 ²⁴	177395
A3	¹³ SNC1054-1	M/N	3/4	N/A	³	
A4	⁷ 7000ERHC 455-501-501 Natural, single stage	R	3/4x1	N/A	K7 ¹²	96301
A5	²¹ 242NS 242-11121-1101 Natural, single stage	E	1/2	47380-N/A	Q2 ²⁵	121598
A6	²¹ 242NS 242-131121-1101 Natural, single stage	E	3/4	47381-N/A	9A	221525
A7	²¹ 242NSU 242-11120-2101 Propane, single stage	E	1/2	N/A	Q4 ²⁵	121600 ³⁶
A8	²¹ 242NSU 242-131120-2101 Propane, single stage	E	3/4	N/A	Q4 ²⁵	121600 ³⁶
A9	¹⁷ 7000GVER-HC Natural, single stage	R	3/4x1	N/A	9A	221525
B1	⁵ K3A441	G/C	1/2	N/A	¹⁰	88242
B2	⁵ K3A451	G/C	3/4	N/A	⁵	112922
B3	⁵ K3A461	G/C	1	N/A	⁵	112922
B4	G60QBG-7 with Controller - Natural	J/C	1/2	50448-N/A	³	
B5	H91MG Natural	J/C	1	47538-N/A	⁵	112922
B6	^{38, 7} 7000BER Natural 300-501-502, single stage	R	1/2	48577-N/A	K6 ¹²	96300
B7	⁷ 7000BER Natural 302-501-502A, single stage	R	3/4	N/A	K7 ¹²	96301

Type of Valve Originally Supplied (cont'd) -- See Serial No. Decoding on pages 3-4.

A dash (-) in the serial number means that no electric valve was furnished. All valves are 24 volt unless noted otherwise.

See ALL notes on pages 19-22. N/A = Not Available. See illustrations on pages 23-27.

Serial No. Code	Original Valve on Heater	Valve Mfr ¹	Pipe Size	P/N	² Functional Replacement	
					Code	P/N
B8	⁸ 7000BE Propane 300-505-501, single stage	R	1/2	N/A	K9 ¹²	96303
B9	⁸ 7000BE Propane 302-505-501, single stage	R	3/4	N/A	K9 ¹²	96303
C1	¹⁷ 7000BGVER Natural 312-501-503	R	1/2	N/A	³	
C2	¹⁷ 7000BGVER Natural 307-501-503	R	3/4	N/A	³	
C3	²⁸ 7000BGVE Propane 312-505-526	R	1/2	N/A	³	
C4	²⁸ 7000BGVE Propane 307-505-501	R	3/4	N/A	³	
C5	^{38,7} V800A1039 Natural, single stage	M/H	3/4	51299-N/A	K7 ¹²	96301
C6	⁸ G50DAG-1 Natural, single stage	J/C	3/4	N/A	¹²	
		Replacement for Standing Pilot		K7	96301	
		Replacement for Spark Pilot		9A	221525	
C7	²² V852A1097 Natural, 2-Stage	M/H	1/2	51357-N/A	X2 ^{12, 24}	177396
C8	²² V852A1071 Natural, 2-Stage	M/H	3/4	51358-N/A	X3 ^{12, 24}	177397
C9	²² V852A1105 Propane, 2-Stage	M/H	1/2	51359-N/A	X1 ^{12, 24}	177395
D1	²² V852A1089 Propane, 2-Stage	M/H	3/4	51360-N/A	X1 ^{12, 24}	177395
D2	²⁶ G60CPG-1 Propane w/separate lockout device	J/C	1/2	N/A	³	
	Y79 Lockout Device only, Y70BBA	J/C		46869-N/A		
D3	²⁶ G60QBG-7 Natural	J/C	1/2	N/A	³	
	Y79 Lockout Device only, Y70BBA	J/C		46869-N/A		
D4	²⁷ V850A1133 Natural, 2-Stage	M/H	3/4	52886-N/A	P8 ²⁰	115351
D5	²⁷ V850A117 Natural, 2-Stage	M/H	3/4	N/A	⁴	
D6	¹⁴ G52AAG-16 DFT units	J/C	1	N/A	³	
D7	^{38,7} 242 N-1 (Natural) 242-131131-1181, single stage	E	3/4	59341-N/A	K7 ¹²	96301
D8	²⁸ H91EG	J/C	1/2	N/A	³	
D9	³¹ H91EG	J/C	1/2	N/A	³	
E1	³⁰ B79B77RK34 Natural, 2-Stage	G/C	1/2	60609-N/A	X2 ¹²	177396
E2	³⁰ B79B77WK35 Natural, 2-Stage	G/C	3/4	60610-N/A	X3 ¹²	177397
E3	³⁰ B79B77WK36, Propane, 2-Stage	G/C	1/2	60611-N/A	X1 ¹²	177395
E4	²¹ SX242 242-131121-1214 Natural, single stage	E	3/4	61098-N/A	9A	221525
E5	²¹ SX242LS 242-111122-1215 Propane, single stg (also could be used on natural gas units equipped with Maxitrol controls)	E	1/2	61099-N/A	Q4 ²⁵	121600 ³⁶
E6	³² V4036B1019, 115V	M/H	1/2	N/A	³	
E7	³² V4036B1084, 240V	M/H	3/4	N/A	³	
E8	^{38,7} RS7000BER 300-502-719 Propane, single stg (also could be used on natural gas units equipped with Maxitrol controls)	R	1/2	62969-N/A	K9 ¹²	96303
E9	¹⁵ K72S32 Side Entrance Propane, single stage	G/C	1/2	64420-N/A	G9	82396
F1	³⁰ V850A1166 2-Stage, Natural	M/H	1/2	62966-N/A	P8	115351
F2	³⁰ V850A1158 2-Stage, Propane	M/H	1/2	62967-N/A	P9	115352
F3	VR852A1068 2-Stage, Propane	M/H	1/2	62946-N/A	X1 ¹²	177395
F4	G60QRH-1 Propane	J/C	1/2	56826-N/A	³	
F5	SX242LSH 242-131122-1248 Propane, single stg (also could be used on natural gas units equipped with Maxitrol controls)	E	3/4	63282-N/A	1B	221526
F6	²³ 36D05-201 Natural	W/R	1/2	62972-NA	³	
F7	²³ 36D05-401 Natural	W/R	3/4	62973-N/A	³	
F8	²³ 36D05-202 Propane	W/R	1/2	62974-NA	³	
F9 and G1	²⁹ G65BC Natural - Code F9	Valve Codes F9 and G1 indicate G65			³	
	²⁹ G65DCM-1 Propane - Code G1	ignition (Codes 50-56) and gas valve.			³	
G2	¹⁵ 7000BER 379-501-502 Side Entrance Natural	R	1/2	N/A	K6 ¹²	96300
G3	¹⁶ 7000BE 379-501-501 Side Entrance Propane	R	1/2	N/A	G9	82396
G4	⁷ 7000BER 403-501-729 Nat, single stage (no ECO cntr)	R	1/2	82196-N/A	K6 ¹²	96300
G5	⁷ 7000BER 403-502-719 Propane, single stg (also could be used on natural gas units equipped with Maxitrol system)	R	1/2	82197-N/A		221634
G6	⁷ 7000BER 408-501-502 Nat, single stg (with ECO cntr)	R	1/2	82198-N/A	K6 ¹²	96300
G7	⁷ 7000BER 408-502-719 Propane, Side Entrance, single stage (with ECO connector)	R	1/2	82199-N/A	G9	82396
G8	^{37,7} 36C03270 Natural, Side Entrance, single stg, w/ECO	W/R	1/2	82395-N/A	K6 ¹²	96300
G9	^{37,7} 36C03-433 Natural & Propane, Side Entrance, single stage, w/ECO	W/R	1/2	82396		
H1	^{38,7} V800A7028 Natural, single stage, w/ECO terminal	M/H	3/4	82398-N/A	K7 ¹²	96301
H2	^{38,7} 36C03-258 Natural, single stage, w/ECO terminal	W/R	1/2	82397-N/A	K6 ¹²	96300
H3	^{38,7} 700BER 403-501-832 Nat, single stg, w/ECO terminal	R	1/2	82624-N/A	K6 ¹²	96300
H4	⁷ 700BER 403-502-835 Pro, single stg, w/ECO terminal	R	1/2	82669-N/A	K9 ¹²	96303
H5	³⁰ 36D13-208 Natural, 2-Stage	W/R	1/2	87430	X2 ^{12, 39}	177396
H6	³⁰ 36D13-405 Natural, 2-Stage	W/R	3/4	87432	X3 ^{12, 39}	177397
H7	³⁰ 36D13-209 Propane, 2-Stage	W/R	1/2	87431	X1 ^{12, 39}	177395

(continued)

Type of Valve Originally Supplied (cont'd) -- See Serial No. Decoding on pages 3-4.

A dash (-) in the serial number means that no electric valve was furnished. All valves are 24 volt unless noted otherwise.

See ALL notes on pages 19-22. N/A = Not Available. See illustrations on pages 23-27.

Serial No. Code	Original Valve on Heater	Valve Mfr ¹	Pipe Size	P/N	Functional Replacement		
					Code	P/N	
H8	36D05-403 Propane	W/R	1/2x3/4	88243-N/A	³		
H9	VR8440C3031 Propane, single stage	M/H	1/2x3/4	93386-N/A	Q4	121600 ³⁶	
J1 (Two Valves)	⁵ (2) K3A562S, T, or U, or 2LB27BB6127, 115V	G/C, ASCO, or Skinner	1	86966 (2 required)			
J2	V5055A1004 Fluid Power, 115V	M/H	1	86992	W1 (alternate for J2; both Codes are approved)		
	V4055A1007 Actuator	M/H		86993			
J3 (Two Valves)	(2) V5055A1004 Fluid Power, 115V	M/H	1	86992 (2 required)	W1 (alternate for J2; both Codes are approved)		
	(2) V4055A1007 Actuator	M/H		86993 (2 required)			
J4 (Three Valves)	V5055A1004 Fluid Power, 115V	M/H	1	86992			
	V4055A1007 Actuator	M/H		86993			
	⁵ (2) K3A562S, T, or U, or 2LB27BB6127, 115V	G/C, ASCO, or Skinner		86966 (2 required)			
J5	¹⁷ DER7100 71P11A-000 Natural, single stage	R	1/2	89461-N/A	M4	96307	
J6	¹⁷ DER7100 71P11C-013 Propane, single stage	R	1/2	89462-N/A	M7	96310	
J7	¹⁷ VR8440A2092B Natural, single stage	M/H	1/2	89370-N/A	Q2	121598	
J8	¹⁷ 36C68-441 Natural, single stage	W/R	3/4	89397-N/A	9A	221525	
J9	¹⁷ VR8440A2100B Propane, single stage	M/H	1/2	89371-N/A	Q4	121600 ³⁶	
K1	¹⁷ 36C68-442 Pro, single stage (also could be used on natural gas units equipped with Maxitrol controls)	W/R	3/4	89398-N/A	1B	221526	
K2	V50551012 Fluid Power, 115V	M/H	1-1/4	89356	W3 (alternate for K2; both Codes are approved)		
	V4055A1007 Actuator	M/H		86993			
K3	FT8215C20, 115V (for Bell Telephone)	ASCO	1/2	N/A			
K4	V50551038 Fluid Power, 115V	M/H	2	91079	W4 (alternate for K4; both Codes are approved)		
	V4055A1007 Actuator	M/H		86993			
K5	V8200M7003, Natural, single stage	M/H	1/2	96299	9B	208920	
K6	36C03-211 Natural, single stage	W/R	1/2	96300			
K7	V800M7009 Natural, single stage	M/H	3/4	96301			
K8	V8200M7011 Propane, single stage	M/H	1/2	96302	1C	209412	
K9	V800M7017 Propane, single stage	M/H	3/4x3/4	96303			
M1	V850E7003 Natural, 2-stage	M/H	1/2	96304-N/A	P8 ⁴⁰	115351	
M2	V850E7029 Natural, 2-stage	M/H	3/4	96305-N/A	P8 ⁴⁰	115351	
M3	V850E7011 Propane, 2-stage	M/H	1/2x3/4	96306-N/A	P9 ⁴⁰	115352	
M4	VR8204M1000 Natural, single stage	M/H	1/2	96307			
M5	VR8440A2159 Natural, single stage	M/H	1/2	96308-N/A	Q3	121599	
M6	36C68-452 Natural, single stage	W/R	3/4	96309-N/A	Kit P/N 222037		
M7	VR8204M1018 Propane, single stage	M/H	1/2	96310			
M8	36C68-325 Pro, single stage (also could be used on natural gas units equipped with Maxitrol controls)	W/R	1/2x3/4	96311-NA	Kit P/N 221634		
M9	36D13-304 Propane, 2-stage	W/R	1/2x3/4	96312	X4 ^{12, 39}	177398	
N1	36D19-402 Natural, 50-90°F	W/R	3/4x3/4	100321-N/A	³⁴		
N2	36D19-403 Natural 90-130°F	W/R	3/4x3/4	100322-N/A	³		
N3	36D19-405 Propane, 50-90°F	W/R	3/4x3/4	100323-N/A	³⁴		
N4	36D19-406 Propane 90-130°F	W/R	3/4x3/4	100324-N/A	³		
N5 (Two Valves)	Mechanical modulation 50-90°F, Code N3, with bypass, Code M7, for Sizes 75-200						
	36D19-405 Propane	W/R	3/4x3/4	100323(N3)-N/A	³⁴		
	VR8204M1018 Propane, single stage	M/H	1/2	96310 (M7)			
N6 (Two Valves)	Mechanical modulation 50-90°F, Code N3, with bypass, Code M8, for Sizes 225-400						
	36D19-405 Propane	W/R	3/4x3/4	100323(N3)-N/A	³⁴		
	36C68-325 Propane, single stage	W/R	1/2x3/4	96311(M8)-N/A	Kit P/N 221634		
N7 (Two Valves)	AG13 Mechanical modulation 50-90°F, Code N1, with bypass, Code M4, for Sizes 75-150						
	36D19-402 Natural	W/R	3/4x3/4	1003213(N1)-N/A	³⁴		
	VR8204M1000 Natural, single stage	M/H	1/2	96307 (M4)			
N8 (Two Valves)	AG13 Mechanical modulation 50-90°F, Code N1, with bypass, Code M5, for Sizes 175-250						
	36D19-402 Natural	W/R	3/4x3/4	1003213(N1)-N/A	³⁴		
	VR8440A2159 Natural, single stage	M/H	1/2	96308-N/A	Q3	121599	
N9 (Two Valves)	AG13 Mechanical modulation 50-90°F, Code N1, w/bypass, Code M6, Sizes 300-400 and ADF/ADFH Nat & LP						
	36D19-402 Natural	W/R	3/4x3/4	100321(N1)-N/A	³⁴		
	36C68-452 Natural, single stage	W/R	3/4	96309-N/A	Kit P/N 222037		
O1&P1 ³³ (Two Valves)	AG14 Mechanical modulation 90-130°F, Code N2, with bypass, Code M4, for Sizes 75-150						
	36D19-403 Natural	W/R	3/4x3/4	100322-N/A	³		
	VR8204M1000 Natural, single stage	M/H	1/2	96307 (M4)			
O2&P2 ³³ (Two Valves)	AG14 Mechanical modulation 90-130°F, Code N2, with bypass, Code M5, for Sizes 175-250						
	36D19-403 Natural	W/R	3/4x3/4	100322-N/A	³		
	VR8440A2159 Natural, single stage	M/H	1/2	96308-N/A	Q3	121599	

Type of Valve Originally Supplied (cont'd) -- See Serial No. Decoding on pages 3-4.

A dash (-) in the serial number means that no electric valve was furnished. All valves are 24 volt unless noted otherwise.

See ALL notes on pages 19-22. N/A = Not Available. See illustrations on pages 23-27.

Serial No. Code	Original Valve on Heater	Valve Mfr ¹	Pipe Size	P/N	² Functional Replacement	
					Code	P/N
O3&P3 ³³ (Two Valves)	AG14 Mechanical modulation 90-130°F, Code N2, w/bypass, Code M6, Sizes 300-400 and ADF/ADFH Nat & LP					
	36D19-403 Natural	W/R	3/4x3/4	100322-N/A	³⁴	
	36C68-452 Natural, single stage	W/R	3/4	96309(M6)-N/A		Kit P/N 222037
O4&P4 ³³ (Two Valves)	AG14 Mechanical modulation 90-130°F, Code N4, with bypass, Code M7, for Sizes 75-200					
	36D19-406 Propane	W/R	3/4x3/4	100324-N/A	³	
	VR8204M1018 Propane, single stage	M/H	1/2	96310(M7)		
O5&P5 ³³ (Two Valves)	AG14 Mechanical modulation 90-130°F, Code N4, with bypass, Code M8, for Sizes 225-400					
	36D19-406 Propane	W/R	3/4x3/4	100324-N/A	³	
	36C68-325 Propane, single stage	W/R	1/2x3/4	96311(M8)-N/A		Kit P/N 221634
P6 (Two Valves)	Mechanical modulation 50-90°F, Code N1, with bypass, Code Q3, for Sizes 175-250					
	36D19-402 Natural	W/R	3/4x3/4	100321(N1)-N/A	³⁴	
	VR8304M2816 Natural, single stage	M/H	1/2	121599(Q3)		
P7 (Two Valves)	Mechanical modulation 90-130°F, Code N2, with bypass, Code Q3, for Sizes 175-250					
	36D19-403 Natural	W/R	3/4x3/4	100322-N/A	³	
	VR8304M2816 Natural, single stage	M/H	1/2	121599(Q3)		
P8	36C40-408 2-Stage, Natural (std pilot)	W/R	3/4	115351		
P9	36C41-408 2-Stage, Propane (std pilot)	W/R	3/4	115352		
Q2	VR8304M2808 Natural, single stage	M/H	1/2	121598		
Q3	VR8304M2816 Natural, single stage	M/H	1/2	121599		
Q4	VR8304H3802 Propane, single stage	M/H	1/2x3/4	121600		
Q5 (Two Valves)	Mechanical modulation 50-90°F, Code N1, with bypass, Code J8, for Sizes 300-400					
	36D19-402 Natural	W/R	3/4x3/4	100321(N1)-N/A	³⁴	
	36C68-441 Natural, single stage	W/R	3/4	89397(J8)-N/A	9A	221525
Q6 (Two Valves)	Mechanical modulation 90-130°F, Code N2, with bypass, Code J8, for Sizes 300-400					
	36D19-403 Natural	W/R	3/4x3/4	100322-N/A	³	
	36C68-441 Natural, single stage	W/R	3/4	89397(J8)-N/A	9A	221526
Q7 (Two Valves)	Mechanical modulation 50-90°F, Code N1, with bypass, Code Q2, for Sizes 75-250					
	36D19-402 Natural	W/R	3/4x3/4	100321(N1)-N/A	³⁴	
	VR8304M2808 Natural, single stage	M/H	1/2	121598 (Q2)		
Q8 (Two Valves)	Mechanical modulation 90-130°F, Code N2, with bypass, Code Q2, for Sizes 75-250					
	36D19-403 Natural	W/R	3/4x3/4	100322-N/A	³	
	VR8304M2808 Natural, single stage	M/H	1/2	121598 (Q2)		
Q9 (Two Valves)	Mechanical modulation 50-90°F, Code N3, with bypass, Code Q4, for Sizes 75-200					
	36D19-405 Propane	W/R	3/4x3/4	100323(N3)-N/A	³⁴	
	VR8304H3802 Propane, single stage	M/H	1/2x3/4	121600(Q4)		
R1 (Two Valves)	Mechanical modulation 90-130°F, Code N4, with bypass, Code Q4, for Sizes 225-400					
	36D19-406 Propane	W/R	3/4x3/4	100324-N/A	³	
	VR8304H3802 Propane, single stage	M/H	1/2x3/4	121600(Q4)		
R2	⁵ K3A651SF Natural & Propane	G/C	3/4	123604		
R3	⁵ K3A561-U Natural & Propane	ASCO	1	123603		
R4	⁵ K3A671SF Natural & Propane	G/C	1-1/4	123605		
R5	V4600A1023 Nat or V4600A1031 Nat/Pro	M/H	1/2	113766		
R6	V4400A10093	M/H	1/2	113767		
³⁵ R7	3B0-341-A04 or 3F1241A04 Natural, 50-100°F, Mod	R	3/4	131453		
³⁵ R8	5N7-341-A04 or 5R9241A04 Natural, 50-100°F, Mod	R	1	131455		
³⁵ R9	3B0-342-A05 or 3F1242A05 Propane, 50-100°F, Mod	R	3/4	131454		
³⁵ S1	5N7-342-A05 or 5R9242A05 Propane, 50-100°F, Mod	R	1	131456		
S2 (Two Valves)	3B0-341-A04 or 3F1241A04 Natural, 50-100°F, Mod	R	3/4	131453(R7)		
	36C68-325, Propane, single stage	W/R	1/2X3/4	96311(M8)-N/A		Kit P/N 221634
	5N7-341-A04 or 5R9241A04 Natural, 50-100°F, Mod	R	1	131455(R8)		
S3 (Two Valves)	36C68-442, Propane, single stage	W/R	3/4	89398(K1)-N/A	1B	221526
	3B0-342-A05 or 3F1242A05 Propane, 50-100°F, Mod	R	3/4	131454(R9)		
	36C68-325, Propane, single stage	W/R	1/2x3/4	96311(M8)-N/A		Kit P/N 221634
S5 (Two Valves)	5N7-342-A05 or 5R9242A05 Propane, 50-100°F, Mod	R	1	131456(S1)		
	36C68-442 Propane, single stage	W/R	3/4	89398(K1)-N/A	1B	221526
	Mechanical modulation 50-100°F, with bypass, Code Q2, for Sizes 75-225					
S6 (Three Valves)	3B0-341-A04 or 3F1241A04 Natural, 50-100°F	R	3/4	131453(R7)		
	36C68-325, Pro, single stage	W/R	1/2x3/4	96311(M8)-N/A		Kit P/N 221634
	VR8304M2808 Natural, single stage	M/H	1/2	121598(Q2)		
S7 (Three Valves)	Mechanical modulation 50-100°F, with bypass, Code J8, for Sizes 250-350					
	3B0-341-A04 or 3F1241A04 Natural, 50-100°F	R	3/4	131453(R7)		
	36C68-442, Pro, single stage	W/R	3/4	89398(K1)-N/A	1B	221526
	36C68-441 Natural, single stage	W/R	3/4	89397(J8)-N/A	9A	221525

(continued)

Type of Valve Originally Supplied (cont'd) -- See Serial No. Decoding on pages 3-4.

A dash (-) in the serial number means that no electric valve was furnished. All valves are 24 volt unless noted otherwise.

See ALL notes on pages 19-22. N/A = Not Available. See illustrations on pages 23-27.

Serial No. Code	Original Valve on Heater	Valve Mfr ¹	Pipe Size	P/N	² Functional Replacement	
					Code	P/N
Mechanical modulation 50-100°F, with bypass, Code Q4, for Sizes 75-225						
S8 (Three Valves)	3B0-342-A05 or 3F1242A05 Propane, 50-100°F	R	3/4	131454 (R9)		
	36C68-325 Propane, single stage	W/R	1/2x3/4	96311 (M8) - N/A	Kit P/N 221634	
	VR8304H3802 Propane, single stage	M/H	1/2x3/4	121600 (Q4)		
Mechanical modulation 50-100°F, with bypass, Code K1, for Sizes 250-400						
S9 (Three Valves)	3B0-342-A05 or 3F1242A05 Propane, 50-100°F	R	3/4	131454 (R9)		
	36C68-442, propane, single stage	W/R	3/4	89398 (K1) - N/A	1B	221526
	36C68-442, propane, single stage	W/R	3/4	89398 (K1) - N/A	1B	221526
Mechanical modulation 50-100°F, with bypass, Code M6, for ADF/ADFH Natural or Propane						
T1 (Three Valves)	5N7-341-A04 or 5R9241A04	R	1	131455 (R8)		
	36C68-442, propane, single stage	W/R	3/4	89398 (K1) - N/A	1B	221526
	36C68-452, natural, single stage	W/R	3/4	96309 (M6) - N/A	Kit P/N 222037	
T2	VR8304M4911 Natural	M/H	1/2	134358		
T3	VR8304M2824 Natural, single stage	M/H	1/2	136193		
T4	VR4601AA1010 Nat or VR4601AA1044B Nat/Pro	M/H	1/2	134778 - N/A		
T5	VR4601AB1000 Nat or VR4601AB1026 Nat/Pro	M/H	3/4	134779 - N/A		
T6	Maclaren GM7542-3043 Natural	J/C	1/2	142664		
T7	Modify Valve P/N 113766	M/H	1/2	144276		
T8	K3A661-T	G/C	1	146472		
T9	7222DER Natural, single stage	R	1/2	147133 - N/A	7E	260604
U1	7222DERLP Propane, single stage	R	1/2	147134 - N/A	8E	260606
U2	VR8205M1130 Natural, single stage	M/H	1/2	147830		
U3	VR8205M1148 Propane, single stage	M/H	1/2	147560 - N/A	8E	260606
U4	L821480 Natural	Asco	2	163136		
U5	L821440 Natural	Asco	3	163137		
U6	VR8305M4009, Natural, single stage	M/H	3/4	150839		
U7	VR8305M4017, Propane, single stage	M/H	3/4	150840		
U8	36C68-334, Propane, single stage	W/R	1/2x3/4	157167 - N/A	Kit P/N 221634	
U9	36C68-480, Propane, single stage	W/R	3/4x3/4	157168 - N/A	Kit P/N 221634	
V1	VR8405M5228, Natural & Propane, single stage	M/H	1	159743		
V2 (Two Valves)	(2) K3A651SF Natural & Propane	G/C	3/4	123604 (R2)		
V3 (Two Valves)	(2) K3A661-T Natural & Propane	ASCO	1	146472 (T8)		
V4 (Two Valves)	(2) K3A6715F Natural & Propane	ASCO	1-1/4	123605 (R4)		
V5 (Two Valves)	(2) L821480, 24V, Natural & Propane	ASCO	2	159736		
V6 (Two Valves)	(2) L82146OC Natural & Propane	ASCO	1-1/4	159731		
V7 (Two Valves)	(2) L821480C Natural & Propane	ASCO	2	159841		
V8 (Two Valves)	(2) L821440 Natural	ASCO	3	163137		
V9	#VR8305N4917 Propane, DSI, 2-stage	M/H	3/4x3/4	195737		
W1	Fluid Power Valve, V710FAS	ASCO	1x1	172667	J2 (W1 alternate for J2; both Codes are approved.)	
	Actuator, 120V, AH2B112A			172680		
W2 (Two Valves)	(2) Fluid Power Valve, V710FAS	ASCO	1x1	172667	J3 (W2 alternate for J3; both Codes are approved.)	
	(2) Actuator, 120V, AH2B112A			172680		
W3	Fluid Power Valve, V710GAS	ASCO	1-1/4x1-1/4	172678	K2 (alternate for W3; both codes are approved.)	
	Actuator, 120V, AH2B112A			172680		
W4	Fluid Power Valve, V710JAS	ASCO	2x2	172679	K4 (alternate for W4; both codes are approved.)	
	Actuator, 120V, AH2B112A			172680		
W5	VR8105M2817 Natural, single stage	M/H	1/2x1/2	172552 - N/A	U2	147830
W6	VR8105M2825 Propane, single stage	M/H	1/2x1/2	172553 - N/A	8E	260606
W7	VR8104M2505, Natural, single stage	M/H	1/2x1/2	170609		
W8	VR8204M1901, Natural, single stage	M/H	1/2x1/2	176680		
W9	VR8204H1907, Propane, single stage	M/H	1/2x1/2	176681 - N/A	Kit P/N 221093	
X1	VR8204Q2400, 2-Stage Propane	M/H	1/2	177395		
X2	VR8204Q2418, 2-Stage Natural	M/H	1/2	177396		
X3	VR8304Q4404, 2-Stage Natural	M/H	3/4	177397		
X4	VR8304Q4412, 2-Stage Propane	M/H	1/2x3/4	177398		
X5	VR8305Q4925, 2-Stage, Natural	M/H	3/4	195739		
X6	VR8300M3127, Natural, single stage	M/H	1/2x3/4	195740		
X7orZ3	VR8105K2942, Natural, single stage	M/H	1/2	196848 - N/A	6E	260603

Type of Valve Originally Supplied (cont'd) -- See Serial No. Decoding on pages 3-4.

A dash (-) in the serial number means that no electric valve was furnished. All valves are 24 volt unless noted otherwise.

See ALL notes on pages 19-22. N/A = Not Available. See illustrations on pages 23-27.

Serial No. Code	Original Valve on Heater	Valve Mfr ¹	Pipe Size	P/N	² Functional Replacement	
					Code	P/N
X8orZ4	VR8105N2949, Nat, 2-stage	M/H	1/2	196849 - N/A	Y8or4A	197066
X9orZ5	VR8105K2959, LP, single stage	M/H	1/2	196850 - N/A	9E	263999
Y1orZ6	VR8105N2931, LP, 2-stage	M/H	1/2	196851 - N/A	2A	197064
Y2orZ7	VR8205K2957, Natural, single stage	M/H	1/2	196980 - N/A	6E	⁴⁴ 260603
Y3orZ8	VR8305K4241, Natural, single stage	M/H	3/4	196981		
Y4orZ9	VR8205K2965, LP, single stage	M/H	1/2	196982 - N/A	9E	⁴⁴ 263999
Y5or1A	VR8305K4258, LP, single stage	M/H	3/4	196983		
Y6or2A	VR8205N2913, LP, 2-stage	M/H	1/2	197064		
Y7or3A	VR8305N4289, LP, 2-stage	M/H	3/4	197065		
Y8or4A	VR8205N2921, Natural, 2-stage	M/H	1/2	197066		
Y9or5A	VR8305N4297, Natural, 2-stage	M/H	3/4	197067		
Z1	2-STG VLV, LP, VR8205N2939	M/H	1/2	195736		
Z2	2-STG VLV, NAT, VR8205N2947	M/H	1/2	195738		
6A	VR8205M2955, Natural, single stage	M/H	1/2	204301		
7A	V8295A1031, 2PSI Natural & Propane	M/H	1	203860		
8A	V8295A1049, N & P	M/H	1-1/4	203861		
9A	36H32-441 Natural, single stage	W/R	3/4	221525		
1B	36H32-442 Propane, single stage	W/R	3/4	221526		
2B	V8944N-1053, 2-Stage, Natural	M/H	1	203866		
3B	V5155B-2548, Mech Mod Vlv 40-160°	M/H	1	203868-N/A	³	
4B	V5155A Mech Mod Vlv 40-120°	M/H	1	203869		
5B (Two Valves)	⁴¹ AG55, 3:1 Turndown with two 1-stage valves, natural gas, RDCA/RDDA w/Heat Section 200, 250, 300					
	VR8105K2942, Nat, single stage (Code X7 or Z3)	M/H	1/2	196848 (X7orZ3) - N/A	6E	260603
	VR8205K8905, Nat, single stage (Code Y2 or Z7)	M/H	1/2	196980 (Y2orZ7) - N/A	6E	260603
6B (Three Valves)	⁴² AG57, 6:1 Turndown w/two 1-stage valves & a modulating valve, nat gas, RDCA/RDDA w/Heat Section 100, 150					
	VR8105K2942, Nat, single stage (Code X7 or Z3)	M/H	1/2	(2)196848 (X7orZ3) - N/A	6E	(2) 260603
	MR410-1, Maxitrol Modulating Valve	Maxitrol	1/2	205582		
7B (Three Valves)	⁴² AG57, 6:1 Turndown w/two 1-stage valves & a modulating valve, nat gas, RDCA/RDDA with Heat Section 200					
	VR8105K2942, Nat, single stage (Code X7 or Z3)	M/H	1/2	196848 (X7orZ3) - N/A	6E	260603
	VR8205K8905, Nat, single stage (Code Y2 or Z7)	M/H	1/2	196980 (Y2orZ7) - N/A	6E	260603
	MR410-1, Maxitrol Modulating Valve	Maxitrol	1/2	205581		
8B (Three Valves)	² AG57, 6:1 Turndown w/two 1-stage valves & a modulating valve, nat gas, RDCA/RDDA w/Heat Section 250, 300					
	VR8105K2942, Nat, single stage (Code X7 or Z3)	M/H	1/2	96848 (X7orZ3) - N/A	6E	260603
	VR8205K8905, Nat, single stage (Code Y2 or Z7)	M/H	1/2	196980 (Y2orZ7) - N/A	6E	260603
	MR510, Maxitrol Modulating Valve	Maxitrol	1/2	205580		
9B	VR8200M7005, Natural, single stage, w/stnd pilot	M/H	1/2	208920		
1C	VR8200M7013, LP, single stage, w/stnd pilot	M/H	1/2	209412		
2C (Two Valves)	⁴¹ AG55, 3:1 Turndown with two 1-stage valves, natural gas, RDCA/RDDA with Heat Section 100, 150					
	VR8105K2942, Nat, single stage (Code X7 or Z3)	M/H	1/2	196848 (X7orZ3) - N/A	6E	260603
	VR8105K2942, Nat, single stage (Code X7 or Z3)	M/H	1/2	196848 (X7orZ3) - N/A	6E	260603
3C (Three Valves)	⁴¹ AG55, 3:1 Turndown w/three 1-stage valves, nat gas, RDCA/RDDA w/Heat Section 450, 500, 550, 600, 650, 700					
	(2) VR8305K4241, Nat, single stg (Code Y3 or Z8)	M/H	3/4	(2)196981 (Y3orZ8)		
	VR8205K8905, Nat, single stage (Code Y2 or Z7)	M/H	1/2	(1)196980 (Y2orZ7) - N/A	6E	260603
4C (Two Valves)	⁴¹ AG55, 3:1 Turndown w/two 1-stage valves, propane gas, RDCA/RDDA w/Heat Section 100, 150, 200, 250, 300					
	VR8105K2959, Pro, single stage (Code X9 or Z5)	M/H	1/2	196850 (X9orZ5) - N/A	9E	263999
	VR8105K2959, Pro, single stage (Code X9 or Z5)	M/H	1/2	196850 (X9orZ5) - N/A	9E	263999
5C (Two Valves)	⁴¹ AG55, 3:1 Turndown with two 1-stage valves, propane gas, RDCA/RDDA with Heat Section 350, 400					
	VR8105K2959, Pro, single stage (Code X9 or Z5)	M/H	1/2	196850 (X9orZ5) - N/A	9E	263999
	VR8305K4258, Pro, single stage (Y5 or 1A)	M/H	3/4	196983 (Y5or1A)		
6C (Three Valves)	⁴¹ AG55, 3:1 Turndown w/three 1-stage valves, propane gas, RDCA/RDDA w/Heat Sctn 450, 500, 550, 600, 650, 700					
	VR8105K2959, Pro, single stage (Code X9 or Z5)	M/H	1/2	196850 (X9orZ5) - N/A	9E	263999
	(2) VR8305K4258, Pro, single stg (Code Y5 or 1A)	M/H	3/4	(2)196983 (Y5or1A)		
7C (Three Valves)	² AG57, 6:1 Turndown w/two 1-stage valves & a modulating valve, nat gas, RDCA/RDDA w/Heat Section 350, 400					
	VR8305K4241, Nat, single stage (Code Y3 or Z8)	M/H	3/4	196981 (Y3orZ8)		
	VR8205K8905, Nat, single stage (Code Y2 or Z7)	M/H	1/2	196980 (Y2orZ7) - N/A	6E	260603
	MR610-1-66, Modulating Valve	Maxitrol	3/4	208370		
8C (Three Valves)	⁴² AG57, 6:1 Turndown w/3 1-stg valves & a modulating valve, nat gas, RDCA/RDDA w/Heat Sctn 450, 500, 550, 600, 650, 700					
	(2) VR8305K4241, Nat, single stg (Code Y3 or Z8)	M/H	3/4	(2)196981 (Y3orZ8)		
	VR8205K8905, Nat, single stage (Code Y2 or Z7)	M/H	1/2	196980 (Y2orZ7) - N/A	6E	260603
	MR610-1-88, Modulating Valve	Maxitrol	1	208371		
9C (Three Valves)	⁴¹ AG55, 3:1 Turndown with two 1-stage valves, natural gas, RDCA/RDDA with Heat Section 350, 400					
	VR8305K4241, Nat, single stage (Code Y3 or Z8)	M/H	3/4	196981 (Y3orZ8)		
	VR8205K8905, Nat, single stage (Code Y2 or Z7)	M/H	1/2	196980 (Y2orZ7) - N/A	6E	260603

(continued)

Type of Valve Originally Supplied (cont'd) -- See Serial No. Decoding on pages 3-4.

A dash (-) in the serial number means that no electric valve was furnished. All valves are 24 volt unless noted otherwise.

See ALL notes on pages 19-22. N/A = Not Available. See illustrations on pages 23-27.

Serial No. Code	Original Valve on Heater	Valve Mfr ¹	Pipe Size	P/N	² Functional Replacement	
					Code	P/N
1D	V5097C1000, Natural or Propane	M/H	3/4x2	203862		
2D	36H32-423, Natural, single stage	W/R	3/4x3/4	221633		
3D (Two Valves)	AG70, 8:1 Turndown w/dual 1-stg valve & actuated ball valve (nat gas only), RDCB/RDDB/RDCC/RDDC w/Ht Sctn 400, 500, 600, 700, 800					
	VR8405M5228 Natural, dual 1-stg (Code V1)	M/H	1	159743 (V1)		
	⁴³ ABV-1.0NN Ball Valve	RTC		222861		
4D (Three Valves)	AG70, 16:1 Turndown w/dual 1-stg valve & actuated ball valve (nat gas only), RDCB/RDDB w/Ht Sctn 1000, 1200, 1400, 1600					
	(2) VR8405M5228 Natural, dual 1-stg (Code V1)	M/H	1	159743 (V1)		
	⁴³ ABV-1.0NN Ball Valve	RTC		222861		
5D (Two Valves)	AG69, 2-stg gas control, RDCB/RDDB with Heat Section 500, 600, 700, 800					
	VR8405M5228 Natural, dual 1-stg (Code V1)	M/H	1	159743 (V1)		
	V8944N-1053, 2-Stage, Natural (Code 2B)	M/H	1	203866 (2B)		
6D (Four Valves)	AG69, 2-stg gas control, RDCB/RDDB with Heat Section 1000, 1200, 1400, 1600					
	(2) VR8405M5228 Natural, dual 1-stg (Code V1)	M/H	1	159743 (V1)		
	(2) V8944N-1053, 2-Stage, Natural (Code 2B)	M/H	1	203866 (2B)		
7D (Two Valves)	AG70, 8:1 Turndown with 1-stg valve & actuated ball valve (natural gas), RDCB/RDDB with Ht Sctn 250, 300					
	AG58 & D12G, 8:1 Turndown with 1-stg valve & actuated ball valve (natural gas), RDH Sizes 225, 225, 250, 300, 350, 400A and SHH Sizes 260 & 350					
	VR8305K4241, Nat, single stage (Code Y3 or Z8)	M/H	3/4	196981		⁴⁵ RDCB/RDDB replace w/150839 (U6)
8D (Two Valves)	AG70, 8:1 Turndown with 1-stg valve & actuated ball valve (propane), RDCB/RDDB with Ht Sctn 250, 300					
	AG58 & D12G, 6:1 Turndown with 1-stg valve & actuated ball valve (propane), RDH Sizes 225, 225, 250, 300, 350, 400A and SHH Sizes 260 & 350					
	VR8305K4258, LP, single stage (Code Y5 or 1A)	M/H	3/4	196983		⁴⁵ RDCB/RDDB replace w/150840 (U7)
9D (Two Valves)	AG70, 8:1 Turndown w/1-stg valve & actuated ball valve (natural gas), RDCB/RDDB w/Ht Sctn 100, 150, 200					
	AG58 & D12G, 8:1 Turndown w/1-stg valve & actuated ball valve (natural gas), RDH 175 & 200 and SHH 130 & 180					
	VR8205K8905, Nat, single stage (Code Y2 or Z7)	M/H	1/2	196980 - N/A		⁴⁵ RDCB/RDDB replace w/147830 (U2) ⁴⁴ RDH replace w/260603 (6E)
1E (Two Valves)	AG70, 8:1 Turndown w/1-stg valve & actuated ball valve (propane), RDCB/RDDB w/Ht Sctn 100, 150, 200					
	AG58 & D12G, 6:1 Turndown with 1-stg valve & actuated ball valve (propane), RDH 175 & 200 and SHH 130 & 180					
	VR8205K2965, LP, single stage (Y4orZ9)	M/H	1/2	196982 - N/A		⁴⁵ RDCB/RDDB replace w/260606 (8E) ⁴⁴ RDH replace w/263999 (9E)
2E (Two Valves)	AG70, 8:1 Turndown with 1-stg valve & actuated ball valve (natural gas), RDCB/RDDB/RDCC/RDDC with Ht Sctn 250, 300					
	VR8305M4009, Natural, single stage (U6)	M/H	3/4	150839 (U6)		
	⁴³ ABV-3.4NN Ball Valve	RTC		258321		
3E (Two Valves)	AG70, 8:1 Turndown with 1-stg valve & actuated ball valve (propane), RDCB/RDDB/RDCC/RDDC with Ht Sctn 250, 300					
	VR8305M4017, Propane, single stage (U7)	M/H	3/4	150840 (U7)		
	⁴³ ABV-3.4NN Ball Valve	RTC		258321		
4E (Two Valves)	AG70, 8:1 Turndown w/1-stg valve & actuated ball valve (natural gas), RDCB/RDDB/RDCC/RDDC w/Ht Sctn 100, 150, 200					
	VR8205M1130 Natural, single stage (U2)	M/H	1/2	147830		
	⁴³ ABV-1.2NN Ball Valve	RTC		255786		
5E (Two Valves)	AG70, 8:1 Turndown w/1-stg valve & actuated ball valve (propane), RDCB/RDDB/RDCC/RDDC w/Ht Sctn 100, 150, 200					
	VR8205M1148 Propane, single stage (U3)	M/H	1/2	147560	8E	260606
	⁴³ ABV-1.2NN Ball Valve	RTC		255786		
6E	VR8215T1239, Natural, single stage (slow opening)	MH	1/2	260603		
7E	VR8215S1263, Natural, single stage (std opening)	MH	1/2	260604		
8E	VR8215S5215, Propane, single stage (std opening)	MH	1/2	260606		
9E	VR8215T5214, Propane, single stage (slow opening)	MH	1/2	263999		

NOTES for pages 11-18, "Type of Valve Originally Supplied"

- ¹ G/C = General Controls; J/C = Johnson Controls; M/H = Minneapolis Honeywell; M/N = McQuay- Norris; R = Robertshaw; W/R = White-Rodgers
- ² Functional replacement may require field-furnished reducers and/or nipples. Replacement valves subject to change without notice.
- ³ This item is no longer available. Suggest you contact the control manufacturer for replacement or functional replacement.
- ⁴ Original no longer available. Contact Reznor[®] representative to determine availability of functional replacement. Provide complete Model No., type of gas, and type of pilot.
- ⁵ Single-stage solenoid valve.
- ⁶ Two-stage solenoid valve.
- ⁷ Combination valve consisting of automatic gas valve, pilot line filter, pressure regulator, pilot shutoff, manual shutoff, and safety pilot, all in one body.
- ⁸ Combination valve consisting of automatic gas valve, manual shutoff, pilot shutoff, and safety pilot, all in one body.
- ⁹ Same as ⁸ except 115 volts and less manual shutoff.
- ¹⁰ J/C #H91LG-8, 3/4", may require field supplied 3/4 x 1/2 bushings.
- ¹¹ When used as a functional replacement, this valve replaces valve and pressure regulator on unit and safety pilot.
- ¹² Requires male compression nut, **P/N 9664** (Baso #43283-2), for 1/4" pilot tubing connection (remove pilot tubing fitting supplied with valve). Some replacement applications require field-supplied 3/4x1/2 bushing and/or pipe nipple. If installed on Model (C)XL(B), (C)EEXL(B), or EEDU, a new bracket for assembling the valve and ignition controller is required; order **P/N 124019**.
- ¹³ Single-stage solenoid valve, 115 volt
- ¹⁴ Combination two-stage valve consisting of solenoid and regulator, all in one body.
- ¹⁵ Same as Note ¹⁴ , except 115 volt
- ¹⁶ Combination side entrance valve consisting of automatic gas valve, pilot line filter, pressure regulator, pilot shutoff, manual shutoff, safety pilot, all in one body.
- ¹⁷ Same as Note ¹⁶ except less regulator.
- ¹⁸ Combination valve consisting of automatic gas valve and manual shutoff, all in one body.
- ¹⁹ Combination valve consisting of automatic gas valve, pilot line filter, pressure regulator, pilot shutoff, and manual shutoff, all in one body, **less safety pilot**.
- ²⁰ For replacement of ECO adapter only on original valve, see page 26. The ECO adapter on the replacement valve is not field replaceable.
- ²¹ Combination valve consisting of automatic gas valve, pilot solenoid, pilot line filter, pressure regulator, pilot shutoff, manual shutoff, all in one body, less safety pilot.
- ²² Combination two-stage valve consisting of solenoid, regulator, pilot line filter, and manual shutoff, all in one body.
- ²³ Modulating redundant valve consisting of solenoid, regulator, and manual shutoff, all in one body, less safety pilot.
- ²⁴ Pilot line solenoid valve on original unit must be removed.
- ²⁵ If installed on a Model (C)XL(B), (C)EEXL(B), or EEDU, a new bracket for assembling the valve and ignition controller is required; order **P/N 124019**.
- ²⁶ Combination valve consisting of automatic gas valve, regulator, safety pilot or ignition controller, all in one body.
- ²⁷ Combination two-stage valve consisting of solenoid, regulator, pilot shutoff, manual shutoff, and safety pilot, all in one body.
- ²⁸ Special 1/2" H91EG drilled #42 used as low stage on XL30; also used as standard 1/2" H91EG as high stage.
- ²⁹ Combination valve consisting of automatic gas valve, regulator, safety pilot or ignition controller with lockout, all in one body.
- ³⁰ Combination two-stage valve consisting of solenoid, regulator, pilot valve, manual shutoff, all in one body.

(continued)

NOTES (cont'd) for pages 11-18, "Type of Valve Originally Supplied"

- ³¹ Special 1/2" H91EG valve drilled 1/8", used as low stage valve on Model XL60, also used a standard 1/2" H91EG as high stage.
- ³² Special valve furnished by Bell Telephone.
- ³³ Serial No. Codes O1, O2, O3, O4, and O5 apply to units manufactured from 5/90 to 12/90. Beginning with 1/91, these codes were changed to P1, P2, P3, P4 and P5.
- ³⁴ When the current inventory of this valve is depleted, a SINGLE mechanical modulation replacement valve WILL NO LONGER BE AVAILABLE.

WARNING: Do not replace an existing mechanical modulation valve with mechanical modulation valve Code R7, R8, R9, or S1 ONLY. To do so will result in an unsafe condition.

Replacement requires dual functional valves. A mechanical modulation valve plus either a solenoid valve or a single-stage valve depending on the application are required.

Field-furnished pipe nipples will be required to adapt the manifold for the two replacement valves. Install valves in series with single-stage or solenoid valve first and mechanical modulation valve second in the gas stream.

The chart below lists dual functional replacement valves by model/size/gas type combinations. Valves are available for most sizes. When functional replacement valves are not available from Thomas & Betts, contact valve manufacturer concerning availability of a functional replacement.

*Model Series	Sizes	Gas	Original Valve Code (see Serial No. on Furnace Rating Plate)	P/N's (and Codes) of Valves that can be used as Functional Replacements for the Mechanical Modulation Valve (two replacement valves are always required)
X/RX	75-350**	Natural	N1	P/N 131453 (R7) and solenoid valve, P/N 88242 (J/C #H91LG-8)
X/RX	400	Natural	N1	Replacement is not available.
X/RX	75-400	Propane	N3	P/N 131454 (R9) and solenoid valve, P/N 88242 (J/C #H91LG-8)
RG/RP/SSC	75-225	Natural	N1, N7, N8, P6, Q7	P/N 131453 (R7) and Replacement Kit P/N 221634
RG/RP/SSC	250-400	Natural	N1	P/N 131455 (R8) and Replacement Kit P/N 221526
RG/RP/SSC	250-350**	Natural	N8, N9, P6, Q5	P/N 131453 (R7) and Replacement Kit P/N 221526
RG/RP/SSC	400	Natural	N9, Q5	Replacement is not available.
RG/RP/SSC	75-225	Propane	N3, N5, N6, Q9	P/N 131454 (R9) and Replacement Kit P/N 221634
RG/RP/SSC	250-400	Propane	N3	P/N 131456 (S1) and Replacement Kit P/N 221526
RG/RP/SSC	250-400	Propane	N6	P/N 131454 (R9) and Replacement Kit P/N 221526
ADF/ADFH	300-1200	Natural or Propane	N1, N9	P/N 131455 (R8) and Replacement Kit P/N 221526

*Only duct furnace model identification of indirect-fired units appears here and on the rating plate. If the duct furnace is part of a Model XE, RGB, RPB, PAK, PGBL, RGBL, RPBL or SSCBL packaged furnace/blower system, valve replacement requirements are the same as for the component duct furnaces.

**On duct furnace Sizes 300 and 350, dual functional replacement valves require a minimum gas supply pressure of 7" w.c.

- ³⁵ Manifold arrangement also includes a single-stage solenoid valve, **P/N 88242**, J/C #H91LG-8.
- ³⁶ (H)(C)X(E) and (H)(C)RX(E) units mfgd prior to 11/86 must add lighter tube carry-over kit.
- ³⁷ Original valve includes an ECO adapter that is not field replaceable.
- ³⁸ For replacement of ECO adapter only, see page 26.
- ³⁹ Do not use replacement valve on units with G29 or G33 ignition controls
- ⁴⁰ ECO adapter on replacement valve is not field replaceable.
- ⁴¹ AG55, 3:1 gas control manifold illustrations identifying valves by their location.

Manifold Arrangement for Gas Control AG55 on Gas Heat Section Sizes 100-400

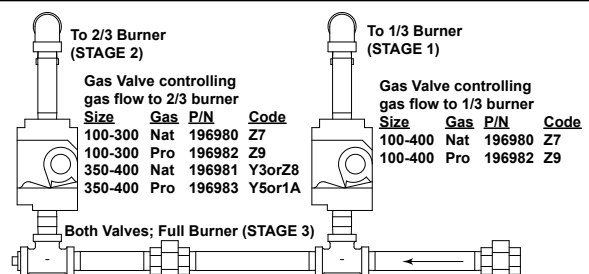

NOTES (cont'd) for pages 11-18, "Type of Valve Originally Supplied"

Manifold Arrangement for Gas Control AG55 on Gas Heat Section Sizes 450-700

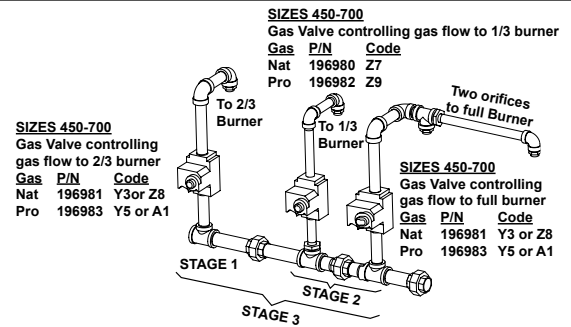

⁴² AG57, 6:1 modulating gas control manifold, illustrations identifying valves by their location.

Manifold Arrangement for Gas Control AG57 on Gas Heat Section Sizes 100-400

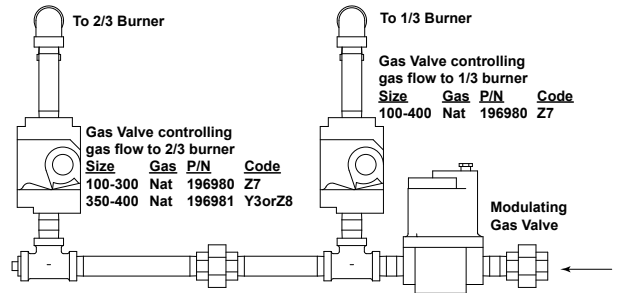

Manifold Arrangement for Gas Control AG57 on Gas Heat Section Sizes 450-700

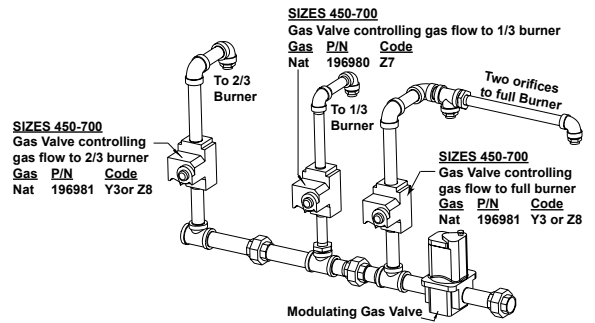

⁴³ Ball valve and actuator in deep modulation Gas Control Options AG70, AG58, and D12G.



See manifold illustrations and notes below.

AG70 Manifold in MAPS®III Models RCDB/ Rddb & MAPS®IV Models RCDC/RDDC with Heat Section Sizes 100, 150, and 200

NOTE: P/N 255786 is ball valve only; actuator is P/N 222862.

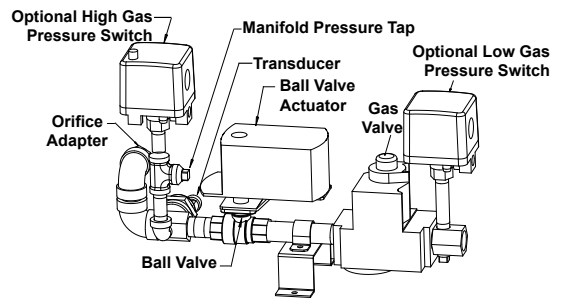

AG70 Manifold in MAPS®III Models RCDB/ Rddb & MAPS®IV Models RCDC/RDDC with Heat Section Sizes 250 and 300

NOTE: P/N 258321 is ball valve only; actuator is P/N 222862.

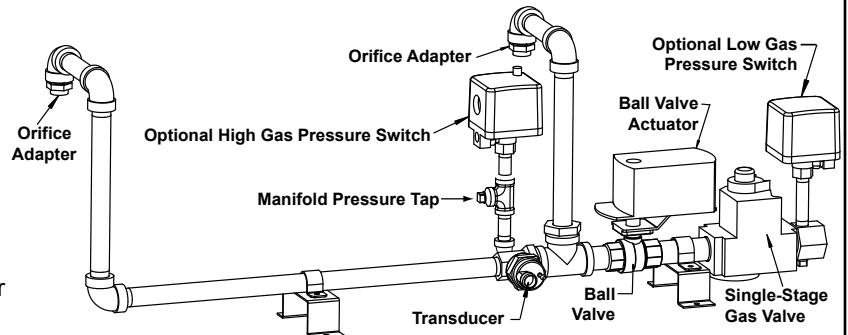

NOTES (cont'd) for pages 11-18, "Type of Valve Originally Supplied"

⁴³ NOTE 43 (cont'd) Ball valve and actuator in Gas Control Option AG70, AG58, and D12G.

AG70 Manifold in MAPS®III Models RCDB/Rddb & MAPS®IV Models RCDC/RDDC with Heat Section Sizes 400, 500, 600, 700

NOTE: P/N 222861 is the ball valve only; actuator is **P/N 222862**.

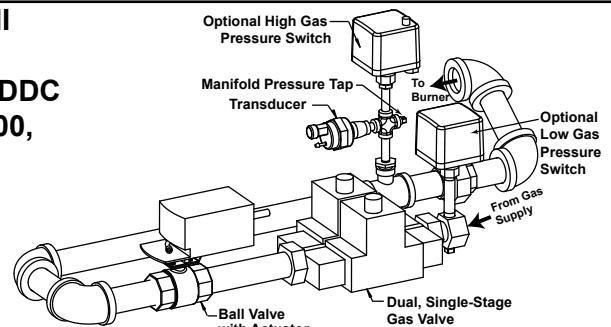

AG70 Manifold in MAPS®III D Cabinet Models RCDB/Rddb with Heat Section Sizes 500, 600, 700, 800, 1000, 1200, 1400, and 1600

NOTE: Manifold for single-stage burner applies only to Sizes 1000, 1200, 1400 and 1600. Sizes 500, 600, 700, and 800 have only the manifold for the modulating burner.

NOTE: P/N 222861 is the ball valve only; actuator is **P/N 222862**.

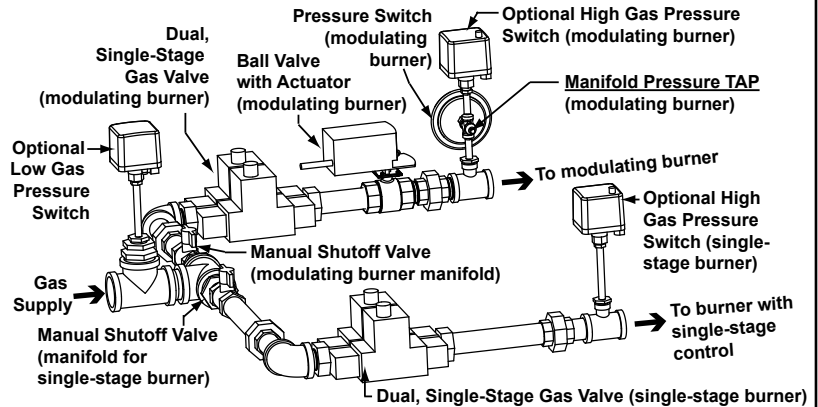

Manifold in Models RDH, SHH, and RHH with AG58 or D12G Gas Control

RDH Size	SHH and RHH Size	Gas	Ball Valve	Ball Valve Actuator
175 & 200	130 & 180	Nat	255786	222862
		Pro	255786	222862
225, 250, 300, 350, & 400	250 & 350	Nat	258321	222862
		Pro	258321	222862

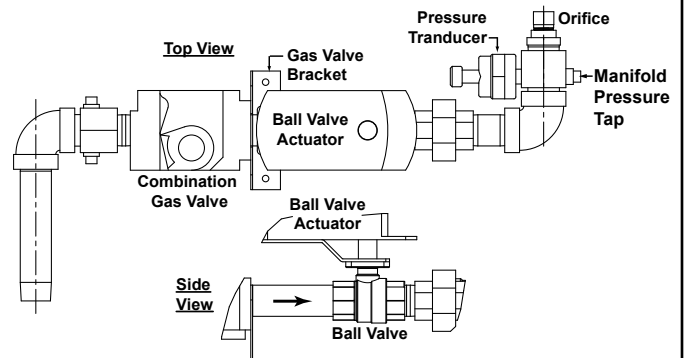

⁴⁴ NOTE 44: When installing this valve as a replacement for a valve with a different Serial No. Valve Code on a Model PDH, SDH, RDH, SHH, or RHH, a new valve bracket is required.

- For PDH, SDH, and RDH Sizes 75, 100, 125, and 150, order bracket P/N 261650.
- For PDH, SDH, and RDH Sizes 175 and 200, order bracket P/N 261249
- For SHH and RHH Size 130, order bracket P/N 261650.
- For SHH and RHH Size 180, order bracket P/N 261249.

⁴⁵ NOTE 45: As a result of continued product improvement, the valve that is factory installed on these Model RDCB/Rddb heat section sizes was changed from slow opening to standard opening effective 8/09. When replacing, the valve listed here is the appropriate functional replacement.

Replacement Valves (cont'd) - Identified by Third Element of the Serial No. (see pages 11-22). Valves showing "Replaced by P/N's" are no longer available from Thomas & Betts.



**Replacement
single-stage
Valve
P/N 96300**

See Serial No. Code	Size	Gas	P/N	Page	Replaced by:		
					Code	P/N	Page
83	1/2	N	39298	12	K6	96300	14
E9	1/2	P	64420	13	G9	82396	13



**Replacement
Valve
P/N 121598**

See Serial No. Code	Size	Gas	P/N	Page	Replaced by:		
					Code	P/N	Page
A5	1/2	N	47380	12	Q2	121598	15
A6	3/4	N	47381	12	9A	221525	17
E4	3/4	N	61098	13	9A	221525	17
E5	1/2	P	61099	13	Q4	121600	15
F5	3/4	P	63282	13	1B	221526	17
2D	3/4	N	221633	18			

For replacement of ECO adapter only, see page 26.



**Replacement
Valve
P/N 96301**

See Serial No. Code	Size	Gas	P/N	Page	Replaced by:		
					Code	P/N	Page
C5	3/4	N	51299	13	K7	*96301	14
D7	3/4	N	59341	13	K7	*96301	14
H1	3/4	N	82398	13	K7	*96301	14

*Replacement requires 1/4" pilot tubing connection, P/N 9664.



P/N 25787

See Serial No. Code	Size	Gas	P/N	Page	Replaced by:	
					P/N	Page
95	3/4	N or P	47537	12	88242	19, Note ¹⁰
B5	1	N or P	47538	12	112922	19, Note ⁵
Pilot Line Valve	1/4	N or P	25787			

**Replacement
Valve
P/N 96300**



For replacement of ECO adapter only, see page 26.

See Serial No. Code	Size	Gas	P/N	Page	Replaced by:		
					Code	P/N	Page
B6	1/2	N	48577	12	K6	*96300	14
E8	1/2	P	62969	13	K9	*96303	14
H3	1/2	N	82624	13	K6	*96300	14
H4	1/2	P	82669	13	K9	*96303	14

*Replacement requires 1/4" pilot tubing connection, P/N 9664.

For replacement of ECO adapter only for original valves, see page 26. The ECO adapter on the replacement valves is not field replaceable.



**Replacement
Valve
P/N 115351**

See Serial No. Code	Size	Gas	P/N	Page	Replaced by:		
					Code	P/N	Page
D4	3/4	N	52886	13	P8	115351	15
F1	1/2	N	62966	13	P8	115351	15
F2	1/2	P	62967	13	P9	115352	15



**Replacement
Valve
P/N 177396**

See Serial No. Code	Size	Gas	P/N	Page	Replaced by:		
					Code	P/N	Page
E1	1/2	N	60609	13	X2	177396*	16
E2	3/4	N	60610	13	X3	177397*	16
E3	1/2	P	60611	13	X1	177395*	16
F3	1/2	P	62946	13	X1	177395*	16

*Replacement requires 1/4" pilot tubing connection, P/N 9664.



**Replacement Valve
P/N 96300**

See Serial No. Code	Size	Gas	P/N	Page	Replaced by:		
					Code	P/N	Page
G8	1/2	N	82395	13	K6	96300	14
G9	1/2	P	82396	13			

Original valves include an ECO adapter that is not field replaceable.

Replacement Valves (cont'd) - Identified by Third Element of the Serial No. (see pages 11-22). Valves showing "Replaced by P/N's" are no longer available from Thomas & Betts.



**Replacement Valve
P/N 177396**

NOTE: Do not use on units with G29 or G33 ignition controls; order ignition kit P/N 49491.

See Serial No. Code	Size	Gas	P/N	Page	Replaced by:		
					Code	P/N	Page
H5	1/2	N	87430	13	X2	177396*	16
H6	3/4	N	87432	13	X3	177397*	16
H7	1/2	P	87431	13	X1	177395*	16
M9	1/2x3/4	P	96312	14	X4	177398*	16

*Replacement requires 1/4" pilot tubing connection, P/N 9664.

P/N 86966 may be a valve manufactured by either General Controls or Skinner (Skinner valve illustrated.)



See Serial No. Code	Size	Gas	P/N	Page
J1	1	N or P	(2) 86966	14



Fluid Power Valve



P/N 86993
Actuator (M/H V4055A1077) - Part of Serial No. Codes J2, J3, J4, K2, and K4

See Serial No. Code	Size	Gas	P/N	Page
J2, J3, J4	1	N or P	86992 (M/H #V5055A1004)	14
K2	1-1/4	N or P	89356 (M/H #V5055A1012)	14
K4	2	N or P	91079 (M/H #V5055A1038)	14

M/H fluid power valves above used with actuator, P/N 86993

W1, W2	1	N or P	172667 (ASCO V710FAS)	16
W3	1-1/4	N or P	172678 (ASCO V710GAS)	16
W4	2	N or P	179679 (ASCO V710JAS)	16

ASCO fluid power valves above used with actuator, P/N 172680



**Replacement Valve
P/N 96310**

See Serial No. Code	Size	Gas	P/N	Page	Replaced by:		
					Code	P/N	Page
J5	1/2	N	89461	14	M4	96307	14
J6	1/2	P	89462	14	M7	96310	14



Original valves include an ECO adapter that is not field replaceable.

**Replacement Valve
P/N 96300**

See Serial No. Code	Size	Gas	P/N	Page	Replaced by:		
					Code	P/N	Page
H2	1/2	N	82397	13	K6	*96300	14
K6	1/2	N	96300	14			

*Replacement requires 1/4" pilot tubing connection, P/N 9664.



**Replacement Valve
P/N 121599**

See Serial No. Code	Size	Gas	P/N	Page	Replaced by:		
					Code	P/N	Page
H9	3/4x1/2	P	93386	14	Q4	121600	15
J7	1/2	N	89370	14	Q2	121598	15
J9	3/4	P	89371	14	Q4	121600	15
M5	1/2	N	96308	14	Q3	121599	15



Replacement Valve P/N 221525

See Serial No. Code	Size	Gas	P/N	Page	Replaced by:		
					Code	P/N	Page
J8	3/4	N	89397	14	9A	221525	17
K1	3/4	P	89398	14	1B	221526	17
M6	3/4	N	96309	14	Kit P/N 222037		
M8	1/2x3/4	P	96311	14	Kit P/N 221634		
U8	1/2x3/4	P	157167	16	Kit P/N 221634		
U9	3/4x3/4	P	157168	16	Kit P/N 221634		



**Replacement Valve
P/N 208920**

See Serial No. Code	Size	Gas	P/N	Page	Replaced by:		
					Code	P/N	Page
K5	1/2	N	96299	14	9B	208920	17
K8	1/2	P	96302	14	1C	209412	17

Replacement Valves (cont'd) - Identified by Third Element of the Serial No. (see pages 11-22). Valves showing "Replaced by P/N's" are no longer available from Thomas & Betts.



P/N 96301

See Serial No. Code	Size	Gas	P/N	Page
K7	3/4	N	96301	14
K9	1/2x3/4	P	96303	14



Replacement Valve P/N 115351

See Serial No. Code	Size	Gas	P/N	Page	Replaced by:		
					Code	P/N	Page
M1	1/2	N	96304	14	P8	115351	15
M2	3/4	P	96305	14	P8	115351	15
M3	1/2x3/4	P	96306	14	P9	115352	15

(ECO adapter on replacement valves is not replaceable.)



P/N 96310

See Serial No. Code	Size	Gas	P/N	Page	Replaced by:		
					Code	P/N	Page
M4	1/2	N	96307	14			
M7	1/2	P	96310	14			
W8	1/2	N	176680	16			
W9	1/2	P	176681	16	Kit P/N	221093	

Mechanical Modulation Valve P/N 100321 - no longer available; for replacement instructions, see Note ³⁴ on page 20.



See Serial No. Code	Size	Gas	P/N	Page	Replaced by:		
					Code	P/N	Page
N1	3/4 x 3/4	N	100321	14	See Note ³⁴ on page 20.		
N2	3/4 x 3/4	N	100322	14	Not available		
N3	3/4 x 3/4	P	100323	14	See Note ³⁴ on page 20.		
N4	3/4 x 3/4	P	100324	14	Not available		



P/N 115351

See Serial No. Code	Size	Gas	P/N	Page
P8	3/4	N	115351	15
P9	3/4	P	115352	15



P/N 121599

See Serial No. Code	Size	Gas	P/N	Page
Q2	1/2	N	121598	15
Q3	1/2	N	121599	15
Q4	1/2x3/4	P	121600	15
T2	1/2	N	134358	16
T3	1/2	N	136193	16



P/N 123604

See Serial No. Code	Size	Gas	P/N	Page
R2 / V2	3/4	N & P	123604	15/16
R3	1	N & P	123603	15
R4 / V4	1-1/4	N & P	123605	15/16
T8 / V3	1	N & P	146472	16/16



P/N 113766

See Serial No. Code	Size	Gas	P/N	Page
R5	1/2	N	113766	15
Q3	1/2	N	113767	15
T7	1/2	N	144276	16



P/N 131453

See Serial No. Code	Size	Gas	P/N	Page
R7	3/4	N	131453	15
R8	1	N	131455	15
R9	3/4	P	131454	15
S1	1	P	131456	15

Manifold arrangement always includes either a solenoid valve or a single-stage redundant valve in series with these mechanical modulation (50-100°F) valves.

Replacement Valves (cont'd) - Identified by Third Element of the Serial No. (see pages 11-22).
Valves showing "Replaced by P/N's" are no longer available from Thomas & Betts.



**P/N
142664**

See Serial No. Code	Size	Gas	P/N	Page
T6	1/2	N	142664	16

P/N 147133



Replacement requires field-supplied piping.

**Replacement Valve,
P/N 260604**

See Serial No. Code	Size	Gas	P/N	Page	Replaced by:		
					Code	P/N	Page
T9	1/2	N	147133	16	7E	260604	18
U1	1/2	P	147134	16	8E	260606	18



**Replacement Valve
P/N 260603**

See Serial No. Code	Size	Gas	P/N	Pg	Replaced by:		
					Code	P/N	Pg
U2	1/2	N	147830	16			
U3	1/2	P	147560	16			
Y2orZ7	1/2	N	196980	17	6E	260603	18
Y4orZ9	1/2	P	196982	17	9E	263999	18
Y6or2A	1/2	P	197064	17			
Y8or4A	1/2	N	197066	17			
Z1	1/2	P	197536	17			
Z2	1/2	N	197538	17			
6A	1/2	N	204301	17			



**P/N
150839**

See Serial No. Code	Size	Gas	P/N	Pg
U6	3/4	N	150839	16
U7	3/4	P	150840	16
V9	3/4	P	195737	16
X5	3/4	N	195739	16
Y3orZ8	3/4	N	196981	17
Y5or1A	3/4	P	196983	17
Y7or3A	3/4	P	197065	17
Y9or5A	3/4	N	197067	17



P/N 159743

See Serial No. Code	Size	Gas	P/N	Pg
V1	1	N & P	159743	16



Replacement Valve P/N 260603

See Serial No. Code	Size	Gas	P/N	Pg	Replaced by:		
					Code	P/N	Pg
W5	1/2	N	172552	16	U2	147830	16
W6	1/2	P	172553	16	8E	260606	18
W7	1/2	N	170609	16			
X7orZ3	1/2	N	196848	16	6E	260603	18
X8orZ4	1/2	N	196849	17	Y8or4A	197066	17
X9orZ5	1/2	P	196848	17	9E	263999	18
Y1orZ6	1/2	P	196851	17	Y6or2A	197064	17



P/N 159736

See Serial No. Code	Size	Gas	P/N	Pg
V5	2	N&P	159736	16
V6	1-1/4	N&P	159731	16
V7	2	N&P	159841	16
V8	3	N&P	163137	16



**P/N
177396**

See Serial No. Code	Size	Gas	P/N	Pg
X1	1/2	P	177395	16
X2	1/2	N	177396	16
X3	3/4	N	177397	16
X4	1/2x3/4	P	177398	16



**P/N
195740**

See Serial No. Code	Size	Gas	P/N	Pg
X6	1/2x3/4	N	195740	16



P/N 203860

See Serial No. Code	Size	Gas	P/N	Pg
7A	1	N&P	203860	17
8A	1-1/4	N&P	203861	17

Replacement Valves (cont'd) - Identified by Third Element of the Serial No. (see pages 11-22). Valves showing "Replaced by P/N's" are no longer available from Thomas & Betts.



P/N 203866

See Serial No. Code	Size	Gas	P/N	Pg
2B	1	N	203866	17



P/N 203869

See Serial No. Code	Size	Gas	P/N	Page	Replaced by:		
					Code	P/N	Page
3B	1	N&P	203868	17	No longer available		
4B	1	N&P	203869	17			



P/N 208920

See Serial No. Code	Size	Gas	P/N	Page
9B	1/2	N	208920	17
1C	1/2	P	209412	17



P/N 203862

See Serial No. Code	Size	Gas	P/N	Page
1D	3/4x2	N or P	209412	18



P/N 221525

See Serial No. Code	Size	Gas	P/N	Page
9A	3/4	N	221525	17
1B	3/4	P	221526	17
2D	3/4	N	221633	18



P/N 260603

See Serial No. Code	Size	Gas	P/N	Page
6E	1/2	N	260603	18
7E	1/2	N	260604	18
8E	1/2	P	260606	18
9E	1/2	P	263999	18

Replacement ECO Adapters - The replacement adapters apply **only** to the valves listed; adapters **do not apply** to replacement valves.



P/N 82698,
M/H #39240-1

Valve P/N	Serial No. Code	Valve P/N	Serial No. Code	Valve P/N	Serial No. Code
52886	D4	96304	M1	82398	H1
62967	F2	96306	M3	96303	F9
96301	K7	62996	F1	96305	M2



P/N 82699,
R#21608

Valve P/N	Serial No. Code
82624	H3
82669	H4



P/N 113149,
M/H #39200-20

Valve P/N	Serial No. Code
96299	K5
96302	K8

Maxitrol Components for Electronic Modulation - Indirect-Fired Equipment Model Series X, SC, RG, RP, RX, RPV, and EEDU with Options AG7, AG8, AG9, AG21, AG39, AG40, AG41, or AG42

(References: For modulation control components for PREEVA Models PDH, SDH, and RDH, see replacement parts Form P-PRE-EVA. For MAPSII, see replacement parts Form P-MAPSII.)

Maxitrol Temperature Selectors/Thermostats, Temperature Sensors, and Amplifiers

Maxitrol System		20AH	30AH	21H	31H	21HR	31HR	Series 92	
Serial No. Suffix Code		MV-1	MV-2	MV-3	MV-5	MV-4	MV-6	MP-1	MP-3
Reznor® Model Series X, SC, RX, RPV, RG, RP, EEDU INDIRECT-Fired Furnaces with Option									
Components by Option		AG7		AG8		AG9		AG39	AG41
Number of Furnaces		Single Furnace	Multiple Furnaces	Single Furnace	Multiple Furnaces	Single Furnace	Multiple Furnaces	Single Furnace	Multiple Furnaces (Maxitrol components on 1st furnace only)
Temperature Selector	Reznor® P/N	--	--	On the Amplifier		48042	48042	174849	174849
	Maxitrol #					TD-121	TD-121	TD92-0509	TD92-0509
Selectrastat	Reznor® P/N	48033	48033	--	--	--	--	--	--
	Maxitrol #	T120	T120						
Optional Override Thermostat	Reznor® P/N	--	--	24857	24857	24857	24857	--	--
	Maxitrol #			T-115	T-115	T-115	T-115		
Sensor (P/N 48041 includes mixing tube)	Reznor® P/N	--	--	48041	48041	48041	48041	133228	133228
	Maxitrol #			TS-121	TS-121	TS-121	TS-121	TS194	TS194
Mixing Tube Only	Reznor® P/N	--	--	90323	90323	90323	90323	90323	90323
	Maxitrol #			MTI-12	MTI-12	MTI-12	MTI-12	MTI-12	MTI-12
Amplifier	Reznor® P/N	48035	48036	48037	48038	48035	48036	174848	174848
	Maxitrol #	A1010B	A1011B	A1010F	A1011F	A1010B	A1011B	A1092	A1092

P/N 48042, TD121 remotely located Temperature Selector used in Maxitrol 21HR and 31HR Systems, Option AG9 (box not included)



Selector with box, P/N 158465

Other Replacement Maxitrol Temperature Selectors (selector only; no box) - match selector with sensor:

#TD121A, **P/N 194258**
#TD121B, **P/N 194259**
#TD121F, **P/N 194260**

P/N 174849, Maxitrol TD92-0509, remotely located Temperature Selector used in Options AG39 & AG41



P/N 48033, T120 Thermostat used in Maxitrol 20AH and 30AH Systems, Option AG7



P/N 24857, T115 Overriding Thermostat used in Options AG8 and AG9

(Also used on Direct-Fired with Option AG31; see page 30.)



P/N 48041, TS12MT2-12 Duct Sensor used in Maxitrol 21H, 21HR, 31H and 31HR Systems, Option AG8 and AG9

(changed from 4x4 box to 2x4 box effective 5/89)



P/N 133228, Duct Sensor, Maxitrol TS194, used in Option AG39 and Option AG41



Other Replacement Maxitrol Discharge Air Sensors (sensor only, no box) - match with selector:

#TS121A, **P/N 194261**
#TS121B, **P/N 194262**
#TS121F, **P/N 194263**

Kit P/N 262320 replaces A1010B Amplifier, P/N 48035, used in Maxitrol 21HR (Option AG9) and 20AH (Option AG7) Systems and 1011F Amplifier, P/N 48036, in Maxitrol 30AH (Option AG7) and 31HR (Option AG9) Systems



Amplifier, Maxitrol A1010U, P/N 260863, in Replacement Kit P/N 262320

Kit P/N 262321 replaces A1010F Amplifier, P/N 48037, used in Maxitrol 21H (Option AG8) Systems and A1011F Amplifier, P/N 48038, used in Maxitrol 31H (Option AG8) Systems



Amplifier, Maxitrol AD1010U, P/N 260864, in Replacement Kit P/N 262321

P/N 174848, Maxitrol 1092
 Amplifier used in Option AG39
 and Option AG41 (Support
 Bracket, P/N **104155**)



Regulator used on **INDIRECT-FIRED** Reznor® Model Series X, SC, RG, RP, RX, RPV, and EEDU and gas heat sections in Models RCDA/RDDA equipped with Optional Electronic Modulation Options AG7, AG8, AG9, AG21, AG39, AG40, AG41, AG42, AG57



P/N	Maxitrol	Size	Thermocore Model Size	with Opt AG	Gas
42278	MR410	1/2"	75-125	7, 8, 9, 21	Natural
42279	MR510	1/2"	150-200	7, 8, 9, 21	Natural
42280	MR510	3/4"	225-400	7, 8, 9, 21	Natural
156462	MR410H-1	1/2"	75-125	7, 8, 9, 21	Propane
156463	MR510H-1	1/2"	150-200	7, 8, 9, 21	Propane
156464	MR510-H	3/4"	225-400	7, 8, 9, 21	Propane
174815	M420R, 20.0 MBH @3.8" w.c. inlet	1/2"	100	39, 40	Natural
174816	M420R, 25.0 MBH @3.9" w.c. inlet	1/2"	125	39, 40	Natural
174838	M520R, 40.3 MBH @ 3.7" w.c. inlet	1/2"	150-175	39, 40	Natural
174839	M520R, 51.8 MBH @ 3.9" w.c. inlet	1/2"	200-225	39, 40	Natural
174840	M520R, 69.0 MBH @ 4.0" w.c. inlet	3/4"	250-300	39, 40, 41, 42	Natural
174841	M520R, 100 MBH @ 4.4" w.c. inlet	3/4"	400	39, 40, 41, 42	Natural
P/N	Maxitrol	Size	RCDA/RDDA	with Opt AG	Gas
205582	MR410@120cfh	1/2"	100, 150	57	Natural
205581	MR410-1	1/2"	200	57	Natural
205580	MR510	1/2"	250, 300	57	Natural
208370	MR610-166	3/4"	350, 400	57	Natural
208371	MR610-1-88	1"	450, 500, 550	57	Natural

Maxitrol Signal Conditioner used on Both Indirect Fired Equipment and Direct Fired Equipment

P/N 134170, Maxitrol Signal Conditioner used in
Indirect Fired Gas Control

- Option AG21 (Serial No. Suffix Code MVA)
- Option AG40 (Serial No. Suffix Code MP2)
- Option AG42 (Serial No. Suffix Code MP4)
- Option AG44 (Serial No. Suffix Code MP6)
- Option AG57
- Option DG2
- Option DG6

Direct Fired Gas Control

- Option AG37 (Serial No. Suffix Code MVC)







When used in Options AG 21, 37, 40, 42, and 44, the signal conditioner (either Maxitrol A200 or Maxitrol Model SC10C-B6S1 or SC11-A, depending on date of manufacture) is activated by a customer-supplied input signal (either 4-20 milliamps or 0-10 volt).

Maxitrol Components for Electronic Modulation - Direct-Fired Equipment Model Series ADF, DV, and RDF with Options AG30, AG31, AG32, AG35, AG33, AG36, AG37, AG47, AG48, AG51

Maxitrol System		14	14	14A	14B	14E	
Serial No. Suffix Code		MV-7	MV-7	MV-8	MV-8	MV-D	
Reznor® Model Series ADF, DV, and RDF DIRECT-Fired Furnaces with Option							
Components by Option		AG30	AG31	AG32	AG35	AG47	
Temperature Selector	Reznor® P/N	86988	U.S. - 86988; Canada - 101165	87107	123943, 140°F Stop 159285, 160°F Stop	204455	
	Maxitrol #	TD114	TD114	TD114A	TD114B	TDFM14	
Override Thermostat (illustrated on page 23)	Reznor® P/N	--	24857	--	--	--	
	Maxitrol #	--	T-115	--	--	--	
Sensor	Reznor® P/N	90324	90324	87106	123944	Outside & Return Air (2) 204452	Discharge Air 204453
	Maxitrol #	TS-114	TS-114	TS-114A	TS-114B	TS394-2B-4	TS194Q
Mixing Tube	Reznor® P/N	90323	90323	90323	90323	(3) 90323	
	Maxitrol #	MTI-12	MTI-12	MTI-12	MTI-12	MTI-12	
Amplifier	Reznor® P/N	148590*	148590*	148590*	148590*	204454	
	Maxitrol #	A1014R	A1014R	A1014R	A1014R	ADFM14	

Maxitrol System		44		44E-21		44ER-21		94	
Serial No. Suffix Code		MV-9		MV-E		MV-F		MV-B	
Reznor® Model Series ADF, DV, and RDF DIRECT-Fired Furnaces with Option									
Components by Option		AG33		AG48		AG51		AG36	
Temperature Selector	Reznor® P/N	86990		204451		204451		133230, 120°F	159287, 160°F
	Maxitrol #	T244, Selectrastat		TDFM44		TDFM44		TD294E-609-0818	
Sensor	Reznor® P/N	119617 (max 120°F)	194160 (max 140°F)	Outside & Return Air (2) 204452	Discharge 204453	Outside & Return Air (2) 204452	Discharge 204453	133228	
	Maxitrol #	TS-144E	TS-144C	TS394-2B-4	TS194Q	TS394-2B-4	TS194Q	TS194	
Remote Sensor	Reznor® P/N	--	--	--	--	204456		--	--
	Maxitrol #	--	--	--	--	TSDM44		--	--
Mixing Tube	Reznor® P/N	90323		(3) 90323		(3) 90323		90323	
	Maxitrol #	MTI-12		MTI-12		MTI-12		MTI-12	
Amplifier	Reznor® P/N	268274**	268274**	204450		204450		133229	
	Maxitrol #	A1044U	A1044U	ADFM44		ADFM44		A1494	

Maxitrol Amplifiers used on Reznor® Direct-Fired Model Series ADF, DV, and RDF

 <p>P/N 148590, Model A1014R Amplifier used in Options AG 30, 31, 32, 35 * To replace P/N 148590, Model A1014L or A1014U or P/N 86976, order Replacement Kit P/N 268301.</p>	 <p>P/N 268274, Model A1044U, used in Option AG33 ** To replace P/N 194159 (A1044CL); P/N 157915 (A1044EL); P/N 119616 (A1044E) and P/N 86989 (A1044), order Replacement Kit P/N 268302.</p> <p>NOTE: Shown with cover removed.</p>	
 <p>P/N 204454, ADFM14 Amplifier</p>	 <p>P/N 204450, ADFM44 Amplifier</p>	 <p>P/N 133229, A1494 Amplifier, for Paint Booth Application, Option AG36</p>

Maxitrol Components for Electronic Modulation - Direct-Fired Equipment Model Series ADF, DV, and RDF with Options AG30, AG31, AG32, AG35, AG33, AG36, AG37, AG47, AG48, AG51 (cont'd)

Regulators used on DIRECT FIRED
Units are determined by BM Option and Manifold Size

P/N 123916,
M611-R66, 3/4";
P/N 87001,
M611-R88, 1"



P/N 89351, MR212D, 1-1/4";
P/N 91071, MR212E, 2";
P/N 163143, MR212G, 3"



Temperature Selectors (see table, page 30, for option application)



P/N 86988, TD114 U.S. Models, Range 55-90°F (selector with box, **P/N 156085**);
P/N 101165, TD114, Canadian Models, Range 50-75°F;
P/N 87107, TD114A, Range 80-130°F;
P/N 123943, TD114B, Range 120-140°F
P/N 159285, TD114B, Range 120-160°F
P/N 204455, TD DFM14
P/N 204451, TD DFM44



P/N 133230,
#TD294E-609-0818,
Dual Temperature
Selector for Paint
Booth Application,
Option AG36

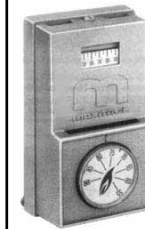

P/N 86990,
T244
Selectrastat,
Option AG33

Temperature Sensor (see table, page 30, for option application):



P/N 90324, TS114, Range 55-90°F;
P/N 87106, TS114-A, Range 80-130°F;
P/N 123944, TS114B, Range 80-140°F;
P/N 204452, TS394-2B-4;
P/N 204453, TS194Q;
P/N 119617, TS144E, Range 20-60°F and 60-120°F;
P/N 194160, TS144C, Range 20-60°F and 80-140°F;
P/N 87041, TS144, Range 40-80°F and 80-140°F;
P/N 133228 TS194 for Paint Booth Application

IMPORTANT NOTES: When replacing a temperature sensor on a Maxitrol MV-9 system (Option AG33), check the Model No. on the sensor. P/N 119617 or 194160 is used on units manufactured beginning 2/92; P/N 87041 is used on units manufactured prior to 2/92.

Sensors are not interchangeable; the sensor must match the amplifier shown on page 30.

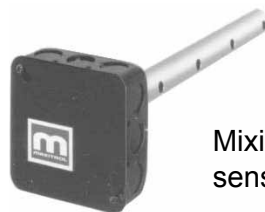

Mixing Tube for temperature
sensors, **P/N 90323,** MTI-12

Index

D

Date of Manufacture 4

E

ECO Adapters 27

I

ID Plugs 10

Ignition Conversion Kits 10

Ignition System 6

Instructions 2

M

AG70 Manifold in a MAPS III & IV 22

Manifold Arrangement for Gas Control AG55 20

Manifold Arrangement for Gas Control AG57 21

Maxitrol Components for Electronic Modulation 28, 30

Model No. Decoding 5

N

NOTES for Third Element of the Serial Number (Valves) 19, 20, 21, 22

P

PREFIX and SUFFIX Codes 5

R

Rating Plate 3

S

Safety Pilot 6

SAFETY WARNINGS 1

Serial No. 5

Decoding a MAPS® Unit Serial No. 4

Serial No. Decoding 3

Signal Conditioner 29

SUFFIX Codes 5

V

Valve Originally Supplied 11

Replacement Valves 23, 24, 25, 26, 27

www.RezSpec.com

(800) 695-1901

©2012 Thomas & Betts Corporation, All rights reserved.

Trademark Notes: Reznor®, MAPS®, and PREEVA® are registered in at least the United States. All other trademarks are the property of their respective owners.

06/12 Form P-VALVES (Version E)