

Control-R™

Connect for smarter hot water.

Control-R™ Wi-Fi Module Installation Manual



FOR YOUR RECORDS

If you have support questions, please call Customer Care and have your Control-R™ Wi-Fi module's AYL A ID and Water Heater Serial Number available.

AYLA ID: _____

(Located on back of Control-R™ Wi-Fi Module)

Water Heater Serial Number: _____

(Located on side of water heater)

TABLE OF CONTENTS

Thank You for Your Purchase	3
About the Control-R™ Wi-Fi Module	4
Specifications	5
Unpack System Contents	6
Select Module Location	7
Install Module	7
Mount the Module to a Wall	8
Connect Module to Water Heater	9
Connect to a Wi-Fi Network	10
Connect to Wi-Fi on Apple® Devices	11
Connect to Wi-Fi on Android® Devices	19
LED Color Codes	26
Troubleshooting	27
Pairing Instructions	28
Notes	29

Thank You for Your Purchase

Thank you for purchasing the Rinnai® Control-R™ Wi-Fi Module (referred to as **module** throughout this manual). Before installing and operating the module, be sure to read these instructions to familiarize yourself with the module's features and functionality.

If You Need Service

Please call Rinnai Customer Care at 1-800-621-9419 Monday to Friday between 8 AM to 8 PM EST. Please have the following information available:

- AYLA ID (Located on back of Control-R™ Wi-Fi Module)
- Water Heater Serial Number (Located on side of water heater)

FCC Part 15

This device complies with Part 15 of the FCC rules. Operation is subject to the following two conditions:

- This device may not cause harmful interference
- This device must accept any interference received, including interference that may cause undesired operation

Please Read and Save This Manual for Future Reference

About the Control-R™ Wi-Fi Module

With Rinnai's Control-R™ Wi-Fi Module, new and existing Rinnai Residential and Commercial Tankless Water Heaters (2006 and newer) can be remotely monitored and controlled via smart devices. Rinnai now has the capability to provide a new option for management, control and maintenance of Rinnai Tankless Water Heaters.

Control and Monitoring

Control the Rinnai Tankless Water Heater from a smart phone or tablet to turn the system on/off, change the water temperature and monitor status.

Remote Diagnostics and Maintenance

Gives technicians detailed system information via automatic alerts and remote diagnostic tools before ever leaving their place of business, leading to shorter maintenance and repair times.

Accessibility and Convenience

Get instant access to technical bulletins, product warranty, product registration, manuals, step-by-step repair guides and more!

The Control-R™ Wi-Fi Module attaches easily to the Rinnai Tankless Water Heater by a two wire interface quickly connecting through the local Wi-Fi network. Once connected and the free Rinnai App is downloaded, the Rinnai Tankless Water Heater can be associated to the Rinnai independent dealer.



Specifications

- Part Number: RWM101
- Works with all Rinnai Tankless Water Heater models manufactured 2006 and later (except the RH180 Hybrid Tank-Tankless Water Heater).
Note: The Lime Condition (LC) notification will not appear in the Rinnai App when the module is paired with the following series of Rinnai tankless water heaters manufactured prior to 2009: VA, VB, KA and V53e.
- Attaches to the side of the water heater via the magnetic enclosure (indoor models only) or mounts to an indoor wall with supplied mounting hardware.
- The module must be mounted indoors.
- Pairs to only one Rinnai Tankless Water Heater.
- Compatible with the following Wireless Demand Recirculation Accessories: Push Button, Motion Sensor and Temperature Sensor.

Dimensions (w, h, d):

- Module: 3.69" x 3.69" x 1.18" (94 mm x 94 mm x 29.97 mm)
- Shipping Carton: 6.125" x 2.88" x 6" (155.6 mm x 73 mm x 152.4 mm)

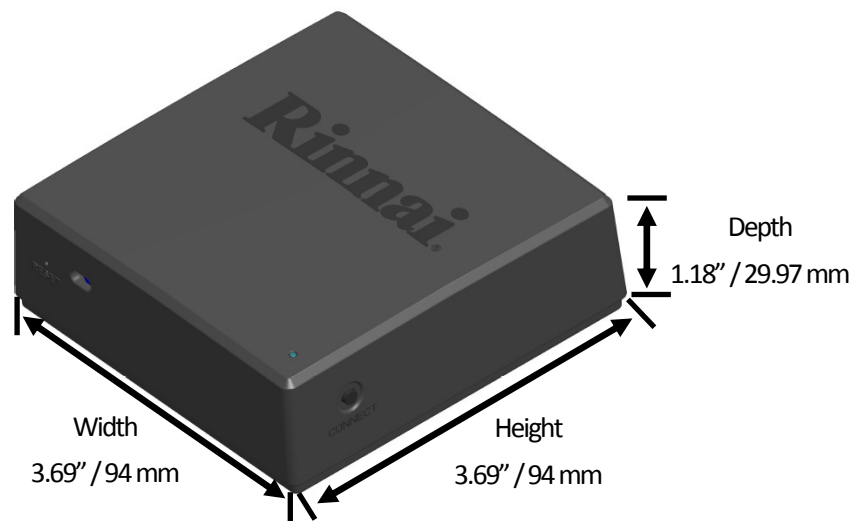

Weight:

Module: 4.8 oz (0.14 kg) Shipping Carton: 6 oz (0.17 kg)

Supported Devices:

- Apple® devices (iPhone, iPad, etc.) running operating system 8.0 or higher
- Android® devices (phones, tablets, etc.) running operating system 4.4 or higher
- BlackBerry® devices are NOT supported

Compatibility:

- 802.11N Wi-Fi Network up to 2.4 GHz
- NOT COMPATIBLE with the MC-195T-US or MC-100V controllers

Unpack System Contents

Carefully unpack your system contents. If any part of the system appears damaged, do not attempt to use it. Contact Rinnai Customer Care (1-800-621-9419) or your authorized Rinnai Service Provider.

WARNING: To avoid danger of suffocation, keep plastic bags out of the reach of children.

Check to be sure your system includes the following parts:

- Rinnai Control-R™ Module (including 5 feet/1.5 meters of wire for water heater connection)
- Wall mounting hardware (2 anchors/2 screws)
- Rinnai Control-R™ Wi-Fi Module Installation Manual (this document)

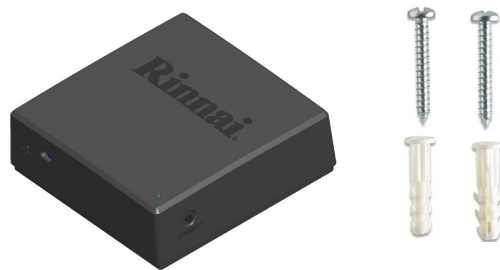

Required Devices, Tools and Information (Customer-Supplied)*

- Mobile device connected to home/business network
- Router with Wi-Fi
- Wireless network name and Wi-Fi password
- 2.4GHZ Wi-Fi network with WPA 2 security protocols
- Water Heater Serial Number or QR Code (located on water heater left side panel on cardboard packaging)
- Tools (Below are example images of required tools and are used for illustrative purposes only. Your tools may differ from the images shown below.)

* **Note:** The above items, with the exception of the tools, are not required if operating only the Wireless Demand Recirculation accessories (Push Button, Motion Sensor and Temperature Sensor).



Phillips Screwdriver



Flat Blade Screwdriver



Wire Stripper/Crimping Tool



Drill and Bit Set

Note: Wire Stripper/Crimping Tool required only if extending the length of the wires that connect the module to the water heater.

Select Module Location

Use the following guidelines to select a location for the module.

- Choose a central location inside the home or business where the Wi-Fi signal is strong.
Note: If the water heater is located where the Wi-Fi signal is weak (such as basements or a mechanical room), the module is designed so that wiring can run up to 300 feet (91 meters) away from the tankless water heater to ensure a strong Wi-Fi signal (18-22 gauge wire is required).
- Ensure that adequate space surrounds the module for service and support needs.
- For outdoor water heaters, the module must be installed indoors.
- The module is magnetic and can be placed on the side of the Rinnai tankless water heater (indoor models only) or mounted to a wall. See the next section for installation instructions.

Install Module

Two options are available for installing the module:

Option 1: Magnetic Mount

The module contains a strong magnetic backing and can easily be placed on the side of the water heater (*indoor models only*).

Option 2: Wall Mount

The module can be mounted to a wall with the supplied mounting hardware. Refer to the next section for steps on mounting the module to a wall.

Mount the Module to a Wall

You Will Need:

- Two (2) anchors and two (2) screws (supplied with system)
- Tools shown in the **Unpack System Contents** section

Instructions:

1. The module's back panel contains two keyhole slots that support the module. Mark the location of each slot on the wall with a pencil. The distance between the two slots is 1.9" (48 mm).

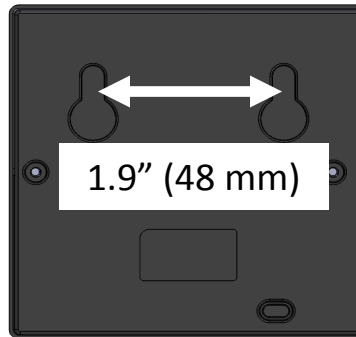

2. Use a level to ensure the slots are even. Use a power drill to drill pilot holes for the module screws and anchors.
3. Insert the supplied two wall anchors into each hole until they sit flush against the wall.

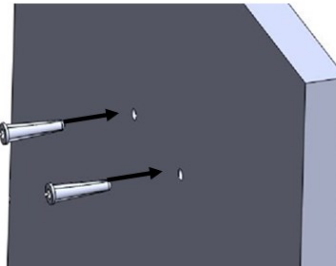

4. Insert the supplied screws into the anchors and fasten to the wall leaving 1/4" exposed.

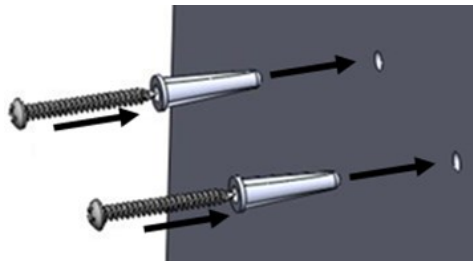

5. Mount the module by placing the keyhole slots (on back of module) onto the screws.

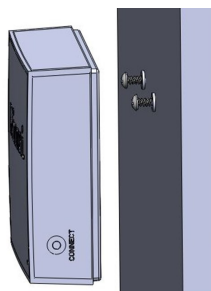

Connect Module to Water Heater



WARNING

To protect yourself from harm, follow the steps below before wiring the module:

- Turn off the electrical power supply by unplugging the power cord or by turning off the electricity at the circuit breaker. The temperature controller does not control the electrical power.
- Turn off the gas at the manual gas valve, usually located immediately below the water heater.
- Turn off the incoming water supply. This can be done at the isolation valve immediately below the water heater or by turning off the water supply to the building.

1. Unplug the water heater.

Note: Pressing the ON/OFF button on the controller does not completely power off the water heater.

2. Remove the four (4) screws located on the water heater cover.
3. Two (2) wires are attached to the bottom of the module. Place these wires through the bottom opening of the water heater.
4. Attach each module wire to the remote control connection terminals by following the steps below.

- a. Partially unscrew each of the two screws.
- b. Insert the spade terminal (connected to the end of each wire) between the screw and the contact.
- c. Tighten the screws.



spade terminal

5. Replace and tighten the four (4) screws on the water heater cover.

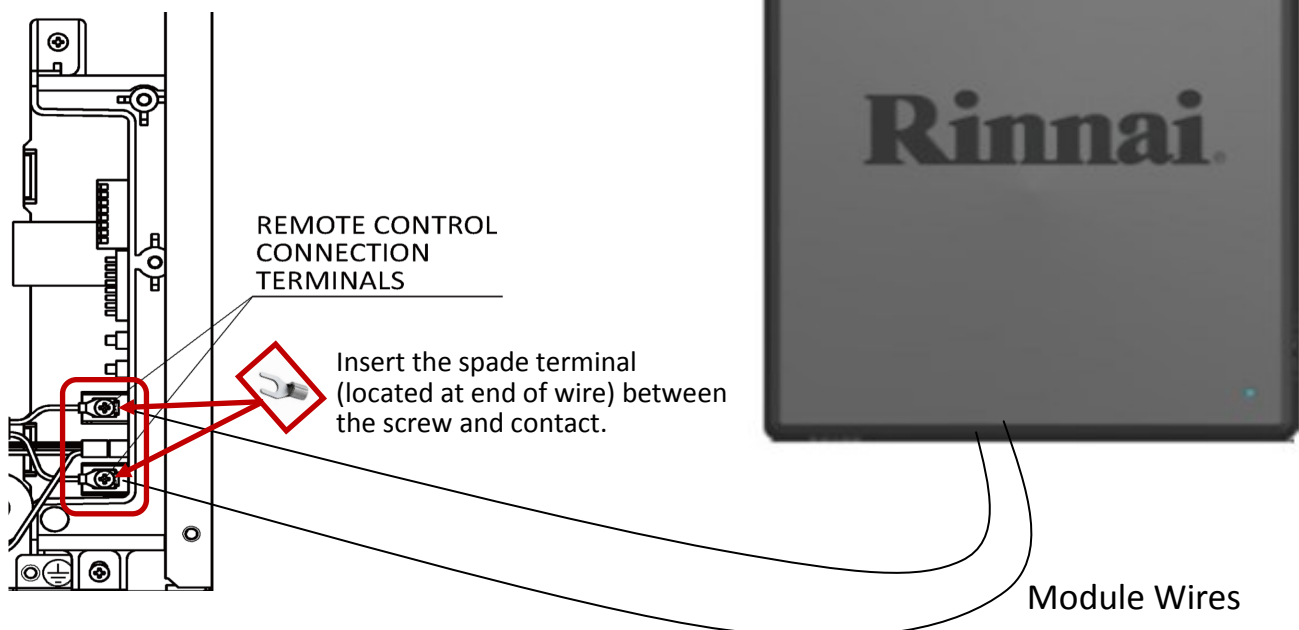

Connect to a Wi-Fi Network

This Section Must be Performed by the Water Heater Owner (Homeowner/Business Owner)

1. Power on the water heater. The LED light on the module will blink yellow until boot-up is complete and will then turn solid red.

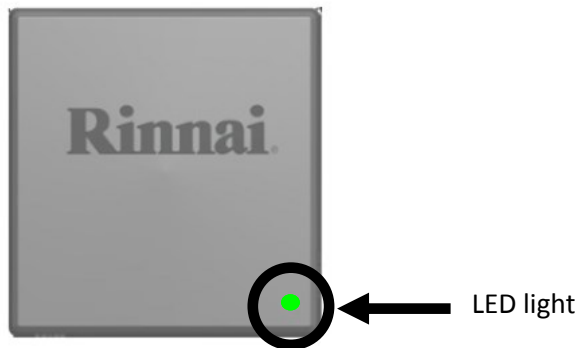

2. Download the Rinnai app from the Apple® Store or Google® Play Store.



Rinnai Heater
Rinnai America Corporation

3. Connect the module to your Wi-Fi network. When setup is complete, the owner will have access to remotely monitor and control their Rinnai tankless water heater using their smart device.
 - For Apple® devices, see the next section entitled **Connect to Wi-Fi on Apple® Devices**
 - For Android® devices, see the section entitled **Connect to Wi-Fi on Android® Devices**

Connect to Wi-Fi on Apple® Devices

1. Open the Rinnai app. If you are the owner of the module, tap **Consumer Sign up**. If you are a dealer, tap **Dealer Sign up**.

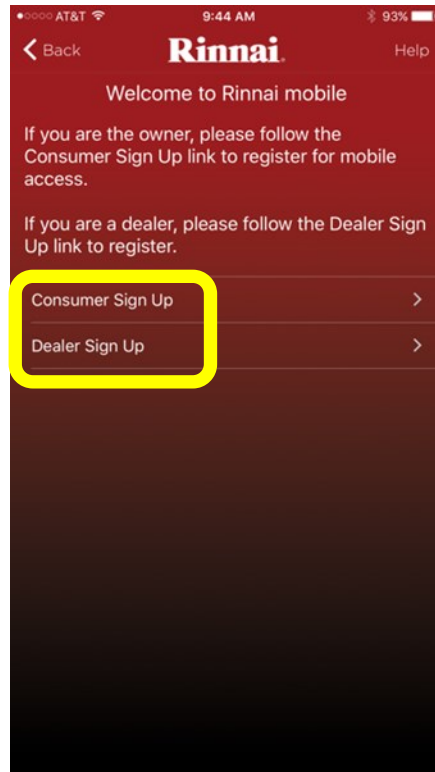

2. Enter your registration information into each field. All fields are required. An onscreen keyboard appears when you select inside a text field. When complete, tap **Sign up** (or press **Done** on the onscreen keyboard).

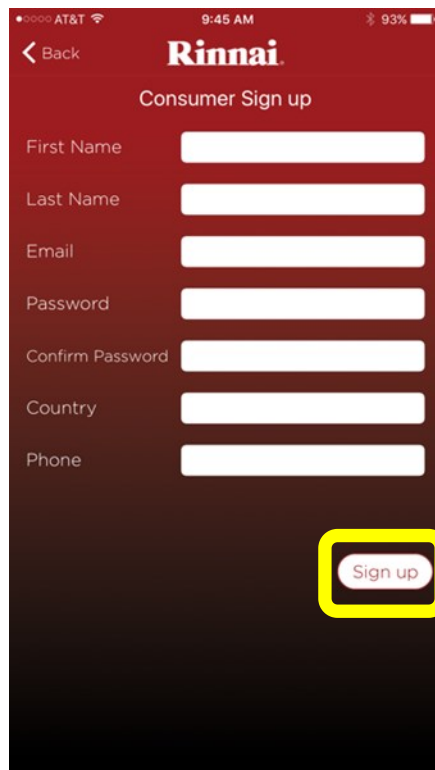

3. A confirmation email will be sent with a link embedded in the message to allow you to complete registration. When the account has been confirmed through the emailed link, return to the Rinnai app and log in with the registered email and password. Next, tap **Sign In**.

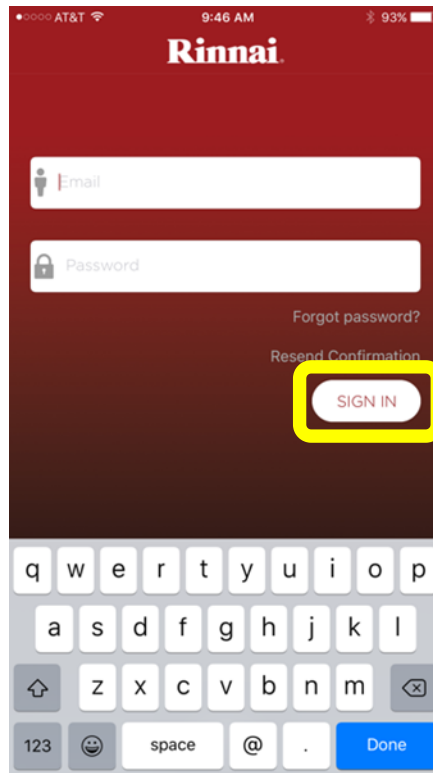

4. Tap **Let's Get Started**.

Note: If you have already registered a module to the Rinnai app, press the + symbol in the top, right corner to add another module to the Rinnai app.

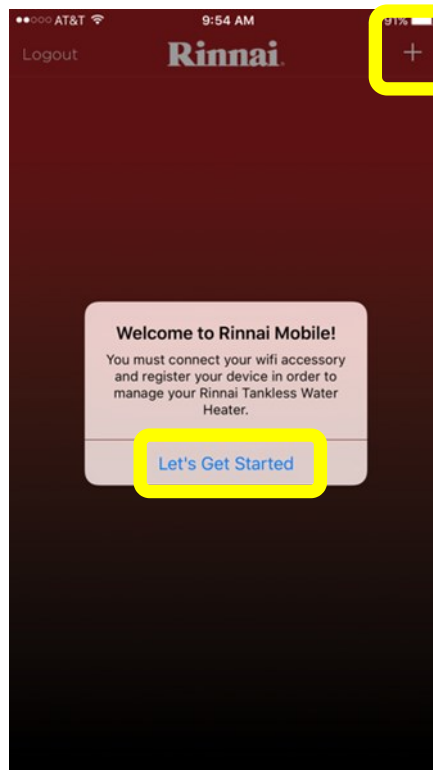

5. Verify that the module is displaying a solid red light and then tap **Scan for Devices**.

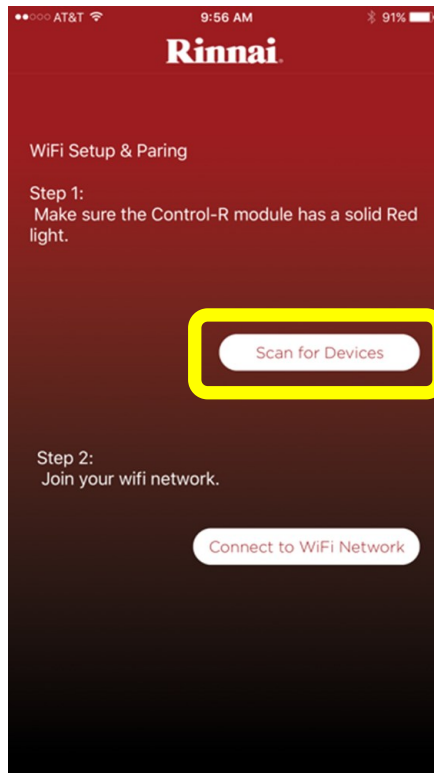

6. Select the **Media Access Control (MAC) address**, which can be found on the back side of the module (make sure your Wi-Fi router is on and that you are near the module).

Next, tap **Back to Rinnai**.

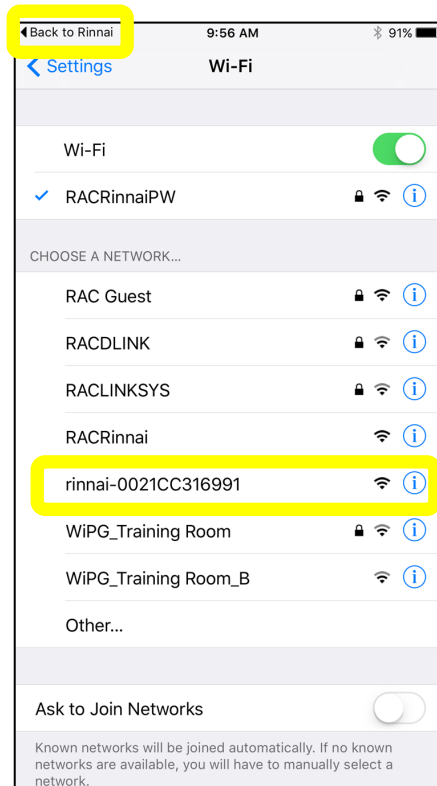

7. Tap **Connect to Wi-Fi Network**.

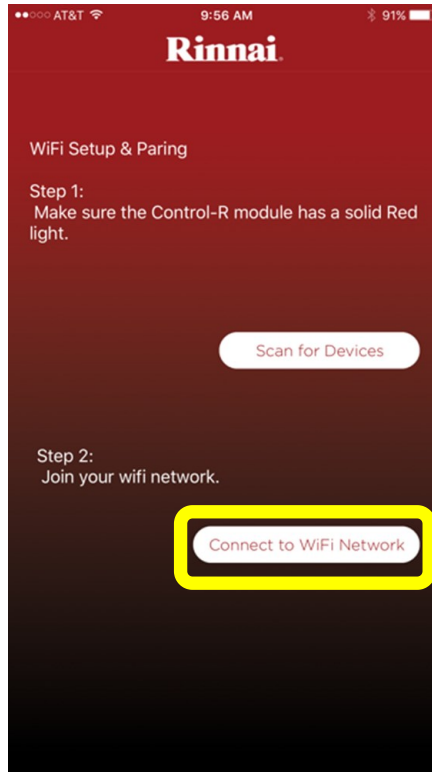

8. The app will scan for local Wi-Fi networks. Tap your network name and enter the password. An onscreen keyboard appears when you select inside a text field.

Next, tap **Connect**. The LED light on the module will blink blue when the module is connected to the network.

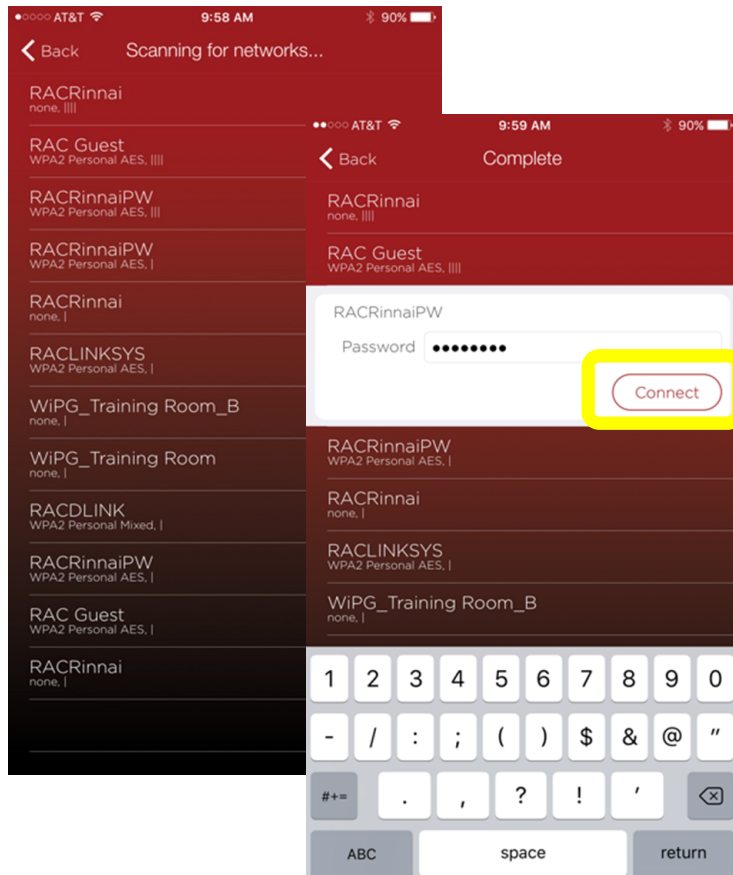

9. Press the **Connect** button on the module. Next, tap **Register** in the Rinnai app.

The registration process must be completed within 2 minutes from the time the Connect button is pressed.

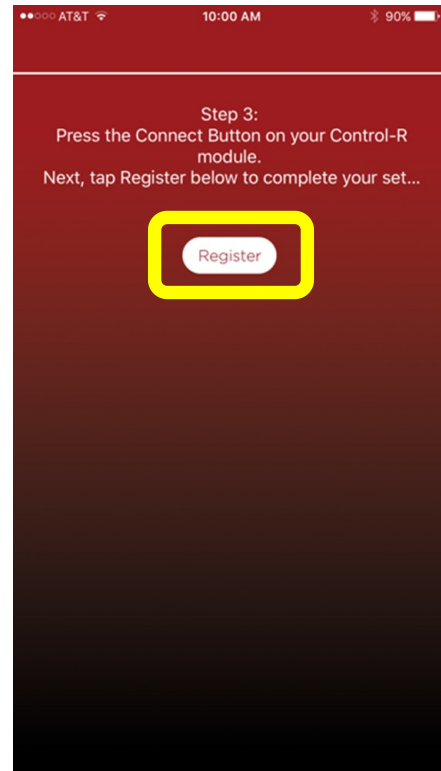
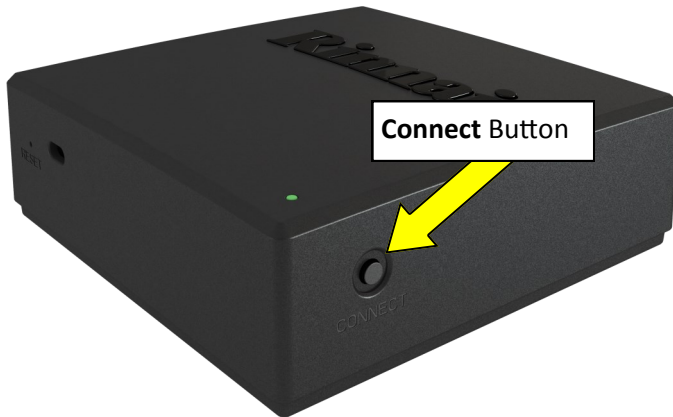

10. Enter the water heater serial number. The serial number can be scanned into the app if the water heater has a QR code located next to the serial number. The serial number is located on the left side panel of the water heater and on the cardboard packaging (example: AB.CD-123456).

Next, tap any area within the Model # and Serial # area (highlighted in the box shown below).

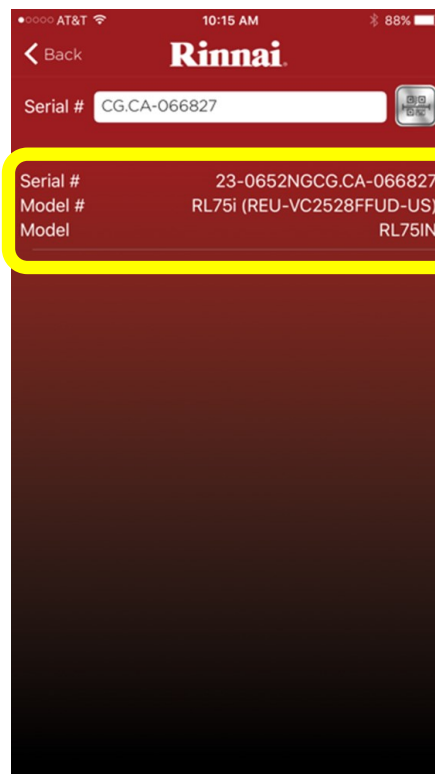
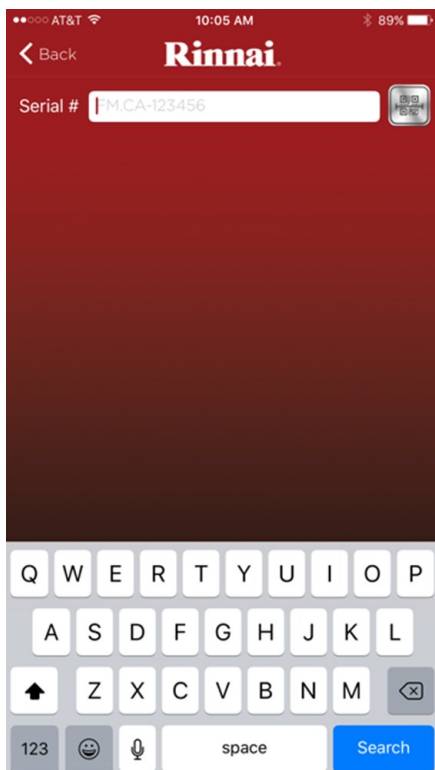

Tap any area located within this box.

11. Tap **Select Application Type** and select the type of application.

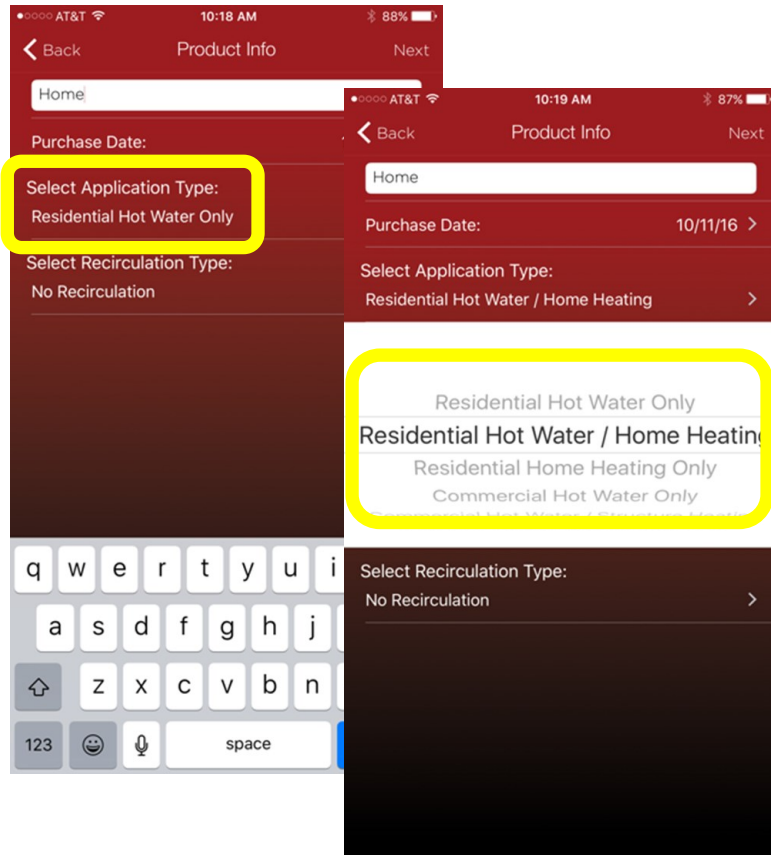

12. Tap **Select Recirculation Type** and select the type of recirculation system. Then, tap **Next**.

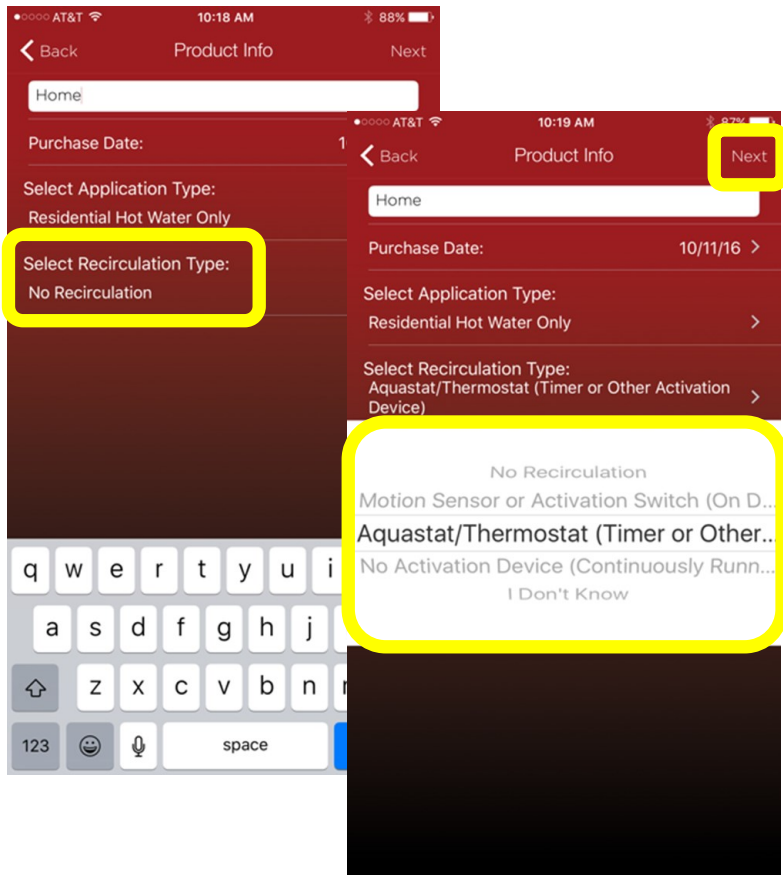

13. The fields shown below should autofill from the Rinnai app user registration fields. Enter any missing information and then press **Next**. All fields are required.

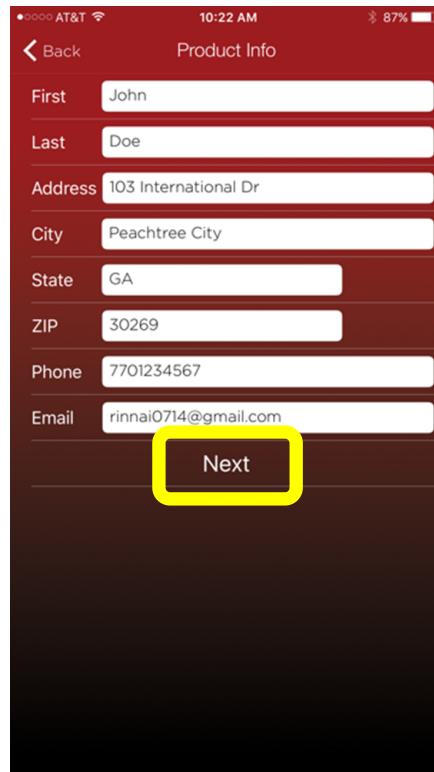

14. The Rinnai app allows you to select a Rinnai dealer to monitor your water heater for maintenance and status. To assign a dealer to your water heater, enter the dealer's email address and tap **Assign Dealer Monitoring**. The email address can be obtained by contacting your preferred dealer.
- To complete this step at a later date, tap **No Thanks, Maybe Later**.
 - If you do not want a Rinnai dealer to monitor your water heater, tap **Stop Dealer Monitoring**.

When complete, tap **Next**.

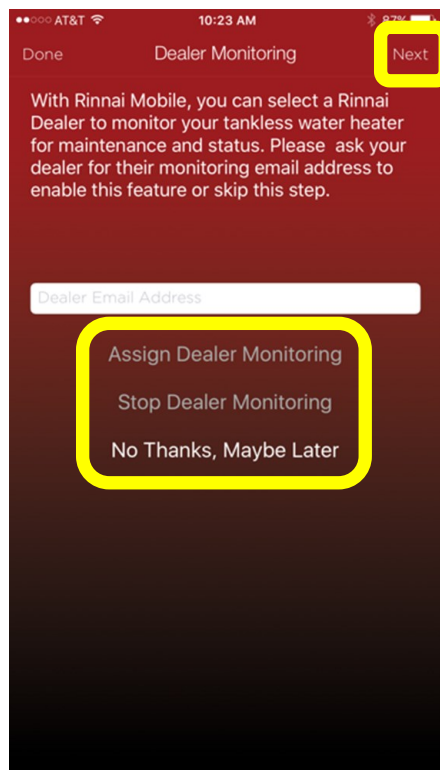

15. Registration is complete.

- To register another unit, tap **Register Another Unit**.
- If you are done, tap **Home**. The app controller screen appears.

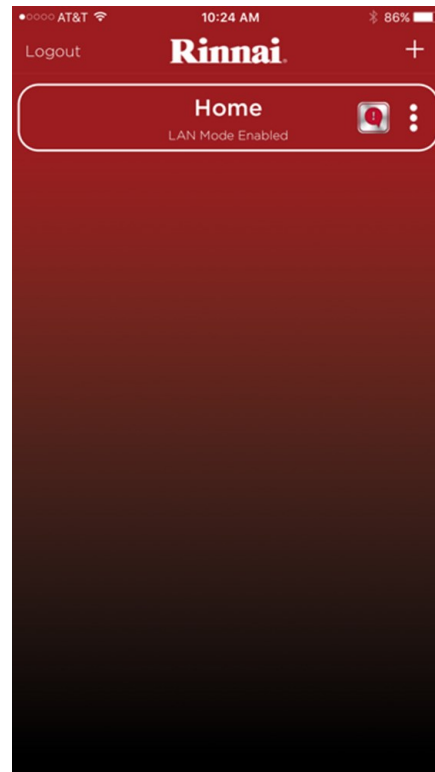
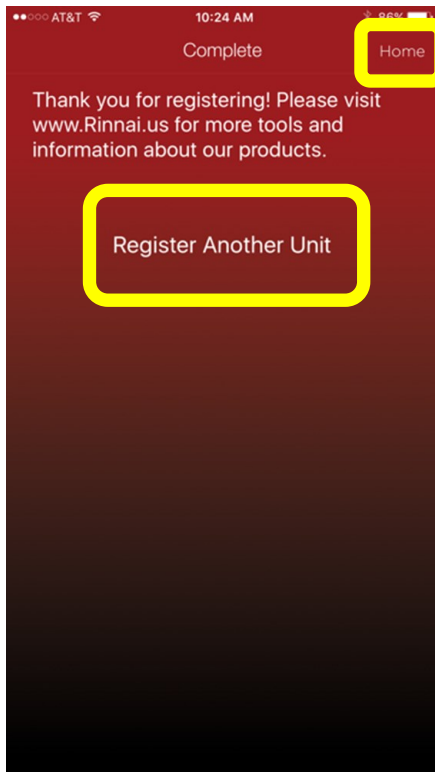

Next Steps:

This concludes the **Connect to Wi-Fi on Apple® Devices** section.

The module can be paired with the following Wireless Demand Recirculation Accessories: Push Button, Motion Sensor and Temperature Sensor. If your system has recirculation capability, refer to the instructions included in the recirculation accessory package. The accessory installation instructions can also be viewed online at www.rinnai.us/wifi.

Connect to Wi-Fi on Android® Devices

1. Open the Rinnai app and tap **Sign Up**.

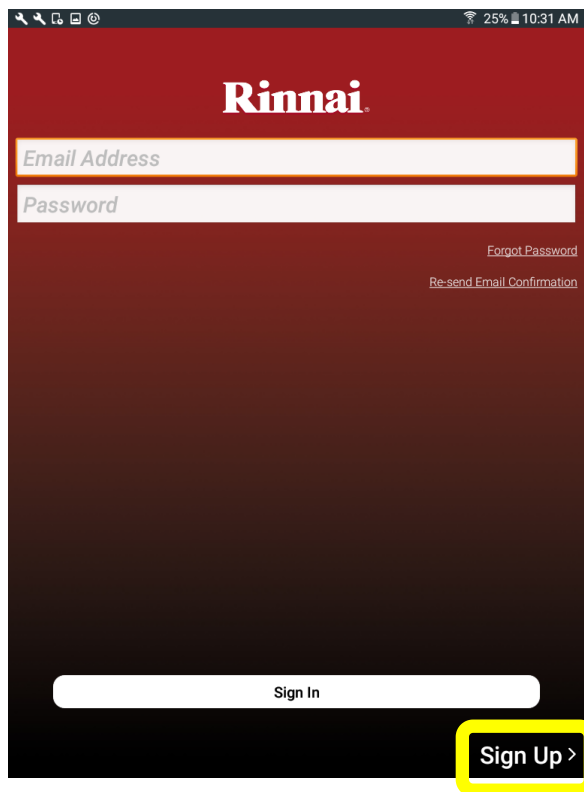

2. If you are the owner of the module, tap **Consumer Sign up**.
If you are a dealer, tap **Dealer Sign up**.

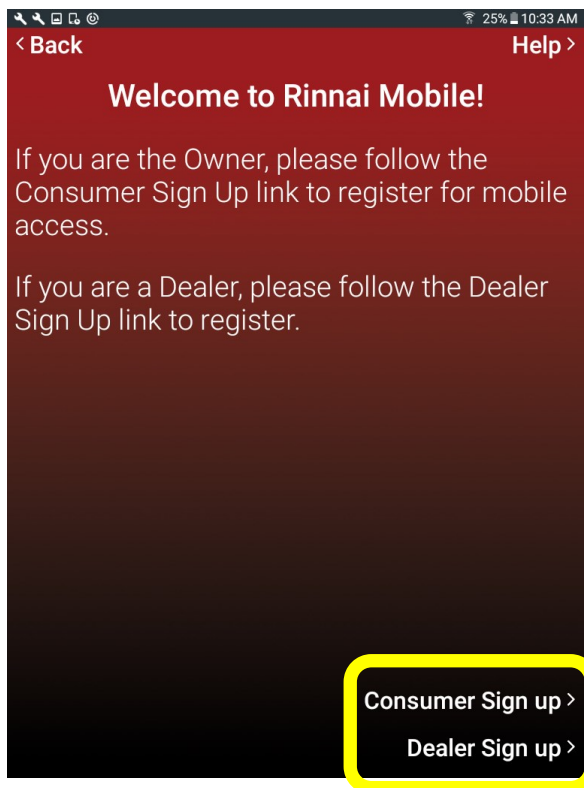

3. Enter your registration information into each field. All fields are required. An onscreen keyboard appears when you select inside a text field. When complete, tap **Signup** (or press **Done** on the onscreen keyboard).

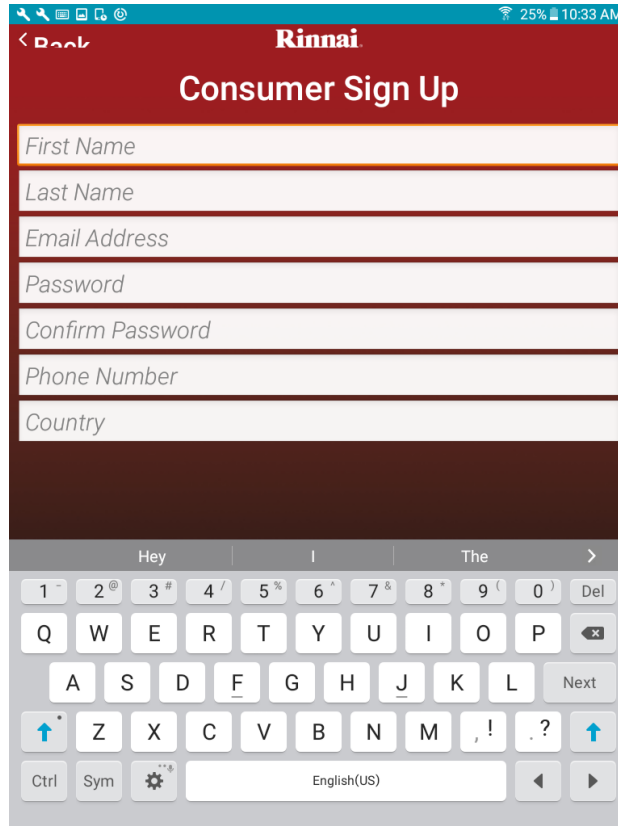

4. A confirmation email will be sent with a link embedded in the message to allow you to complete registration. When the account has been confirmed through the emailed link, return to the Rinnai app and log in with the registered email and password. Next, tap **Sign In**.

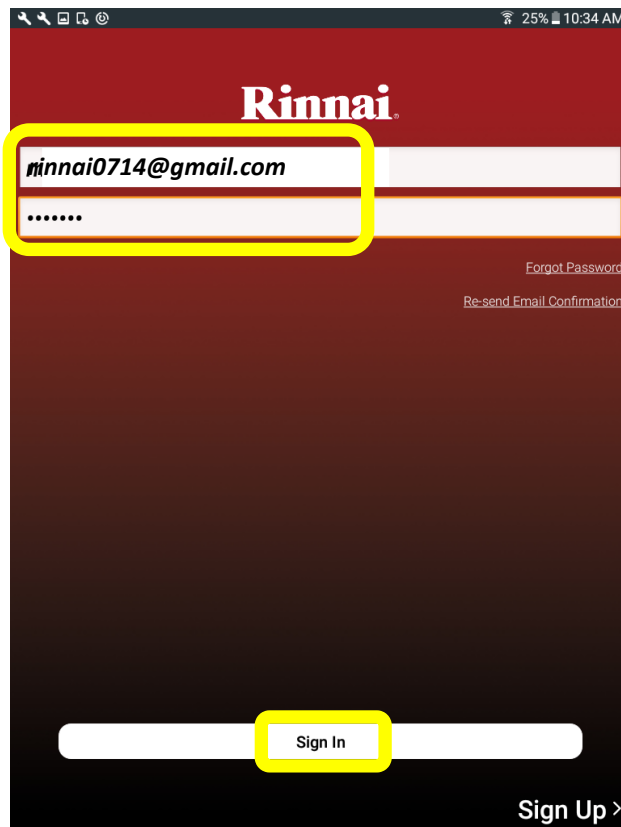

5. Tap **Let's Get Started**.

Note: If you have already registered a module to the Rinnai app, press the + symbol in the bottom, right corner to add another module to the Rinnai app.

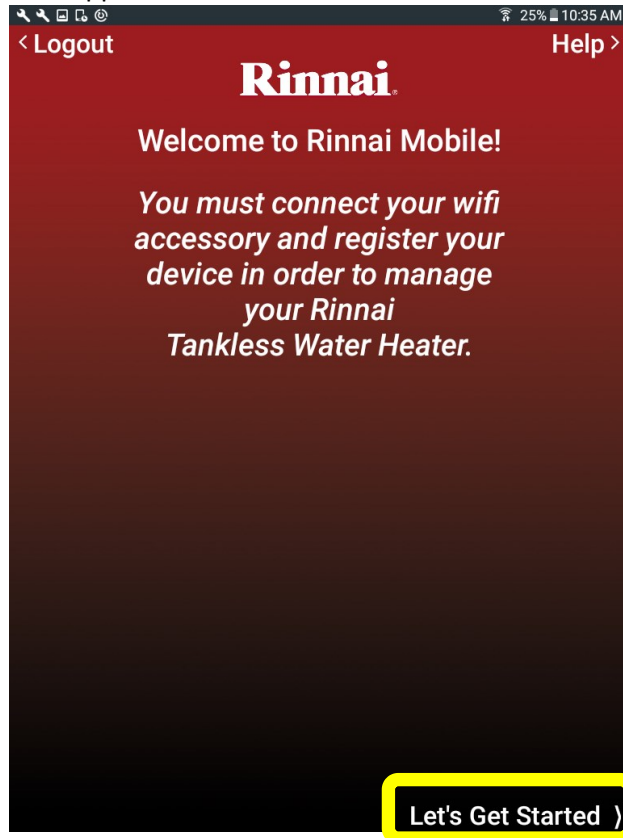

6. Select the **Media Access Control (MAC) address**, which can be found on the back side of the module (make sure your Wi-Fi router is on and that you are near the module).

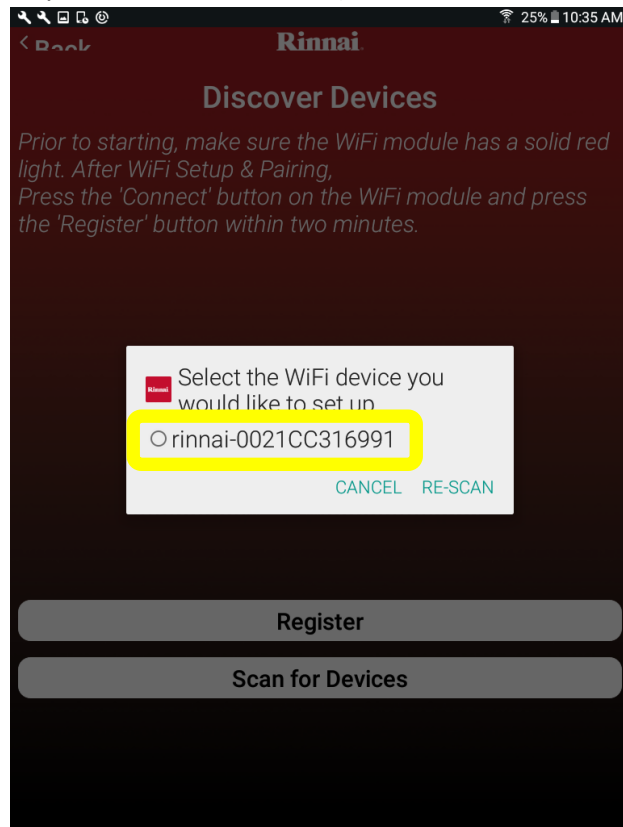

- The app will scan for local Wi-Fi networks. Tap your network name and enter the password. An onscreen keyboard appears when you select inside a text field.

Next, tap **Connect Device**. The LED light on the module will blink blue when the module is connected to the network.

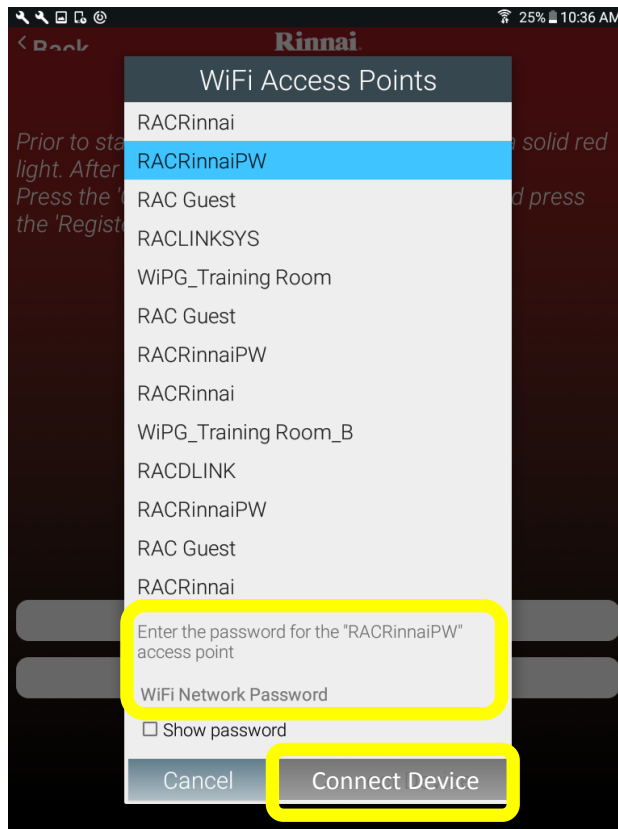

- Press the **Connect** button on the module. Next, tap **Register** in the Rinnai app.

The registration process must be completed within 2 minutes from the time the Connect button is pressed.

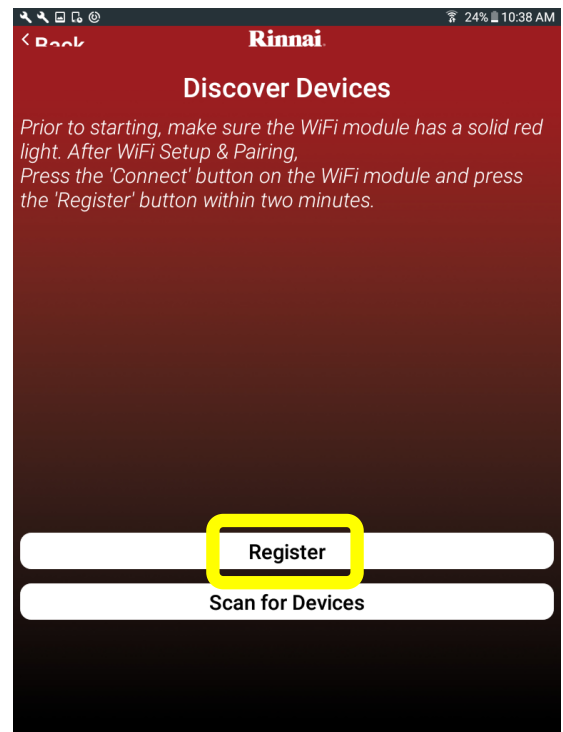

9. Enter the water heater serial number. The serial number can be scanned into the app if the water heater has a QR code located next to the serial number. The serial number is located on the side panel of the water heater and on the cardboard packaging (example: AB.CD-123456).

Next, tap on the serial number.

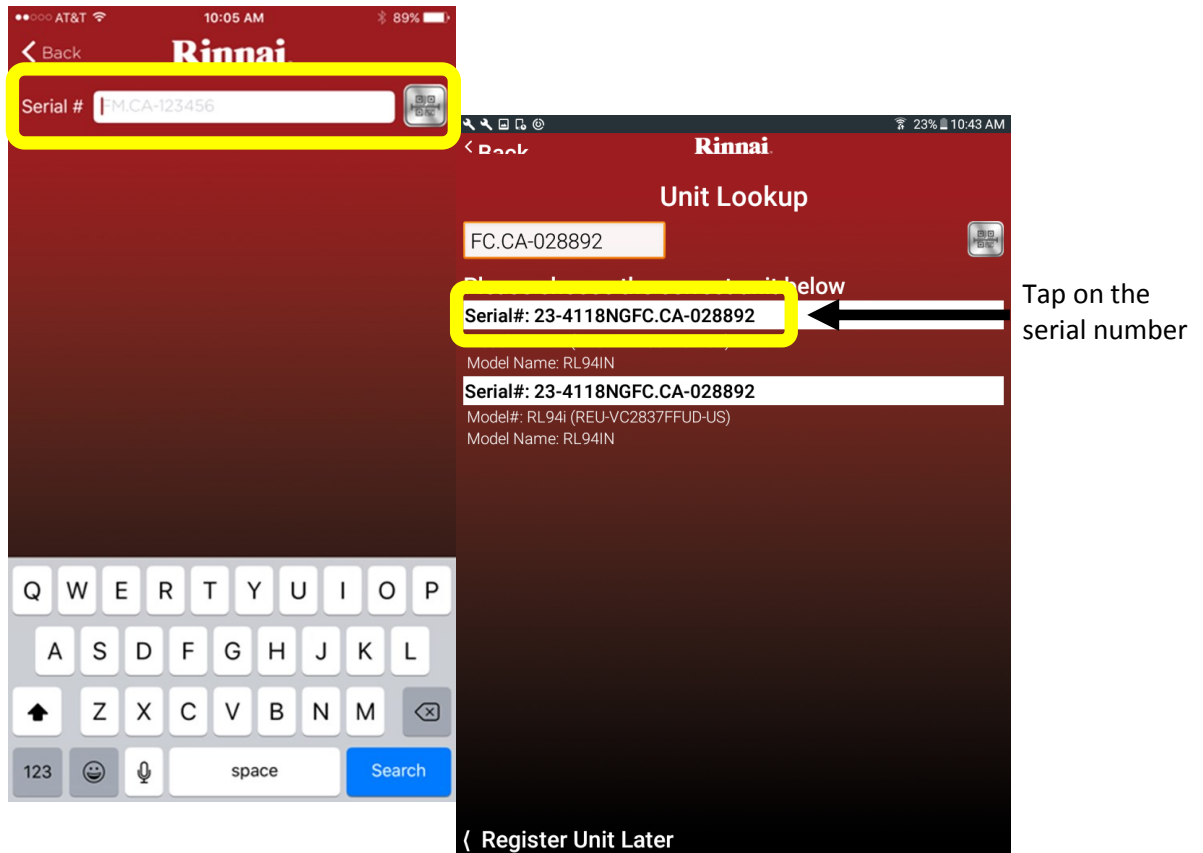

10. Tap **Application Type** and select the type of application.

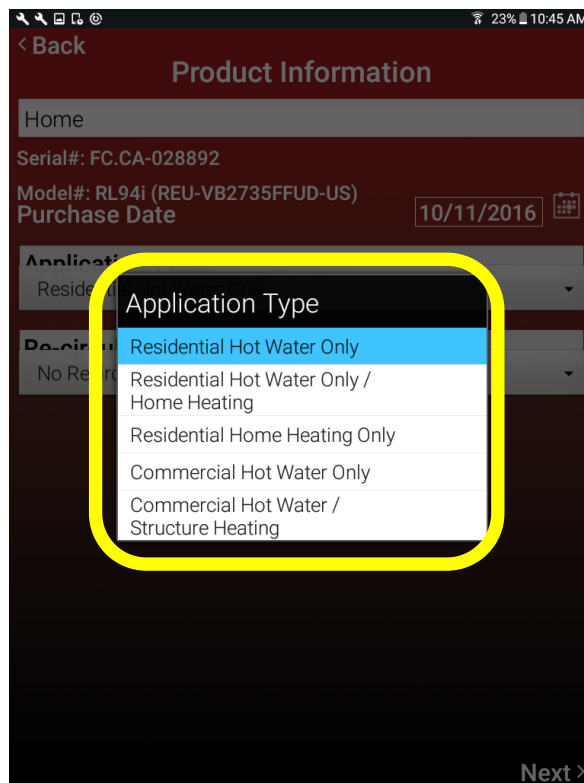

11. Tap **Re-circulation Type** and select the type of recirculation system. Then, tap **Next**.

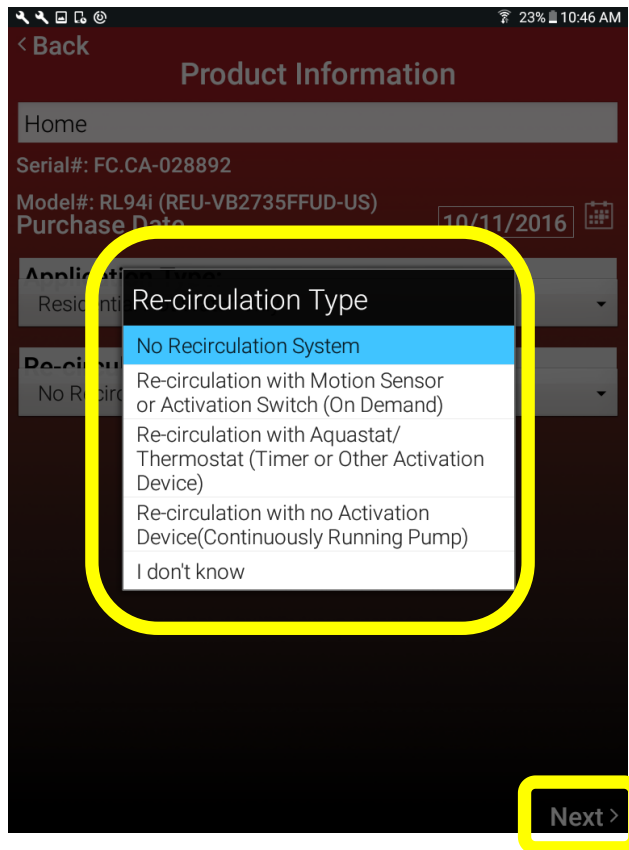

12. Enter the owner information and tap **Next**. Each field is required.

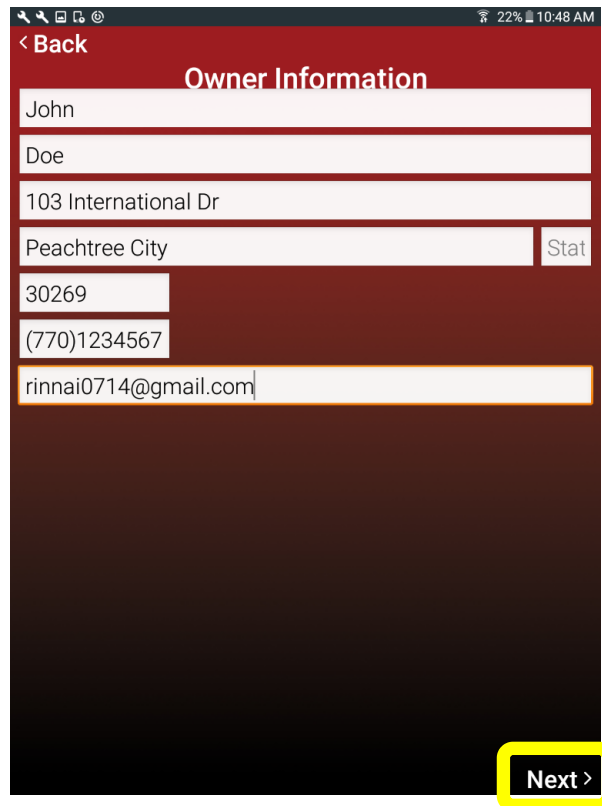

13. The Rinnai app allows you to select a Rinnai dealer to monitor your tankless water heater for maintenance and status. To assign a dealer to your water heater, enter the dealer's email address and tap **Assign Dealer Monitoring**. The email address can be obtained by contacting your preferred dealer.

- To complete this step at a later date, tap **No Thanks, Maybe Later**.
- If you do not want a Rinnai dealer to monitor your tankless water heater, tap **Stop Dealer Monitoring**.

When complete, tap **Next**.

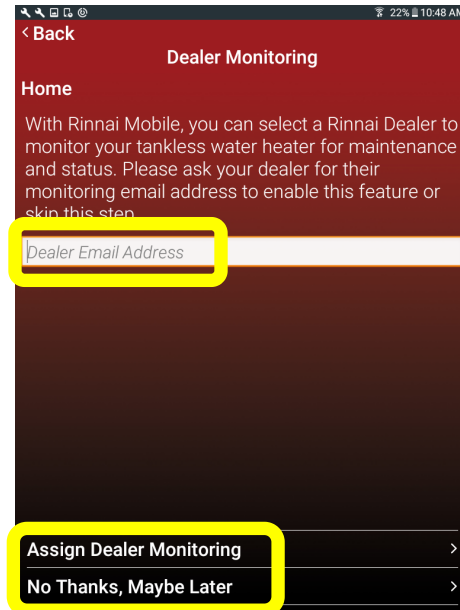

14. Registration is complete.

- To register another unit, tap **Register Another Unit**.
- If you are done, tap **I'm Done**. The app controller screen appears.

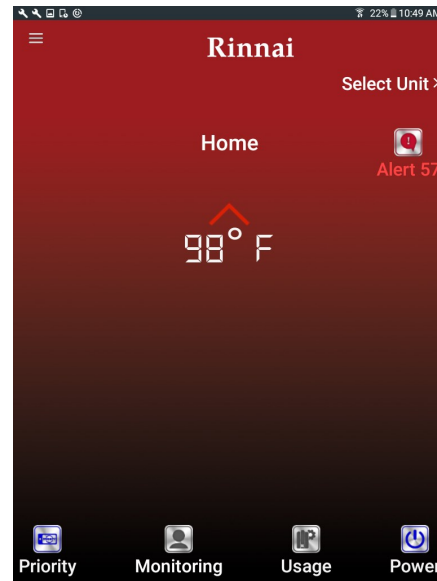
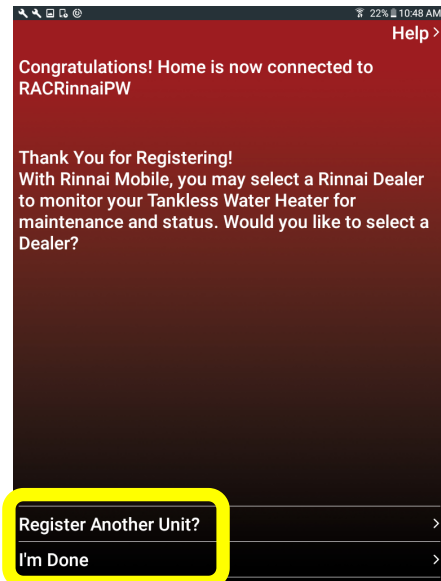

Next Steps:

This concludes the **Connect to Wi-Fi on Android® Devices** section.

The module can be paired with the following Wireless Demand Recirculation Accessories: Push Button, Motion Sensor and Temperature Sensor. If your system has recirculation capability, refer to the instructions included in the recirculation accessory package. The accessory installation instructions can also be viewed online at www.rinnai.us/wifi.

LED Color Codes

Color	Blink Frequency	State / Condition	Duration
YELLOW	Solid	Start of Boot-up Sequence	Until next state change
RED	Solid	Error Condition / Not Provisioned	Until next state change
RED	0.5 Hz On 1 second, Off 1 second	Wi-Fi Provisioned, but No IP Address Yet	Until IP address obtained
GREEN	Solid	ZigBee* Pairing Mode Active	Until next state change: Timeout or successful ZigBee join
GREEN	0.5 Hz On 0.25 seconds, Off 0.25 seconds	ZigBee* Join Success	2 seconds
BLUE	2 Hz On 0.25 seconds, Off 0.25 seconds	Wi-Fi Network Successfully Joined	Until next state change: Cloud service connection
BLUE	0.5 Hz On 1 second, Off 1 second	Attempting Gateway Registration with Cloud Service	Until next state change: Successful registration with Cloud Service
BLUE	SOLID	Ready to Use / Normal Operation	Until next state change
PURPLE	0.5 Hz On 1 second, Off 1 second	Lost Connection to Wi-Fi Network	Until connection is re-established
PURPLE	SOLID	Lost Connection to Internet	Until connection is re-established
WHITE	.5 Hz On 1 second, Off 1 second	Factory Reset Mode Possible	Until button is released

* ZigBee is a wireless technology that is used for remote control and sensor applications. Zigbee is used for device-to-device communication, such as Rinnai's recirculation accessories and Control-R™ Wi-Fi Module.

Troubleshooting

Symptom	Solution
LED on module does not turn on.	<ul style="list-style-type: none">• Ensure the module is properly connected to the Terminals for Control on the PC Board.• Ensure power is supplied to the water heater.
Rinnai App cannot detect Local Area Network (LAN) Wi-Fi signal.	<ul style="list-style-type: none">• Ensure the Local Area Network (LAN) Wi-Fi meets the requirements of the module.• Ensure Wi-Fi router is powered and properly functioning.• Ensure Local Area Network (LAN) Wi-Fi is functioning.• Ensure module is installed in a location with strong signal strength.
Local Area Network (LAN) Wi-Fi signal is detected but the Rinnai App cannot connect.	<ul style="list-style-type: none">• Ensure correct Local Area Network (LAN) Wi-Fi password has been entered (if required).• Press Cancel in the Rinnai App and repeat the setup process starting from pairing the module with the Rinnai App.
Module is paired and connected (LED is blinking blue) to Local Area Network (LAN) Wi-Fi but registration is interrupted.	Return to the Add Device screen. Press the Connect button on the module and then press the Register button in the Rinnai App.

- For further information concerning the Wi-Fi router, please contact the router manufacturer.
- For further information regarding internet service, please contact the Internet Service Provider (ISP).
- For all other questions, contact Rinnai Customer Care at 1-800-621-9419.

Pairing Instructions

The module can be paired with the following Wireless Demand Recirculation Accessories: Push Button, Motion Sensor and Temperature Sensor.



Push Button

Part Number
RWMPB01



Motion Sensor

Part Number
RWMMS01



Temperature Sensor

Part Number
RWMTS01

For complete instructions on installing and pairing the Wireless Demand Recirculation Accessories to the module, refer to the instructions included in the accessory package.

The accessory installation instructions can be viewed online at www.rinnai.us/wifi.

Notes

A tradition of **TRUE RELIABILITY.**

For nearly 100 years, we at Rinnai have been fiercely committed to delivering nothing less than a superior experience at every touch point.

Beyond manufacturing the highest quality products, our people stand behind all that we make—before, during and long after installation. From the 24/7/365 technical support for professionals, to our national network of independent installers, to on-staff engineers who can assist with choosing the right products and sizes—we're inspiring confidence right along with the comfort our solutions provide.



Rinnai[®]

Learn more about Rinnai high-performance Tankless Water Heaters,
Hybrid Water Heating Systems, Boilers, Vent-Free Fan Convectors
and EnergySaver[®] Direct Vent Wall Furnaces at:

rinnai.us

Rinnai America Corporation • 103 International Drive, Peachtree City, GA 30269
1-800-621-9419 • rinnai.us

©2015 Rinnai America Corporation. Rinnai America Corporation continually updates materials, and as such, content is subject to change without notice. Local, state provincial, federal and national fuel gas codes must be adhered to prior to and upon installation.

10000400
10/2016