



Lithium-ion 2-IN-1 Cordless Trimmer/Edger

Model No. TRJ600C

Form No. SJ-TRJ600C-880E

A Division of Snow Joe, LLC

OPERATOR'S MANUAL

IMPORTANT!

Safety Instructions

All Operators Must Read These Instructions Before Use

General Power Tool Safety Warnings

WARNING

Read all safety warnings and all instructions Failure to follow all warnings and instructions may result in electric shock, fire or serious injury.

Save all warnings and instructions for future reference

Work Area

- Keep work areas clean and well lit. Cluttered and dark areas invite accidents.
- Do not operate power tools in explosive atmospheres, such as in the presence of flammable liquids, gases, or dust. Power tools create sparks which may ignite the dust or fumes.
- Keep children and bystanders away while operating a power tool. Distractions can cause you to lose control.

Personal safety

- **Stay alert, watch what you are doing and use common sense when operating a power tool.** Do not use a power tool while you are tired or under the influence of drugs, alcohol, or medication. A moment of inattention while operating power tools may result in serious personal injury.
- **Use safety equipment.** Always wear eye protection. Safety equipment such as a dust mask, non-skid safety shoes, hard hat, or hearing protection used for appropriate conditions will reduce personal injuries.
- **Avoid accidental starting.** Ensure the switch is in the off-position before plugging in. Carrying power tools with your finger on the switch or plugging in power tools that have the switch on invites accidents.
- **Remove any adjusting key or wrench before turning the tool ON.** A wrench or a key that is left attached to a rotating part of the power tool may result in personal injury.
- **Ensure you always have proper footing and balance.** This will provide better control of the power tool in unexpected situations.

- **Do not overreach.** Keep proper footing and balance at all times. This enables better control of the power tool in unexpected situations.
- **Dress properly.** Do not wear loose clothing or jewellery. Keep your hair, clothing and gloves away from moving parts. Loose clothes, jewellery or long hair can be caught in moving parts.
- **If devices are provided for the connection of dust extraction and collection facilities ensure that these are connected and properly used.** Use of these devices can reduce dust-related hazards.

Power Tool Use and Care

- **Do not use the power tool for applications that are beyond its capacity.** Use the correct power tool for your application. The correct power tool will do the job better and safer at the rate for which it was designed.
- **Do not use the power tool if the switch does not turn it ON and OFF.** Any power tool that cannot be controlled with the switch is dangerous and must be repaired.
- **Disconnect the battery from the power source before making any adjustments, changing accessories, or storing power tools.** Such preventive safety measures reduce the risk of starting the power tool accidentally.
- **Store the tool out of the reach of children.** Do not allow people unfamiliar with the power tool or these instructions to operate the power tool. Power tools are dangerous in the hands of untrained users.
- **Always maintain the power tool.** Check for misalignment or binding of moving parts, breakage of parts, or other conditions that would affect its operation. If damaged, have the power tool repaired before use. Many accidents are caused by poorly maintained power tools.
- **Keep cutting tools sharp and clean.** Properly maintained cutting attachments with sharp cutting edges are less likely to bind and are easier to control.
- **Only use the tool, accessories, and attachments as described in these instructions.** Using the tool for operations it is not intended for could cause damage to the tool and hazardous situations. Always consider the working conditions and the work to be performed.

Service

- Have the power tool serviced by a qualified repair personnel using only manufacturer's recommended replacement parts. This will ensure that the safety of the power tool is maintained.

Additional safety rules for line trimmers

- Always wear adequate protective clothing when operating the tool to avoid injuries to face, eyes, hands, feet, head or hearing. Use safety glasses or a face shield, high boots or sturdy shoes, long trousers, work gloves, a hard hat and hearing protection.
- When starting up and when the tool is in operation, keep the cutting section away from all parts of the body, especially the hands and feet.
- Do not start the tool when it is upside down or when it is not in the operating position.
- Switch the motor off and remove battery when the tool is not being used, left unattended, being cleaned, being moved from one place to another or when the spool is being changed or the length of line manually adjusted.
- Do not operate the tool near people, especially children or pets. Turn it off if they get too close. Maintain a safe distance of at least 5m from other people when using the tool.
- Keep a balanced and stable stance while using the tool.
- Ensure that the area being cut is free from strings, stones and debris.
- Do not cut against hard objects. This could cause injury to the operator and damage to the tool.
- Never use the tool without the guard. Never use the tool if the guard is damaged.

WARNING

The guard is vital for your and other people's safety and for the tool's operating efficiency.

- Do not try to stop the cutting device (nylon line) with your hands. Always let it come to a stop by itself.
Warning. After switching off the tool, the cutting device continues to rotate for a few more seconds.
- Only use the original type of nylon line. Under no circumstances use metal line instead of nylon.
- Do not use the tool to cut grass which is not on the ground. For example, do not cut grass which is on walls or rocks.
- Do not switch on the tool in enclosed or poorly ventilated spaces or in the presence of inflammable and/or explosive substances such as liquids, gasses and powders.
- Only cut during broad daylight or with adequate artificial light.
- Check that all grass cuttings and dirt have been removed from the ventilation vents.
- Do not cross roads or gravel paths with the tool still running.
- When the tool is not in use, store it in a dry place and out of reach of children.

- After use, disconnect the tool from the power supply and check for damage. If you have the slightest doubts, contact an authorized service center.
- Only use the tool according to the instructions given in this manual.
- Check regularly that the screws are tight.
- Do not try to repair the tool or access internal parts. Contact authorized service centers only.
- Do not get distracted and always concentrate on what you are doing. Use common sense. Never operate the tool when you are tired, sick or under the influence of alcohol or other drugs.







Unpacking

Due to modern mass production techniques, it is unlikely that your power tool is faulty or that a part is missing. If you find anything wrong, do not operate the tool until the parts have been replaced or the fault has been rectified. Failure to do so could result in serious personal injury.

Contents of carton

- Debris shield
- Edging wheel
- 1 x Li-ion battery pack
- Strap
- Battery charger

Explanation of Symbols:

Symbol	Description
	<p>Read instruction manual.</p>
	<p>Wear hearing protection. Wear eye protection. Wear breathing protection.</p>
	<p>Conforms to relevant standards for electromagnetic compatibility.</p>
	<p>Use at a distance of at least 5m from other people.</p>
	<p>Do not use in the rain.</p>
	<p>Thrown objects and rotating line can cause severe injury.</p>
	<p>Sharp blade.</p>

Know Your Cordless Trimmer/Edger

Before using the line trimmer, familiarize yourself with all the operating features and safety requirements.

This line trimmer is to be used for trimming soft, new growth only. Do not use the tool or accessories for applications it is not designed for. Using the tool, or accessories for applications it is not designed for may present a safety risk or damage to the product.

1. Battery
2. Handle
3. Trigger switch
4. Lock-off button
5. Handle adjustment button
6. Secondary handle
7. Telescopic shaft adjustment knob
8. Telescopic shaft
9. Head adjustment button
10. Motor housing
11. Flower guard
12. Helix-line
13. Automatic feed spool
14. Debris shield
15. Line cutting blade
16. Edging wheel
17. Strap
18. Battery charger
19. Handle rotating knob
20. Shoulder Strap Bolt

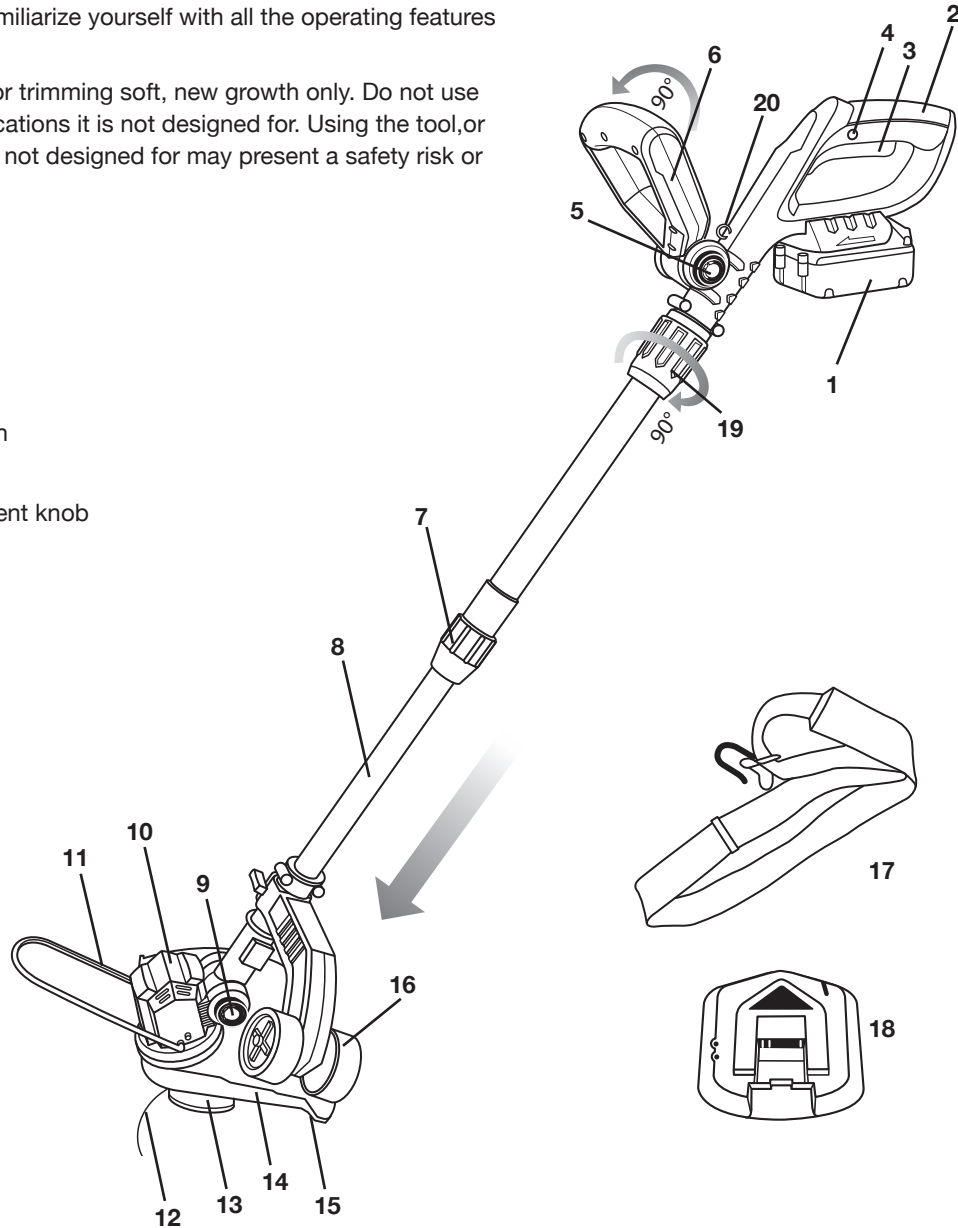

Technical Data

Rated voltage	110-120VAC, 60Hz
Battery Power	20V-1.3Ah
No Load Speed	9000 min ⁻¹
Tool Weight	34.2 lbs./15.5Kg
Cut Diameter (swath)	9.8 inch/250mm

Line Thickness	0.06 inch/1.5mm
Cutting line length	1x15ft (1x4.5m)
Charging time	1 Hour Approx.
Battery pack	1x20V Li-ion

Assembly

(See page 4 for location of parts.)

Fitting the guard and guide wheel

1. Align the 3 screw holes in the guard with the screw holes in the base of the unit.

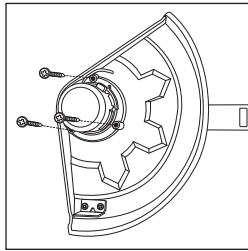

2. Attach the edging wheel to your trimmer by fastening the screw. (*Note, the wheel is attached for edge cutting only.)

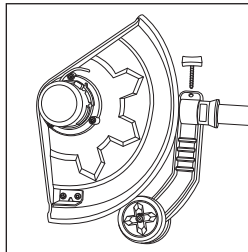

3. Attach the flower guard to the motor housing.

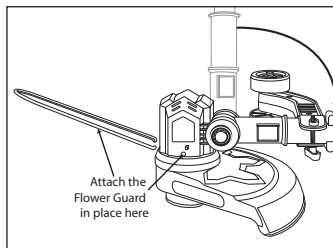

NOTE:

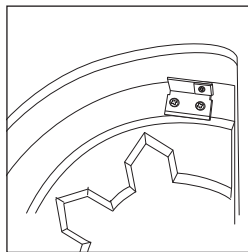

4. Attach shoulder strap to shoulder strap bolt.

Adjusting the telescopic handle

1. Loosen the telescopic shaft adjustment knob, adjust the shaft to a comfortable height. Make sure to tighten the knob once the desired length is suitable.

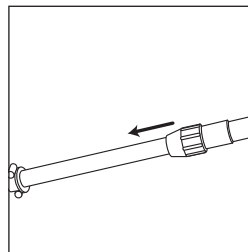

Fitting the secondary handle

To adjust the secondary handle press in the secondary handle buttons and rotate the handle to the desired position then release the buttons to lock it into place.

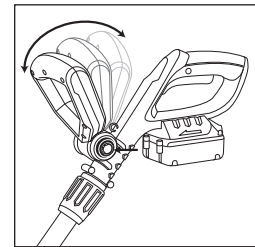

To remove or install battery pack

Locate latches on side of battery pack and depress both sides to release battery pack from your grass trimmer. Remove battery pack from your grass trimmer. After recharging the battery pack insert it into the battery slot of the trimmer.

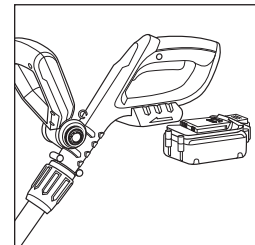

Vertical head adjustment

The head can be adjusted so that it is horizontal with the ground, this feature helps you get access to areas such as under bushes and garden furniture.

The head can be lowered by pressing the head adjustment button (9) and set to the desired angle.

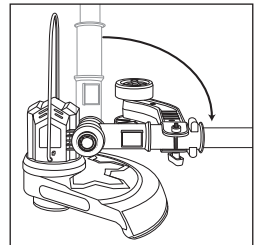

Before starting

The battery pack for this tool has been shipped in a low charge condition. You should charge the battery pack fully before use.

Before use, follow these steps to check that the tool is working properly and the length of the line is correct:

1. Your trigger switch is locked OFF to prevent accidental starting. Depress lock off button (4) then the ON/OFF trigger switch (3) and release lock off button (4), your switch is now ON. To switch OFF just release the ON/OFF trigger switch (3).
2. Examine the general condition of the tool. Inspect the guard, switch, cord set. Check for loose screws, misalignment, binding of moving parts, improper mounting, broken parts and any other condition that may affect its safe operation. If abnormal noise or vibration occurs during operation, turn the line trimmer off immediately and have the problem corrected.
3. Ensure that you are on a flat surface and have secure footing.
4. Check that the line touches or extends beyond the edge of the guard.

Increasing the cutting line

1. Before the first cutting, ensure the cutting line is the correct length. Remove the cover and take out the spool.
2. If the line is too short release the line from the automatic feed spool and at the same time pull the line out so that it extends a few centimeters past the edge of the guard.
3. Reload the spool and lock the cover.
4. During operation to increase the cutting line simply switch the line trimmer off and then on again, this will restore the line to the correct length.

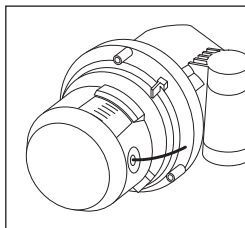
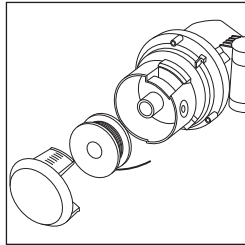

Switching ON and OFF

1. Connect the battery pack to trimmer.
2. Press the lock-off button (4), then press the trigger switch (3).
3. To switch OFF, release the trigger switch.

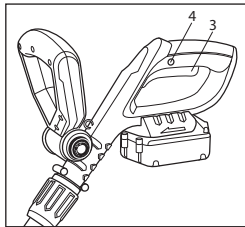

⚠ WARNING. The tool runs for approximately 5 seconds after it has been switched off. Let the motor come to a complete standstill before setting the tool down.

Trimming

⚠ WARNING. Ensure the work area is free from rocks, debris, lines and other foreign objects.

1. Start the trimmer before approaching the grass to be cut.
2. The automatic line feed mechanism releases 12mm from each line when the trimmer reaches a certain speed. If you need the spool to release more than 12mm of line per side, release the trigger until the speed falls beyond the trigger point then press the switch again. As the speed picks up a further 12mm will be released for both lines.
3. Cut the grass by swinging the trimmer from right to left and proceed slowly keeping the trimmer inclined forwards at an angle of about 30°. Light cuts are better than heavy cuts as they allow the cut grass to fall away from the spool preventing the grass from clogging the spool.
4. High grass should be cut in layers always beginning

from the top. Do not cut damp or wet grass. Do not overload your trimmer.

5. Avoid wearing the line out quickly by knocking against hard objects (stones, walls, fences etc.).
6. Be alert for possible kickback when there is impact with hard objects.
7. After finishing the cutting operation, keep the head close to ground level, release the switch, and allow the motor to come to a complete standstill. Place the trimmer on the ground, switch OFF.

NOTE: Periodically clean out the grass between the spool and the rim of the guard to prevent the tool from vibrating.

Using as an edger

NOTE: Always unplug the trimmer before carrying out any maintenance or making any adjustments to the line trimmer.

1. Loosen the handle rotating knob (19) and rotate the shaft 90 degrees, so the handle is facing the opposite direction.
2. Tighten the rotating button (19), ensuring that the handle is in position for edging.
3. Ensure the cutting line is the correct length (see Increasing the cutting line). You can now use the line trimmer as an edger. The wheel guides the line trimmer along the ground.

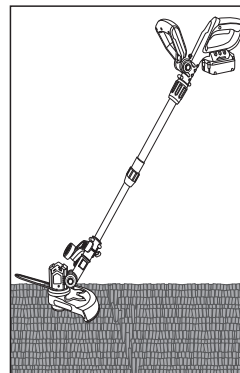

Trimming

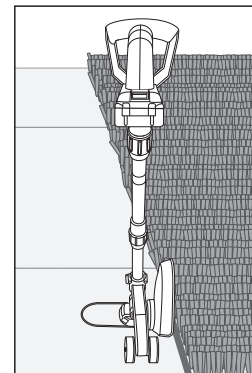

Edging

Changing a line spool

⚠ WARNING. Ensure the cutting line blade cover is replaced.

1. Turn the line trimmer upside down.
2. Hold the spool holder firmly with one hand and with the other hand squeeze the tabs on either side of the spool cover and remove the cover.
3. Remove the empty spool and clean out the spool cover.
4. Align the cutaway sections in the spool opposite the eyelets and thread the line of the new spool through the eyelet in the spool holder and insert the spool.

⚠ CAUTION. After changing the line spool, run the trimmer under no load for at least a minute to verify the line and the tool are both operating correctly. Use only the line spool as recommended by the manufacturer. To order replacement line spool, visit www.snowjoe.com model # TRJ601R3

Maintenance and cleaning

1. Store the tool, instruction manual and accessories in a secure, dry place. Doing so will ensure you always have the information available.
2. Keep the tool's air vents unclogged and clean at all times.
3. Remove dust and dirt regularly. Cleaning is best done with a rag.
4. All bearings and bushes are lubricated for life.
5. Never use harsh agents to clean plastic parts.

⚠ CAUTION. Do not use cleaning agents to clean the plastic parts of the tool. A mild detergent on a damp cloth is recommended. Water must never come into contact with the tool.

General inspection

Regularly check that all the fixing screws are tight. They may vibrate loose after extended use.

Storage

1. Keep the trimmer out of direct sunlight.
2. Do not store in a nylon bag as this can encourage the formation of mold.
3. At the end of the season, give the trimmer a complete cleaning and a thorough check.
4. Do not leave the trimmer resting on the floor for extended periods as it could cause the shape of the guard to alter, posing a safety risk. Hang it off the floor by the top handgrip.

Electrical Safety for Charger

- **Power tool plugs must match the outlet.** Never modify the plug in any way. Do not use any adapter plugs with earthed (grounded) power tools. Unmodified plugs and matching outlets will reduce risk of electric shock.
- **Avoid body contact with earthed or grounded surfaces such as pipes, radiators, ranges and refrigerators.** There is an increased risk of electric shock if your body is earthed or grounded.
- **Do not expose power tools to rain or wet conditions.** Water entering a power tool will increase the risk of electric shock.

- Do not charge appliance in rain, or in wet locations
- Do not use battery operated appliance in rain
- Remove or disconnect battery before servicing, cleaning or removing material from the gardening appliance.
- Use only the battery recommended by manufacturer.
- **Do not dispose of the battery(ies) in a fire.** The cell may explode. Check with local codes for possible special disposal instructions.
- **Do not open or mutilate the battery(ies).** Released electrolyte is corrosive and may cause damage to the eyes or skin. It may be toxic if swallowed.
- **Exercise care in handling batteries in order not to short the battery with conducting materials such as rings, bracelets, and keys.** The battery or conductor may overheat and cause burns.

Charging the battery

The battery pack for this tool has been shipped in a low charge condition. You should charge the battery pack fully before use.

Step 1: Press the battery pack release latch

Step 2: Pull the battery pack, make it separate form the main part of the appliance.

Step 3: Install battery in charger (See Installing battery in charger below).

Step 4: Replace fully charged battery pack and assemble to the main part of the appliance.

⚠ WARNING. Do not use an extension cord.

⚠ WARNING. Charge indoors only.

⚠ WARNING. Do not throw used batteries into a fire or water: it could cause an explosion! Please hand in non-working or used batteries, or tools with built-in batteries, to the environmentally safe disposal unit at a municipal waste-disposal center, or to your dealer.

Installing battery in charger

Turn the battery upside down and slide it into the matching slots in the charger stand. Do not insert the battery the wrong way.

NOTES:

- a) Make sure the battery slides fully into the slots in the charger.
- b) The red indicator light will come ON when the electrical outlet is "live".
- c) The red light will come on and green light flash ,when the battery is properly inserted into the charger stand.
- d) When the green and red light will come on steady, this

means that the battery has been fully recharged. Only then can the power plug be pulled out of the socket. The battery can then be taken out of the base and can be used immediately.

NOTES:

1. A new battery or one that is completely run down should be charged for 1- 1.5 hours (for first charge). After normal use, a battery should be fully charged in about 1 hour.
2. It is normal for the battery charger to hum and be warm to the touch during operation.
3. If the battery does not charge properly, check to make sure the electrical outlet is “live” and that the air surrounding the battery and charger is between 10° C (50° F) and 40° C (105° F).
4. Unplug the charger when not in use and store it in a dry, secure place.
5. Always remove the battery pack and store it in a dry, secure place when the trimmer is not in use.
6. Battery charging should only be carried out indoors.

⚠ WARNING. Never leave a battery on charge once it's warm.

7. Charge LED light indicators

Charge Position	Green Light	Red Light
Free	Off	On
Charging	Flash	On
Fully Charged	On	On
Over Heat Warning	Off	Flash
Battery Malfunction	Off	Flash

Pivoting head for corner working

With quick release locking

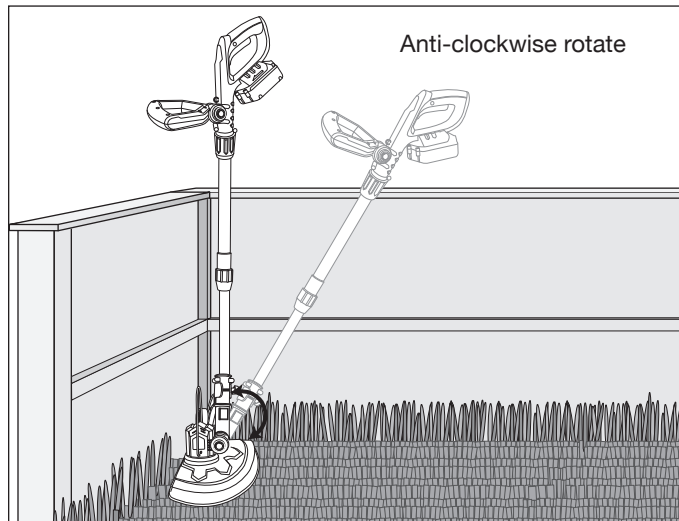

For height adjustment

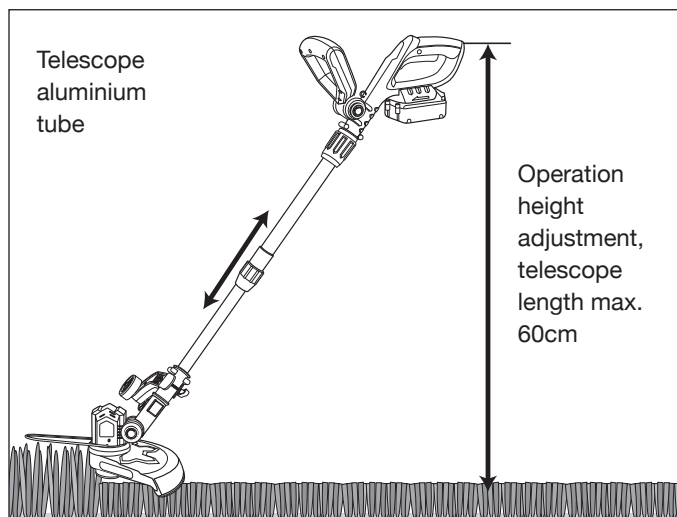

Flower guard

Rotatable steel guard for flowers protection

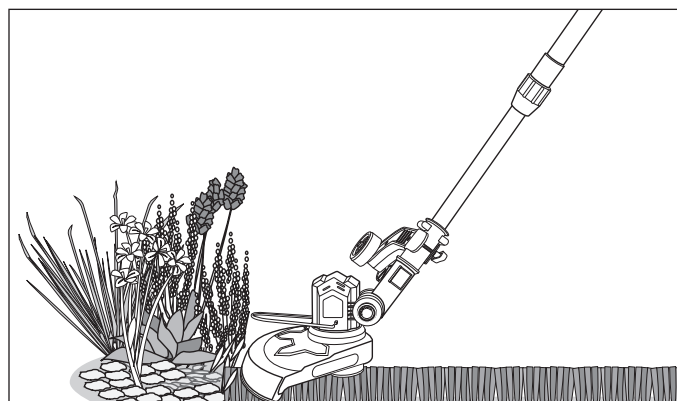

Pivoting head for corner working

With quick release locking

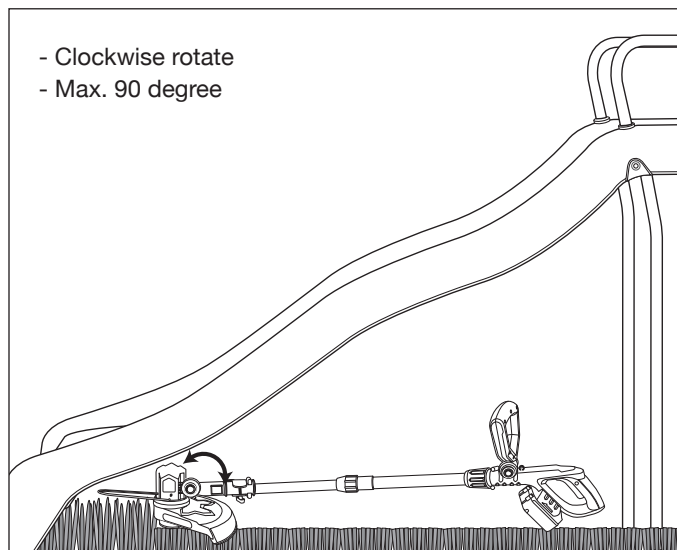

Rotatable front lifting handle

- Quick locking for ease of trimming
- Rotatable angle max. 70 degree

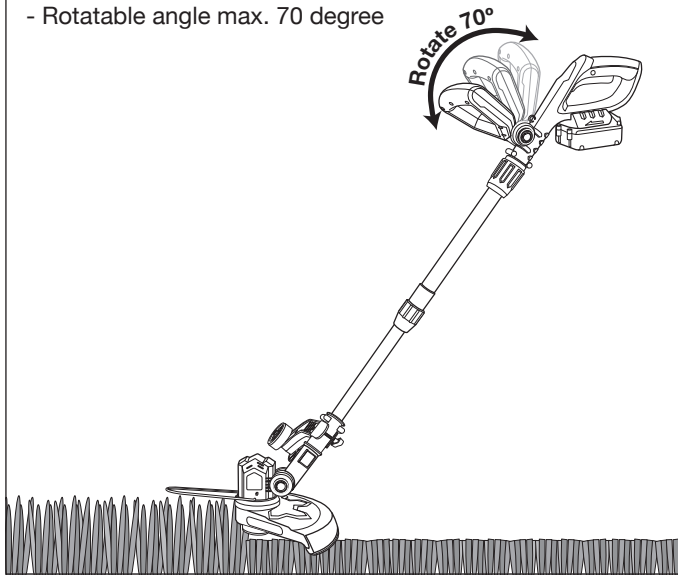

Edging with wheel support

With quick release locking

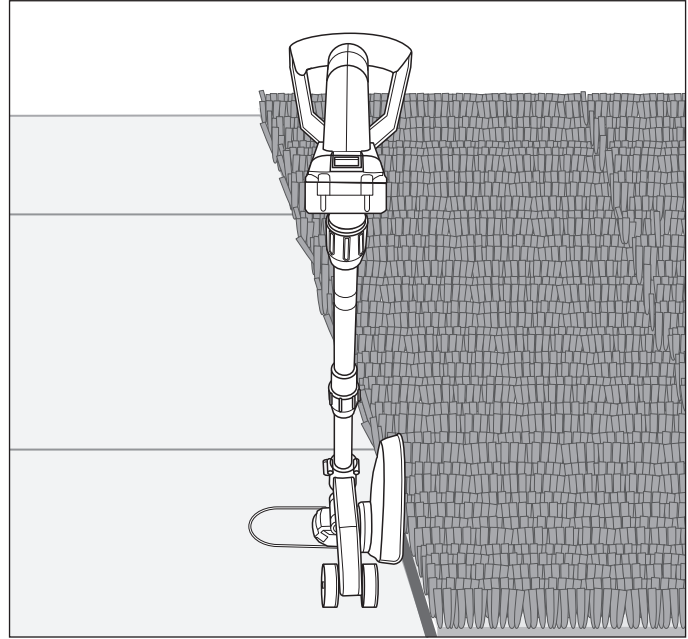

Compact body size

For convenient carrying and storage

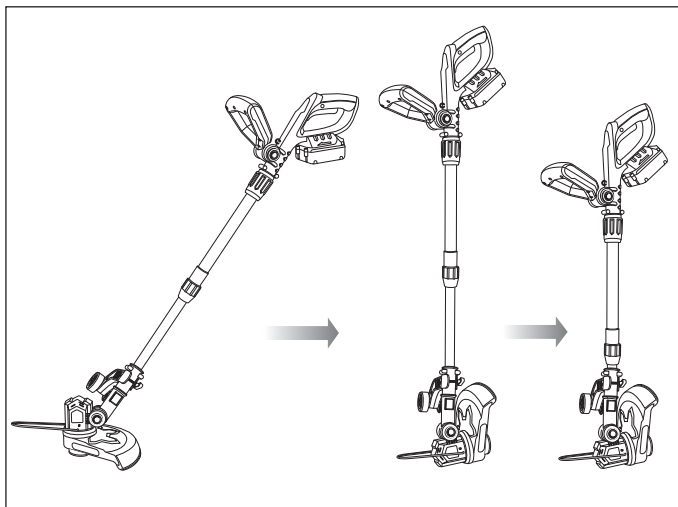

Service and support

If your Cordless Trimmer/Edger requires service or maintenance, please call 1-866-766-9563 for assistance.

Model and Serial Number

When contacting the company or reordering parts, you will need to provide the model and serial numbers of your product. These are found at the bottom of your Cordless Trimmer/Edger. Copy these numbers into the space provided below.

Record the following numbers from the housing or handle of your new product:

Model #:

Serial #:



A Two-Year Full Warranty for residential use in the United States and Canada



General Conditions:

Snow Joe, LLC warrants this product to the original purchaser for two years against defects in material or workmanship when used for normal residential purposes. Snow Joe, LLC will repair any defect in material or workmanship, and repair or replace any defective part, subject to the conditions, limitations, and exclusions set forth herein. Such repair or parts replacement will be free from charge to the original purchaser except noted below.

The duration of the warranty applies only if the product is put to personal use around the household or residence. If the product is put to any business use, commercial or industrial, then the duration of this warranty is 90 days from the date of original purchase. If any product is rented or leased, the duration of the warranty is 90 days from the date of original purchase.

It is the owner's responsibility to perform correctly all maintenance, and minor adjustments explained in the owner's manual.

Electric Products:

To obtain a replacement electric powered unit or repair the existing electric powered unit, you must return the complete unit, postage prepaid, to the Snow Joe Center, 86 Executive Avenue, Edison, NJ 08817

Gasoline / Battery Products:

Limitations

- Batteries are warranted only for the period of 12 months after the date of purchase on a prorated basis. Rechargeable batteries will be replaced free from charge during the first 90 days. After the initial 90 days, batteries will be replaced at prorated cost to the customer
- Idlers, cables, and electrical components are warranted to the original purchaser for use at household or residence for a period of two years

Exclusions

- Snow Joe Brand Engines are covered under this warranty. All other engines and engine accessories are covered only by the engine manufacturer's warranty and are not covered by this warranty
- Parts used that are not genuine Snow Joe parts are not covered by this warranty
- Damages resulting from misuse, alteration, improper assembly, improper adjustment, neglect, or accident which requires repair is not covered under this warranty
- Belts and Augers are not covered under warranty – Belts and Augers wear out and can be purchased at the Snow Joe center.

Snow Joe, LLC may from time to time change the design of its products. Nothing contained in this warranty shall be construed as obligating Snow Joe, LLC to incorporate such design changes into previously manufactured products, nor shall such changes be construed as an admission that previous designs were defective.

This warranty is intended to cover product defects only. Snow Joe, LLC is not liable for indirect, incidental, or consequential damages in connection with the use of the Snow Joe Products covered by this warranty. This warranty does not cover any cost or expense incurred by the purchaser in providing substitute equipment or service during reasonable periods of malfunction or non-use of this product, while waiting for completion of repairs under this warranty. Some states do not allow exclusions of incidental or consequential damages, so the above exclusions may not apply in all states. This warranty gives you specific legal rights in your state, which varies from state to state.

**If you wish to contact Snow Joe, please direct inquiries to the:
Customer Service Department
Snow Joe Center
86 Executive Avenue
Edison, NJ 08817**

Customers who have purchased Snow Joe products exported from the United States and Canada should contact their Snow Joe Distributor (Dealer) to obtain information applicable for your country, province, or state. If for any reason, you are not satisfied with the distributor's service, or if you have difficulty obtaining warranty information, contact your Snow Joe importer. If in the event your efforts are unsatisfactory, please write to the Snow Joe Center at the above address.

If you have any questions about your product warranty, please call 1-866-SNOW-JOE or visit us online at www.snowjoe.com.