



Instruction Sheet

ZVC406 Zone Valve Control

102-397

SUPERSEDES: New

EFFECTIVE: May 1, 2010

Plant ID# 9300-2879

Wiring Diagram

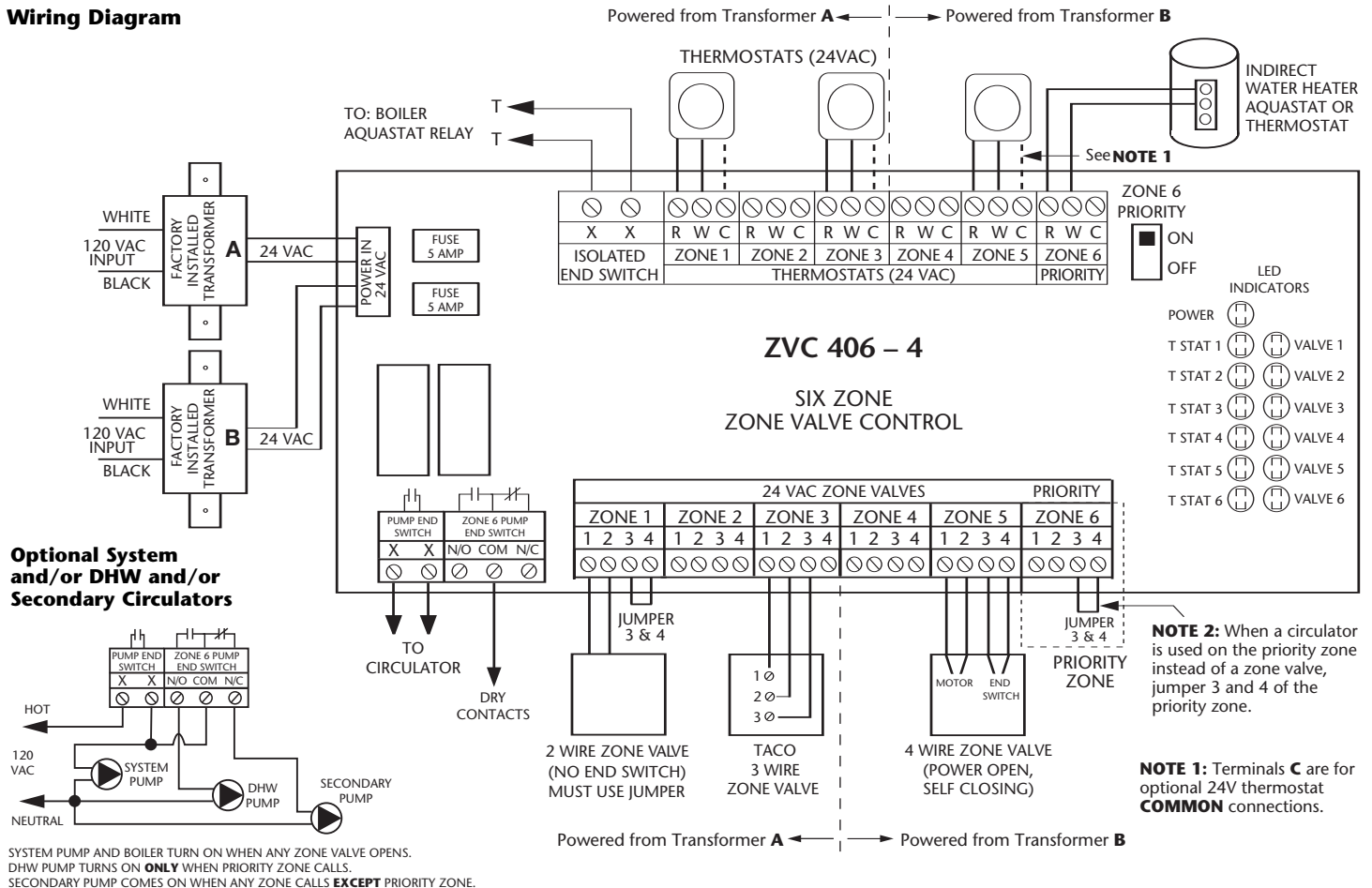

Operation/External Diagnostics: When any thermostat calls for heat, the appropriate zone valve is energized and the yellow light goes on. When the zone valve is fully open, the red light goes on and energizes the end switch relay. The green light should always be on, indicating that power is connected.

Priority Operation: When zone 6 is switched to the priority setting and is actuated, all other zones will stop operation until zone 6 is satisfied. When zone 6 is not switched to priority, all zones will operate independently. **Note:** When a circulator is used on the priority zone instead of a zone valve, jumper 3 and 4 of the priority zone.

Priority Protection Operation: When the priority zone calls continuously for more than one hour, power is returned to all the other zones, allowing each zone to function independently. Once the priority zone is satisfied, the control's auto-reset is activated and the priority zone is again allowed to have priority for up to one hour starting from when it calls next.

The Taco Connection: Combine the reliability of the Taco Zone Valves, Priority Zoning Circulators, Thermostats, and the "00" family of circulators with the advanced features of the Taco Zone Controls to

achieve total system integration. No matter the application, Taco now provides the products to maximize system performance while simplifying both installation and service.

- Features:**
- External Indicator Lights
 - Switchable Priority
 - Priority Protection
 - Simplified Wiring
 - Works with 2, 3, or 4-Wire Zone Valves
 - Compact Design
 - Fuse Protected
 - 100% Factory Tested
 - Isolated End Switch
 - Extra Set of Dry Contacts
 - Contractor Friendly PC Board Layout
 - Universal Thermostat Compatibility
 - UL Approved
 - Sturdy Screw Connections
 - Extended 3 Year Warranty
 - Made in the USA

Specifications:

PRODUCT NUMBER	NUMBER OF ZONES	INPUT VOLTAGE	MAX 24 VAC OUTPUT @ 25°C	TYPE 1 ENCLOSURE WIDTH HEIGHT DEPTH
ZVC406-4	6 with Priority	120/60/1 VAC, 3A	24 VA per Zone 40 VA per Transformer	12 1/4" 8" 3"

The pump end switches are rated 1/2 hp, 5 amps at 120 VAC. The main and priority end switch connections are rated 24 VAC, 1 amp. All thermostat and zone valve connections supply a 24 VAC class 2 output.

WARNING: Wiring connections must be made in accordance with all applicable electrical codes. Use copper wire only. 120 VAC wiring must have a minimum temperature rating of 75°C. Failure to follow this instruction can result in personal injury or death and/or property damage. 12-18 gauge wire recommended for 120 VAC connections, 14-22 gauge wire for thermostat connections, and 14-22 gauge wire for 24 VAC source connections.

This device complies with part 15 of the FCC Rules. Operation is subject to the following two conditions: (1) This device may not cause harmful interference, and (2) this device must accept any interference received, including interference that may cause undesired operation.

2 ZVC403-ZVC406 Zone Controls Connected Together with System Pump

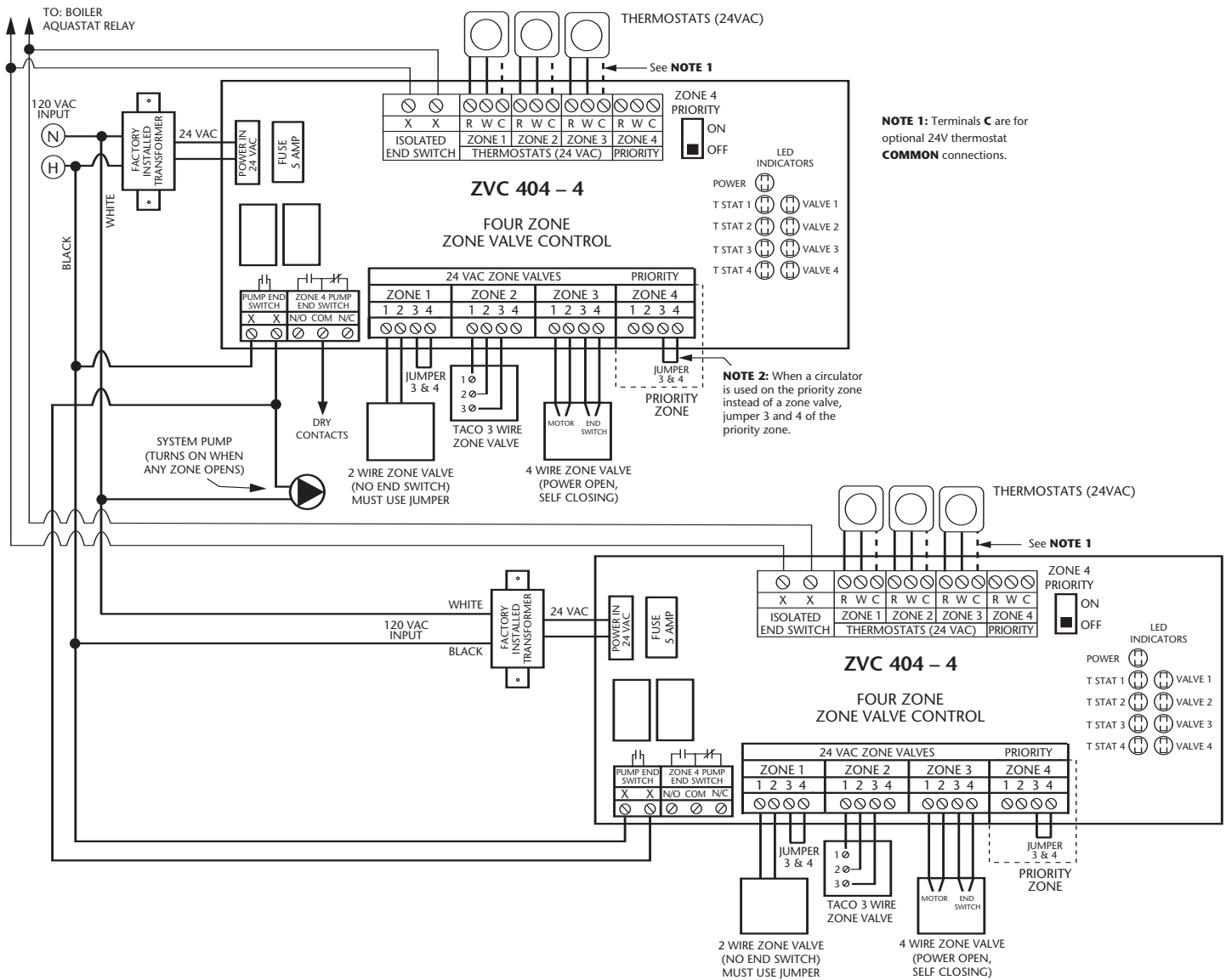

LIMITED WARRANTY STATEMENT

Taco, Inc. will repair or replace without charge (at the company's option) any product or part which is proven defective under normal use within three (3) years from the date of start-up or three (3) years and six (6) months from date of shipment (whichever occurs first).

In order to obtain service under this warranty, it is the responsibility of the purchaser to promptly notify the local Taco stocking distributor or Taco in writing and promptly deliver the subject product or part, delivery prepaid, to the stocking distributor. For assistance on warranty returns, the purchaser may either contact the local Taco stocking distributor or Taco. If the subject product or part contains no defect as covered in this warranty, the purchaser will be billed for parts and labor charges in effect at time of factory examination and repair.

Any Taco product or part not installed or operated in conformity with Taco instructions or which

has been subject to misuse, misapplication, the addition of petroleum-based fluids or certain chemical additives to the systems, or other abuse, will not be covered by this warranty.

If in doubt as to whether a particular substance is suitable for use with a Taco product or part, or for any application restrictions, consult the applicable Taco instruction sheets or contact Taco at [401-942-8000].

Taco reserves the right to provide replacement products and parts which are substantially similar in design and functionally equivalent to the defective product or part. Taco reserves the right to make changes in details of design, construction, or arrangement of materials of its products without notification.

TACO OFFERS THIS WARRANTY IN LIEU OF ALL OTHER EXPRESS WARRANTIES. ANY WARRANTY IMPLIED BY LAW INCLUDING WARRANTIES OF MERCHANTABILITY OR FIT-

NESS IS IN EFFECT ONLY FOR THE DURATION OF THE EXPRESS WARRANTY SET FORTH IN THE FIRST PARAGRAPH ABOVE.

THE ABOVE WARRANTIES ARE IN LIEU OF ALL OTHER WARRANTIES, EXPRESS OR STATUTORY, OR ANY OTHER WARRANTY OBLIGATION ON THE PART OF TACO.

TACO WILL NOT BE LIABLE FOR ANY SPECIAL, INCIDENTAL, INDIRECT OR CONSEQUENTIAL DAMAGES RESULTING FROM THE USE OF ITS PRODUCTS OR ANY INCIDENTAL COSTS OF REMOVING OR REPLACING DEFECTIVE PRODUCTS.

This warranty gives the purchaser specific rights, and the purchaser may have other rights which vary from state to state. Some states do not allow limitations on how long an implied warranty lasts or on the exclusion of incidental or consequential damages, so these limitations or exclusions may not apply to you.

CONTROLS MADE EASY.®

TACO, INC., 1160 Cranston Street, Cranston, RI 02920 Telephone: (401) 942-8000 FAX: (401) 942-2360.

TACO (Canada), Ltd., 8450 Lawson Road, Unit #3, Milton, Ontario L9T 0J8. Telephone: 905/564-9422. FAX: 905/564-9436.

Visit our web site at: <http://www.taco-hvac.com>

Printed in USA

Copyright 2010

TACO, Inc.